



Industry Standard, Flexible Architecture

**OPEN**

Less Heat, Less Power Consumption

**GREEN**

Robust Design, Quality Parts

**STABLE**

Stable and  
Reliable Solution

**Server/Workstation**

Motherboard

# C246 WS



## User Manual

English

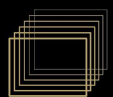

Version 1.0

Published April 2019

Copyright©2019 ASRock Rack Inc. All rights reserved.

## Copyright Notice:

No part of this documentation may be reproduced, transcribed, transmitted, or translated in any language, in any form or by any means, except duplication of documentation by the purchaser for backup purpose, without written consent of ASRock Rack Inc.

Products and corporate names appearing in this documentation may or may not be registered trademarks or copyrights of their respective companies, and are used only for identification or explanation and to the owners' benefit, without intent to infringe.

## Disclaimer:

Specifications and information contained in this documentation are furnished for informational use only and subject to change without notice, and should not be constructed as a commitment by ASRock Rack. ASRock Rack assumes no responsibility for any errors or omissions that may appear in this documentation.

With respect to the contents of this documentation, ASRock Rack does not provide warranty of any kind, either expressed or implied, including but not limited to the implied warranties or conditions of merchantability or fitness for a particular purpose.

In no event shall ASRock Rack, its directors, officers, employees, or agents be liable for any indirect, special, incidental, or consequential damages (including damages for loss of profits, loss of business, loss of data, interruption of business and the like), even if ASRock Rack has been advised of the possibility of such damages arising from any defect or error in the documentation or product.



This device complies with Part 15 of the FCC Rules. Operation is subject to the following two conditions:

- (1) this device may not cause harmful interference, and
- (2) this device must accept any interference received, including interference that may cause undesired operation.

## CALIFORNIA, USA ONLY

The Lithium battery adopted on this motherboard contains Perchlorate, a toxic substance controlled in Perchlorate Best Management Practices (BMP) regulations passed by the California Legislature. When you discard the Lithium battery in California, USA, please follow the related regulations in advance.

“Perchlorate Material-special handling may apply, see [www.dtsc.ca.gov/hazardouswaste/perchlorate](http://www.dtsc.ca.gov/hazardouswaste/perchlorate)”

**ASRock Rack's Website: [www.ASRockRack.com](http://www.ASRockRack.com)**

## Contact Information

If you need to contact ASRock Rack or want to know more about ASRock Rack, you're welcome to visit ASRock Rack's website at [www.ASRockRack.com](http://www.ASRockRack.com); or you may contact your dealer for further information.

### **ASRock Rack Incorporation**

6F., No.37, Sec. 2, Jhongyang S. Rd., Beitou District,

Taipei City 112, Taiwan (R.O.C.)

The terms HDMI™ and HDMI High-Definition Multimedia Interface, and the HDMI logo are trademarks or registered trademarks of HDMI Licensing LLC in the United States and other countries.



## Contents

<b>Chapter 1 Introduction</b>	<b>1</b>
1.1 Package Contents	1
1.2 Specifications	2
1.3 Unique Features	5
1.4 Motherboard Layout	6
1.5 Onboard LED Indicators	9
1.6 I/O Panel	10
1.7 Block Diagram	11
<b>Chapter 2 Installation</b>	<b>12</b>
2.1 Screw Holes	12
2.2 Pre-installation Precautions	12
2.3 Installing the CPU	13
2.4 Installing the CPU Fan and Heatsink	15
2.5 Installation of Memory Modules (DIMM)	16
2.6 Expansion Slots (PCI and PCI Express Slots)	18
2.7 Jumper Setup	19
2.8 Onboard Headers and Connectors	20
2.9 Dr. Debug	26
2.10 Driver Installation Guide	32
2.11 Dual LAN and Teaming Operation Guide	33
2.12 M.2_SSD (NGFF) Module Installation Guide (M2_1 / M2_2)	34
<b>Chapter 3 UEFI Setup Utility</b>	<b>39</b>
3.1 Introduction	39

3.1.1	UEFI Menu Bar	39
3.1.2	Navigation Keys	40
3.2	Main Screen	41
3.3	Advanced Screen	42
3.3.1	CPU Configuration	43
3.3.2	DRAM Configuration	46
3.3.3	Chipset Configuration	47
3.3.4	Storage Configuration	50
3.3.5	ACPI Configuration	52
3.3.6	USB Configuration	53
3.3.7	Super IO Configuration	54
3.3.8	Serial Port Console Redirection	55
3.3.9	H/W Monitor	58
3.3.10	Runtime Error Logging	60
3.3.11	Intel ME Configuration	61
3.3.12	Intel(R) Bios Guard Technology	62
3.3.13	Instant Flash	63
3.4	Security	64
3.4.1	Key Management	65
3.5	Boot Screen	69
3.5.1	CSM Parameters	71
3.6	Event Logs	73
3.7	Exit Screen	75

<b>Chapter 4 Software Support</b>	<b>76</b>
4.1 Install Operating System	76
4.2 Support CD Information	76
4.2.1 Running The Support CD	76
4.2.2 Drivers Menu	76
4.2.3 Utilities Menu	76
4.2.4 Contact Information	76
<b>Chapter 5 Troubleshooting</b>	<b>77</b>
5.1 Troubleshooting Procedures	77
5.2 Technical Support Procedures	79
5.3 Returning Merchandise for Service	79

# Chapter 1 Introduction

Thank you for purchasing ASRock Rack C246 WS motherboard, a reliable motherboard produced under ASRock Rack's consistently stringent quality control. It delivers excellent performance with robust design conforming to ASRock Rack's commitment to quality and endurance.

In this manual, chapter 1 and 2 contains introduction of the motherboard and step-by-step guide to the hardware installation. Chapter 3 and 4 contains the configuration guide to BIOS setup and information of the Support CD.



*Because the motherboard specifications and the BIOS software might be updated, the content of this manual will be subject to change without notice. In case any modifications of this manual occur, the updated version will be available on ASRock Rack website without further notice. You may find the latest memory and CPU support lists on ASRock Rack website as well. ASRock Rack's Website: [www.ASRockRack.com](http://www.ASRockRack.com)*

*If you require technical support related to this motherboard, please visit our website for specific information about the model you are using.  
<http://www.asrockrack.com/support/>*

## 1.1 Package Contents

- ASRock Rack C246 WS Motherboard  
(ATX Form Factor: 12-in x 9.6-in, 30.5 cm x24.4 cm)
- Support CD
- Quick Installation Guide
- 1 x SATA3 Cable (60cm)
- 1 x I/O Shield
- 2 x Screws for M.2 Sockets



*If any items are missing or appear damaged, contact your authorized dealer.*

## 1.2 Specifications

<b>C246 WS</b>	
<b>MB Physical Status</b>	
Form Factor	ATX
Dimension	12" x 9.6" (30.5 cm x24.4 cm)
<b>Processor System</b>	
CPU	Supports Intel® Xeon® E-2100 Series Processors
Socket	Single Socket LGA1151
Chipset	Intel® C246
<b>System Memory</b>	
Capacity	- 4 x 288-pin DDR4 DIMM slots - Support up to 64GB DDR4 ECC/non-ECC UDIMM
Type	- Dual Channel DDR4 memory technology - Supports DDR4 ECC/non-ECC UDIMM (client O.S only)
DIMM Size Per DIMM	ECC and non-EDD UDIMM : 16GB, 8GB, 4GB
DIMM	- Non-ECC UDIMM: 2666/2400/2133 MHz
Frequency	- ECC UDIMM: 2666/2400/2133 MHz
Voltage	1.2V
<b>Expansion Slot</b>	
PCIe 3.0 x 16	SLOT6: Gen3 x16 link, auto switch to x8 link if SLOT4 is occupied SLOT4: Gen3 x16 link (ME), Gen3 x8 link(EE)
PCIe 3.0 x 8	SLOT2: Gen3 x8 link (ME), Gen3 x4 link(EE); shared with M2_2
PCIe 3.0 x 1	SLOT7
PCI 32 bit	PCI1
<b>Storage</b>	
SATA Controller	Intel® C246 : 8 x SATA3 6.0 Gb/s, support RAID 0, 1, 5, 10
Additional Controller	Marvell SE9172: 4 x SATA3 6.0 Gb/s, support RAID 0, 1, 5, 10
<b>Audio</b>	
Audio Codec	Realtek ALC892
<b>Ethernet</b>	
Interface	1000 /100 /10 Mbps
On Board	2 x RJ45 GLAN by Intel® i210 + Intel® i219LM - Supports Wake-On-LAN - Supports Energy Efficient Ethernet 802.3az - Supports Dual LAN with Teaming function - Supports PXE



Management	
Features	- Watch Dog - NMI
Graphics	
Controller	CPU pGFX
Rear Panel I/O	
USB 3.1 Gen1 Ports	3 x TypeA + 1 x TypeC ports
VGA Port	1 x D-Sub
Serial Port	1
HDMI Port	1
Display Port	1
LAN Port	- RJ45: 2 x GLAN(by Intel® i210 + Intel® i219LM) - LAN Ports with LED (ACT/LINK LED and SPEED LED)
Audio	1 (5+1 jack)
Internal Connector	
Auxiliary Panel Header	1 (includes chassis intrusion, front LAN LED)
TPM Header	1
Fan Header	6x Fan
ATX Power	1 (24-pin) + 1 (8-pin)
USB 3.0 Header	1 (support 2 x USB 3.0 ports)
USB 2.0 Header	3 (supports 6 x USB 2.0 ports)
M.2	M2_1: (2230/2242/2260/2280/22110, Supports PCIE3.0(X4)/SATA3) M2_2: (2230/2242/2260/2280/22110, Supports PCIE3.0(X4)) M2_3 (BTO) : (2230, WiFi/ BT antenna)
SATADOM	1 (shared with M.2)
80 debug port LED	1
Buzzer	1
ClearCMOS	1 (short pad)
SGPIO	2
Front Panel	1 (RST, PWRBTN, HDDLED, PWRLED)
Speaker	1 (4pin)
TR1	1
Audio	1
NMI Button Header	1

System BIOS	
BIOS Type	256 Mb AMI UEFI Legal BIOS
BIOS Features	<ul style="list-style-type: none"> <li>- Plug and Play (PnP)</li> <li>- ACPI 2.0 Compliance Wake Up Events</li> <li>- SMBIOS 2.8.0 Support</li> <li>- ASRock Rack Instant Flash</li> </ul>
Hardware Monitor	
Temperature	<ul style="list-style-type: none"> <li>- CPU/PCH Temperature Sensing</li> <li>- MB/Card side/TR1 Temperature Sensing</li> </ul>
Fan	<ul style="list-style-type: none"> <li>- CPU Quiet Fan (Allow Chassis Fan Speed Auto-Adjust by CPU Temperature)</li> <li>- Fan Multi-Speed Control</li> </ul>
Voltage	Voltage Monitoring: +12V, +5V, +3.3V, CPU Vcore, VCCM, VCCIO, VCCSA, VCCST_SFR, V1.0M, 3VSB
Support OS	
OS	<p>Microsoft® Windows*</p> <ul style="list-style-type: none"> <li>- Windows 10 (64bit)</li> </ul> <p>Linux*</p> <ul style="list-style-type: none"> <li>- RedHat Enterprise Linux Server 6.9 (64 bit) / 7.4 (64 bit) / 8.1 (64 bit)</li> <li>- SUSE Enterprise Linux Server 11 SP4 (64 bit) / 12 SP3 (64 bit)</li> <li>- Ubuntu 16.04 (64 bit) / 18.04 (64 bit)</li> </ul> <p>Virtual</p> <ul style="list-style-type: none"> <li>- VMWare® ESXi 6.5 u1</li> </ul> <p><i>*Please refer to our website for the latest OS support list.</i>  <i>*On the Ubuntu 16.04 (64bit)/18.04 (64 bit) system, Intel Raid mode only supports UEFI BOOT.</i>  <i>*Marvell RAID mode does not support Linux OS installation.</i>  <i>*In RedHat Enterprise Linux Server 7.4 (64 bit), please disable the Marvell 9172 controller in the BIOS.</i></p>
Environment	
Temperature	<p>Operation temperature: 10°C ~ 35°C / Non operation temperature: -40°C ~ 70°C</p>

NOTE: Please refer to our website for the latest specifications.



This motherboard supports Wake from on Board LAN. To use this function, please make sure that the "Wake on Magic Packet from power off state" is enabled in Device Manager > Intel® Ethernet Connection > Power Management. And the "PCI Devices Power On" is enabled in UEFI SETUP UTILITY > Advanced > ACPI Configuration. After that, onboard LAN1&2 can wake up S5 under OS.



If you install Intel® LAN utility or Marvell SATA utility, this motherboard may fail Windows® Hardware Quality Lab (WHQL) certification tests. If you install the drivers only, it will pass the WHQL tests.

## 1.3 Unique Features

ASRock Rack Instant Flash is a BIOS flash utility embedded in Flash ROM. This convenient BIOS update tool allows you to update system BIOS without entering operating systems first like MS-DOS or Windows<sup>®</sup>. With this utility, you can press the <F6> key during the POST or the <F2> key to enter into the BIOS setup menu to access ASRock Rack Instant Flash. Just launch this tool and save the new BIOS file to your USB flash drive, floppy disk or hard drive, then you can update your BIOS only in a few clicks without preparing an additional floppy diskette or other complicated flash utility. Please be noted that the USB flash drive or hard drive must use FAT32/16/12 file system.



No.	Description
1	Rear Fan Connector (REAR_FAN1)
2	ATX 12V Power Connector (ATX12V1)
3	ATX Power Connector (ATXPWR1)
4	2 x 288-pin DDR4 DIMM Slots (DDR4_A1, DDR4_B1, Blue)*
5	2 x 288-pin DDR4 DIMM Slots (DDR4_A2, DDR4_B2, White)*
6	CPU Fan Connector (CPU_FAN1)
7	Front Fan Connector (FRNT_FAN1)
8	Front Fan Connector (FRNT_FAN2)
9	Front Fan Connector (FRNT_FAN3)
10	Front Fan Connector (FRNT_FAN4)
11	SATA SGPIO Connector (SATA_SGPIO1)
12	SATA SGPIO Connector (SATA_SGPIO2)
13	SATA DOM Power Header (SATA_PWR1)
14	USB 2.0 Header (USB_5_6)
15	USB 3.0 Header (USB3_1_2)
16	SATA DOM Power Jumper (SATAPWR1)
17	SATA3 DOM Connector (SATA_0), Red
18	SATA3 Connector (SATA_1)
19	SATA3 Connector (SATA_3)
20	SATA3 Connector (SATA_2)
21	SATA3 Connector (SATA_5)
22	SATA3 Connector (SATA_4)
23	SATA3 Connector (SATA_7)
24	SATA3 Connector (SATA_6)
25	SATA3 Connector (M_SATA_1)
26	SATA3 Connector (M_SATA_0)
27	SATA3 Connector (M_SATA_3)
28	SATA3 Connector (M_SATA_2)
29	System Panel Header (PANEL1)
30	Auxiliary Panel Header (AUX_PANEL1)
31	USB 2.0 Header (USB_3_4)
32	TPM Header (TPM1)
33	USB 2.0 Header (USB_1_2)

No.	Description
34	Non Maskable Interrupt Button (NMI_BTN1)
35	Flash Descriptor Security Override Jumper (SEC_OR1)
36	Speaker Header (SPEAKER1)
37	PCI Express Graphics Configuration Jumper (PEG_CFG1)
38	Thermal Sensor Header (TR1)
39	Front Panel Audio Header (HD_AUDIO1)
40	M.2 Socket (M2_2) (Type 2230/2242/2260/2280/22110)
41	M.2 Socket (M2_3) (Type 2230) (optional: BTO)
42	M.2 Socket (M2_1) (Type 2230/2242/2260/2280/22110)
43	Clear CMOS Pad (CLRMOSS1)

*\*For DIMM installation and configuration instructions, please see p.16 (Installation of Memory Modules (DIMM)) for more details.*

## 1.5 Onboard LED Indicators

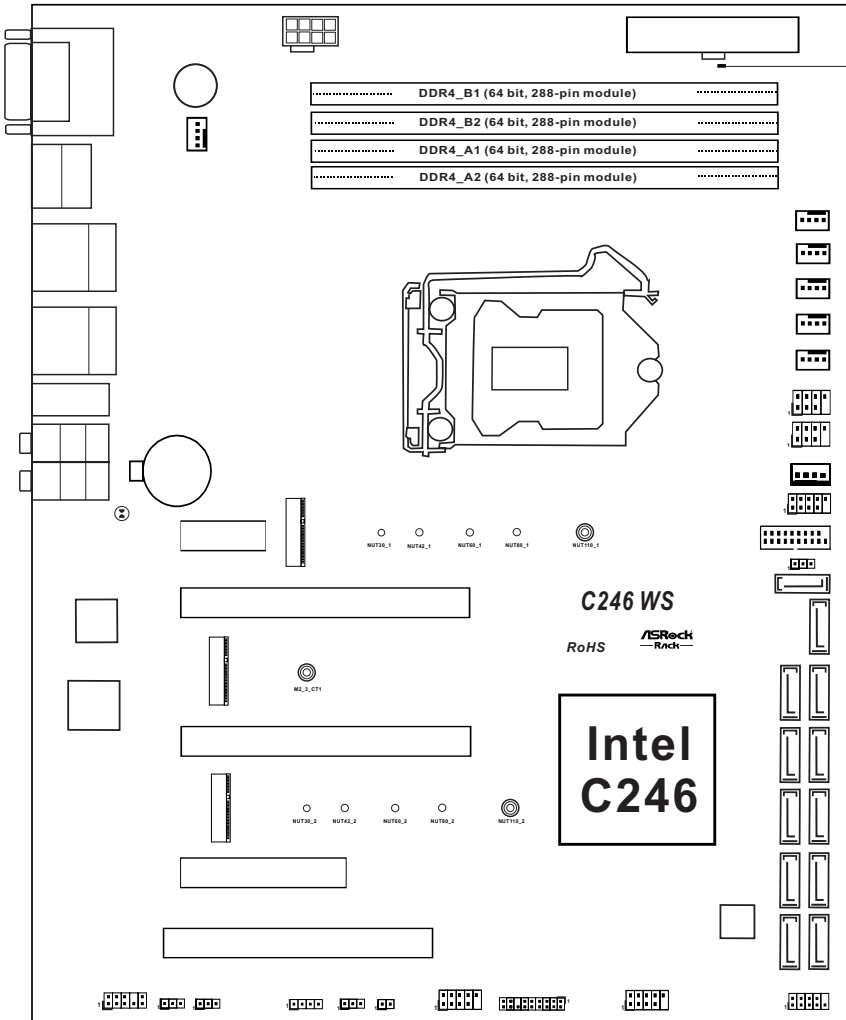

No.	Item	Status	Description
1	SB_PWR1	Green	STB PWR ready

## 1.6 I/O Panel

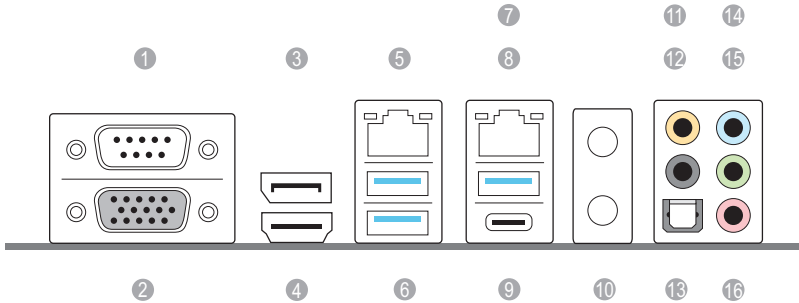

No.	Description	No.	Description
1	Serial Port (COM1)	9	USB 3.1 Gen1 Type C Port (USB3_3)
2	VGA Port (VGA1)	10	Antenna Bracket <i>(optional: Build To Order)</i>
3	Display Port (DISPLAY1)	11	Central / Bass (Orange)
4	HDMI Port (HDMI1)	12	Rear Speaker (Black)
5	LAN RJ-45 Port (LAN1)*	13	Optical SPDIF Out Port (SPDIF1)
6	USB 3.1 Gen1 Ports (USB3_1_2)	14	Line In (Light Blue)
7	LAN RJ-45 Port (LAN2)*	15	Front Speaker (Lime)
8	USB 3.1 Gen1 Type A Port (USB3_4)	16	Microphone (Pink)

### LAN Port LED Indications

\*There are two LED next to the LAN port. Please refer to the table below for the LAN port LED indications.

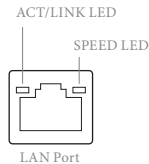

### LAN Port LED Indications

Activity / Link LED		Speed LED	
Status	Description	Status	Description
Off	No Link	Off	10M bps connection or no link
Blinking Yellow	Data Activity	Yellow	100M bps connection
On	Link	Green	1Gbps connection



## 1.7 Block Diagram

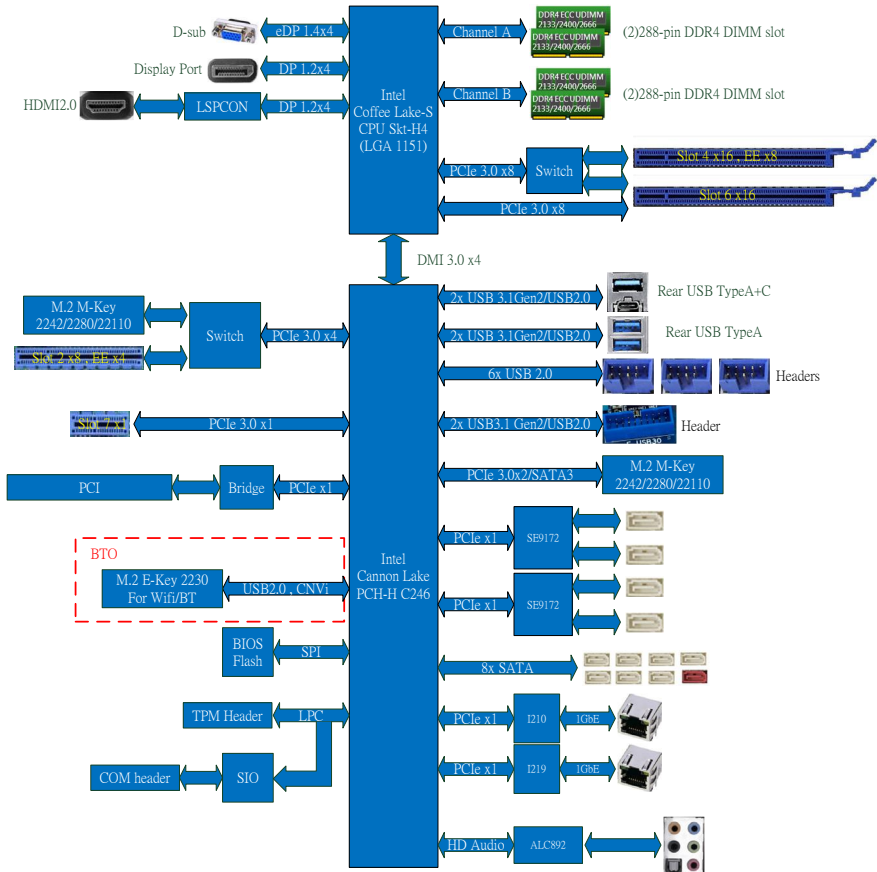

# Chapter 2 Installation

This is an ATX form factor (12" x 9.6", 30.5 cm x 24.4 cm) motherboard. Before you install the motherboard, study the configuration of your chassis to ensure that the motherboard fits into it.



*Make sure to unplug the power cord before installing or removing the motherboard. Failure to do so may cause physical injuries to you and damages to motherboard components.*

## 2.1 Screw Holes

Place screws into the holes indicated by circles to secure the motherboard to the chassis.



*Do not over-tighten the screws! Doing so may damage the motherboard.*

## 2.2 Pre-installation Precautions

Take note of the following precautions before you install motherboard components or change any motherboard settings.

1. Unplug the power cord from the wall socket before touching any components.
2. To avoid damaging the motherboard's components due to static electricity, NEVER place your motherboard directly on the carpet or the like. Also remember to use a grounded wrist strap or touch a safety grounded object before you handle the components.
3. Hold components by the edges and do not touch the ICs.
4. Whenever you uninstall any component, place it on a grounded anti-static pad or in the bag that comes with the component.
5. When placing screws into the screw holes to secure the motherboard to the chassis, please do not over-tighten the screws! Doing so may damage the motherboard.



*Before you install or remove any component, ensure that the power is switched off or the power cord is detached from the power supply. Failure to do so may cause severe damage to the motherboard, peripherals, and/or components.*

## 2.3 Installing the CPU



1. Before you insert the 1151-Pin CPU into the socket, please check if the PnP cap is on the socket, if the CPU surface is unclean, or if there are any bent pins in the socket. Do not force to insert the CPU into the socket if above situation is found. Otherwise, the CPU will be seriously damaged.
2. Unplug all power cables before installing the CPU.

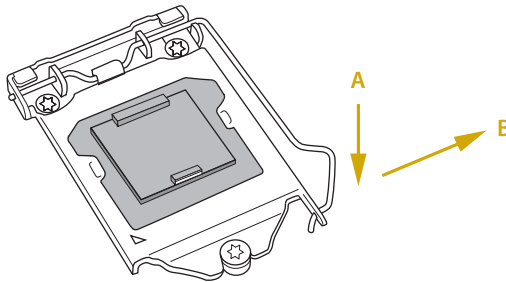
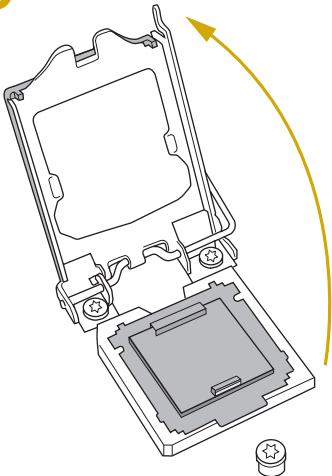
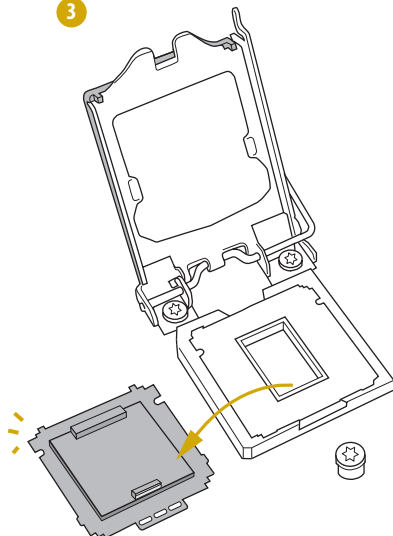

Illustrations in this User Manual are provided for reference only and may slightly differ from actual product appearances.

**1****2****3**

4

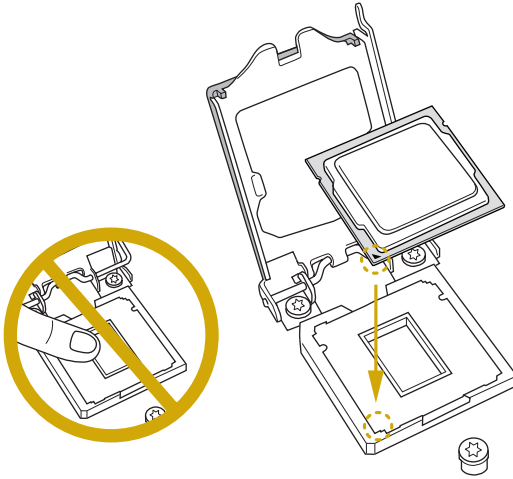

5

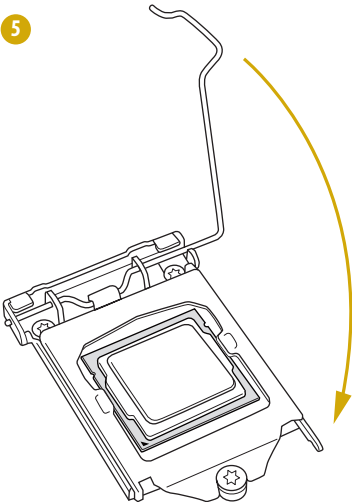

6

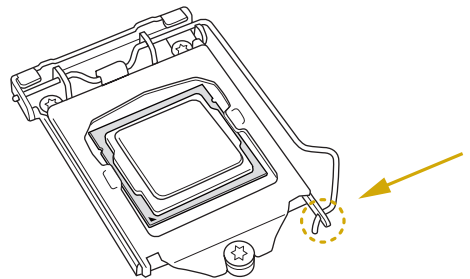

Please save and replace the cover if the processor is removed. The cover must be placed if you wish to return the motherboard for after service.

## 2.4 Installing the CPU Fan and Heatsink

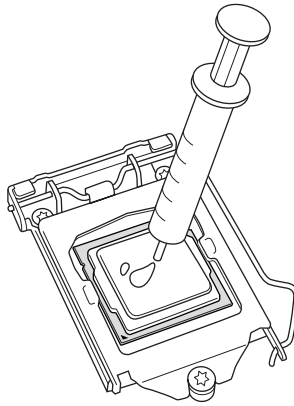
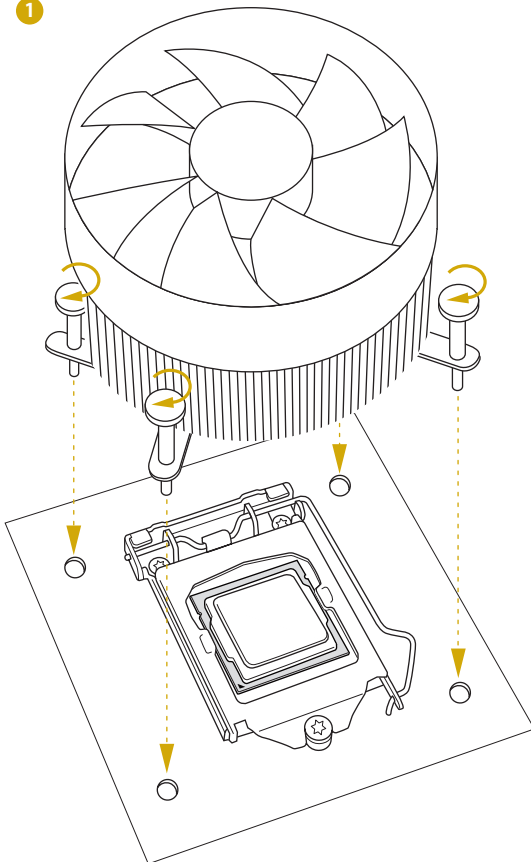
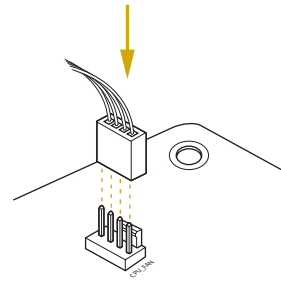
**1****2**

## 2.5 Installation of Memory Modules (DIMM)

This motherboard provides four 288-pin DDR4 (Double Data Rate 4) DIMM slots, and supports Dual Channel Memory Technology.



1. For dual channel configuration, you always need to install identical (the same brand, speed, size and chip-type) DDR4 DIMM pairs.
2. It is unable to activate Dual Channel Memory Technology with only one or three memory module installed.
3. It is not allowed to install a DDR, DDR2 or DDR3 memory module into a DDR4 slot; otherwise, this motherboard and DIMM may be damaged.

### Memory Configuration

	DDR4_A2	DDR4_A1	DDR4_B2	DDR4_B1
1		Populated		
2				Populated
3	Populated	Populated		
4			Populated	Populated
5	Populated	Populated		Populated
6		Populated	Populated	Populated
7		Populated		Populated
8	Populated	Populated	Populated	Populated

\*Number 7 and 8 are for Dual Channel Memory Configuration.



The DIMM only fits in one correct orientation. It will cause permanent damage to the motherboard and the DIMM if you force the DIMM into the slot at incorrect orientation.

1

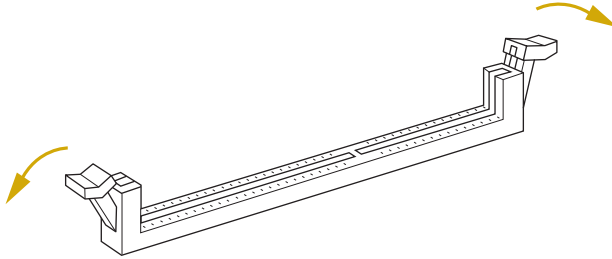

2

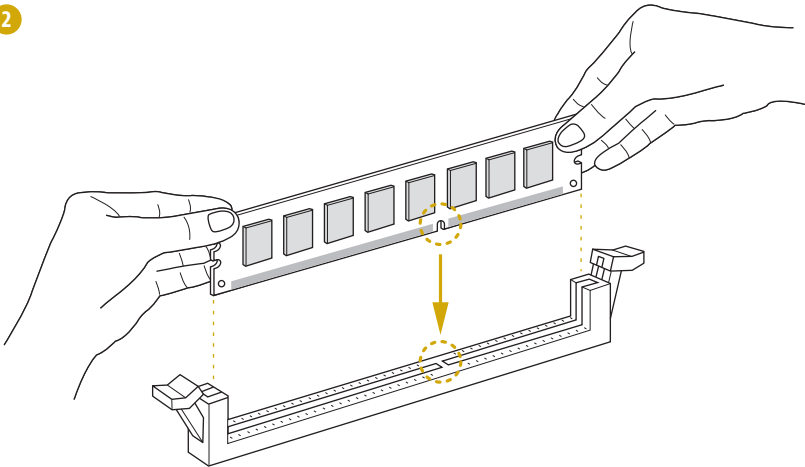

3

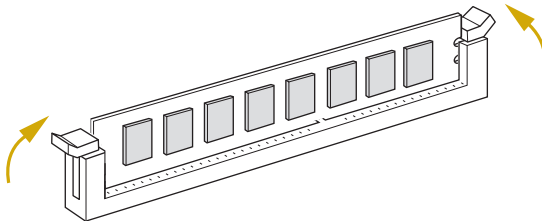

The DIMM only fits in one correct orientation. It will cause permanent damage to the motherboard and the DIMM if you force the DIMM into the slot at incorrect orientation.

## 2.6 Expansion Slots (PCI and PCI Express Slots)

There is one PCI and 4 PCI Express slots on this motherboard.

### PCI slot:

The PCI1 is used to install expansion cards that have 32-bit PCI interface.

### PCIe slot:

PCIe2 (PCIe 3.0 x8 slot) is used for PCI Express x8 lane width cards.

PCIe4 (PCIe 3.0 x16 slot) is used for PCI Express x16 lane width cards.

PCIe6 (PCIe 3.0 x16 slot) is used for PCI Express x16 lane width cards.

PCIe7 (PCIe 3.0 x1 slot) is used for PCI Express x1 lane width cards.

Slot	Generation	Mechanical	Electrical	Source
PCIe 7	3.0	x1	x1	PCH
PCIe 6	3.0	x16	x16	CPU
PCIe 4	3.0	x16	x8	CPU
PCIe 2	3.0	x8	x4	PCH

*\*The M.2 slot (M2\_2) is shared with the PCIe2 slot. When M2\_2 is populated with a M.2 PCI Express module, PCIe2 is disabled.*

### PCI Express Slot Configuration

	PCIe 4	PCIe6
Single PCIe Card	x0	x16
Two PCIe Cards	x8	x8

### Installing an expansion card







- Step 1. Before installing an expansion card, please make sure that the power supply is switched off or the power cord is unplugged. Please read the documentation of the expansion card and make necessary hardware settings for the card before you start the installation.
- Step 2. Remove the system unit cover (if your motherboard is already installed in a chassis).
- Step 3. Remove the bracket facing the slot that you intend to use. Keep the screws for later use.
- Step 4. Align the card connector with the slot and press firmly until the card is completely seated on the slot.
- Step 5. Fasten the card to the chassis with screws.
- Step 6. Replace the system cover.

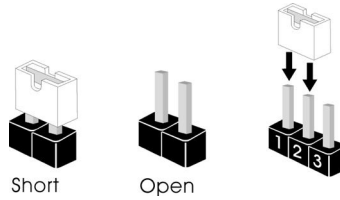

## 2.7 Jumper Setup

The illustration shows how jumpers are setup. When the jumper cap is placed on the pins, the jumper is “Short”. If no jumper cap is placed on the pins, the jumper is “Open”. The illustration shows a 3-pin jumper whose pin1 and pin2 are “Short” when a jumper cap is placed on these 2 pins.



PCI Express Graphics Configuration Jumper (PEG_CFG1) (see p.6, No. 37)	 Normal Mode (Default)	 PCIE6 force @ x8 x8
Security Override Jumper (3-pin SEC_OR1) (see p.6, No. 35)	 Descriptor Security Override	 Not override (Default)
SATA DOM Power Jumper (3-pin SATAPWR1) (see p.6, No. 16)	 SATA DOM (SATA_0) requires 5V power supply	 SATA DOM (SATA_0) does NOT require 5V power supply (Default)



Consult the documentation that comes with your SATA DOM and check whether or not Pin 7 requires 5V power supply.

If the connected SATA DOM requires 5V power supply, move the jumper caps placed on the SATA DOM Power Jumper (SATAPWR1) from pins 2-3 (default) to pins 1-2.

If the connected SATA DOM does NOT require 5V power supply, connect the SATA DOM power cable to the SATA DOM power header (SATA\_PWR1) and there is no need to change the default jumper setting of the SATA DOM Power Jumper (pins 2-3).

**Warning!** Incorrect setting of the SATA DOM Power Jumper (SATAPWR1) may cause damage to the motherboard or your SATA DOM.

## 2.8 Onboard Headers and Connectors



Onboard headers and connectors are NOT jumpers. Do NOT place jumper caps over these headers and connectors. Placing jumper caps over the headers and connectors will cause permanent damage to the motherboard.

System Panel Header  
(9-pin PANEL1)  
(see p.6, No. 29)

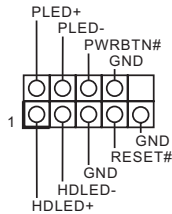

Connect the power switch, reset switch and system status indicator on the chassis to this header according to the pin assignments. Particularly note the positive and negative note the positive and negative pins before connecting the cables.



**PWRBTN (Power Switch):**

Connect to the power switch on the chassis front panel. You may configure the way to turn off your system using the power switch.

**RESET (Reset Switch):**

Connect to the reset switch on the chassis front panel. Press the reset switch to restart the computer if the computer freezes and fails to perform a normal restart.

**PLED (System Power LED):**

Connect to the power status indicator on the chassis front panel. The LED is on when the system is operating. The LED is off when the system is in S4 sleep state or powered off (S5).

**HDLED (Hard Drive Activity LED):**

Connect to the hard drive activity LED on the chassis front panel. The LED is on when the hard drive is reading or writing data.

The front panel design may differ by chassis. A front panel module mainly consists of power switch, reset switch, power LED, hard drive activity LED, speaker and etc. When connecting your chassis front panel module to this header, make sure the wire assignments and the pin assignments are matched correctly.

Auxiliary Panel Header  
(18-pin AUX\_PANEL1)  
(see p.6, No. 30)

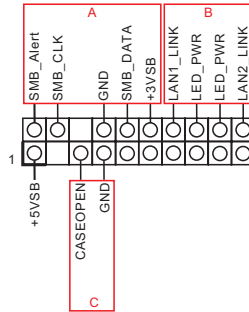

This header supports multiple functions on the front panel, including the front panel SMB, internet status indicator and chassis intrusion pin.



**A. Front panel SMBus connecting pin (6-1 pin FPSMB)**

This header allows you to connect SMBus (System Management Bus) equipment. It can be used for communication between peripheral equipment in the system, which has slower transmission rates, and power management equipment.

**B. Internet status indicator (2-pin LAN1\_LED, LAN2\_LED)**

These two 2-pin headers allow you to use the Gigabit internet indicator cable to connect to the LAN status indicator. When this indicator flickers, it means that the internet is properly connected.

**C. Chassis intrusion pin (2-pin CHASSIS)**

This header is provided for host computer chassis with chassis intrusion detection designs. In addition, it must also work with external detection equipment, such as a chassis intrusion detection sensor or a microswitch. When this function is activated, if any chassis component movement occurs, the sensor will immediately detect it and send a signal to this header, and the system will then record this chassis intrusion event. The default setting is set to the CASEOPEN and GND pin; this function is off.

---

### Serial ATA3 Connectors

(SATA\_1)  
(see p.6, No. 18)  
(SATA\_2)  
(see p.6, No. 20)  
(SATA\_3)  
(see p.6, No. 19)  
(SATA\_4)  
(see p.6, No. 22)  
(SATA\_5)  
(see p.6, No. 21)  
(SATA\_6)  
(see p.6, No. 24)  
(SATA\_7)  
(see p.6, No. 23)

(M\_SATA\_0)  
(see p.6, No. 26)  
(M\_SATA\_1)  
(see p.6, No. 25)  
(M\_SATA\_2)  
(see p.6, No. 28)  
(M\_SATA\_3)  
(see p.6, No. 27)

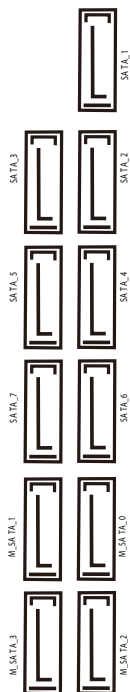

These SATA3 connectors support SATA data cables for internal storage devices with up to 6.0 Gb/s data transfer rate.

---

### Serial ATA3 DOM

Connector  
(SATA\_0)  
(see p.6, No. 17)



The SATA3 DOM connector supports both a SATA DOM (Disk-On-Module) and a SATA data cable for internal storage device.

---

### SATA Power Connectors

(4-pin SATA\_PWR1)  
(see p.6, No. 13)

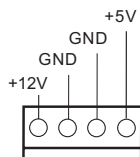

Please connect a SATA power cable.

USB 3.0 Header  
(19-pin USB3\_1\_2)  
(see p.6, No. 15)

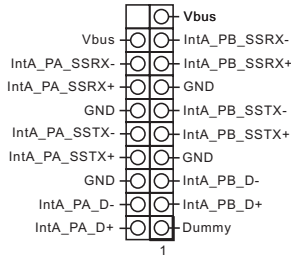

There is one USB 3.0 header on this motherboard. This USB 3.0 header can support two USB 3.0 ports.

USB 2.0 Headers  
(9-pin USB\_1\_2)  
(see p.6, No. 14)  
(9-pin USB\_3\_4)  
(see p.6, No. 31)  
(9-pin USB\_5\_6)  
(see p.6, No. 33)

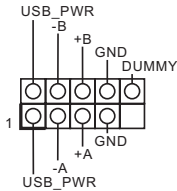

There are three USB 2.0 headers on this motherboard. Each USB 2.0 header can support two ports.

Chassis Speaker Header  
(4-pin SPEAKER1)  
(see p.6, No. 36)

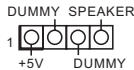

Please connect the chassis speaker to this header.

CPU Fan Connectors  
(4-pin CPU1\_FAN1)  
(see p.6, No. 6)

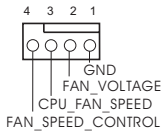

This motherboard provides one 4-Pin CPU fan (Quiet Fan) connectors. If you plan to connect a 3-Pin CPU fan, please connect it to Pin 1-3.

*\*For more details, please refer to the Cooler QVL list on the ASRock Rack website.*

Non Maskable Interrupt  
Button Header  
(2-pin NMI\_BTN1)  
(see p.6, No. 34)

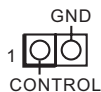

Please connect a NMI device to this header.

Front and Rear Fan Connectors

- (4-pin FRNT\_FAN1) (see p.6, No. 7)
- (4-pin FRNT\_FAN2) (see p.6, No. 8)
- (4-pin FRNT\_FAN3) (see p.6, No. 9)
- (4-pin FRNT\_FAN4) (see p.6, No. 10)
- (4-pin REAR\_FAN1) (see p.6, No. 1)

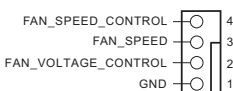
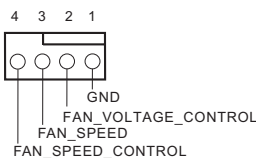

Please connect fan cables to the fan connectors and match the black wire to the ground pin. All fans support Fan Control.

ATX Power Connector (24-pin ATXPWR1) (see p.6, No. 3)

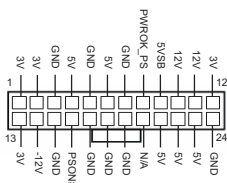

This motherboard provides a 24-pin ATX power connector. To use a 20-pin ATX power supply, please plug it along Pin 1 and Pin 13.

ATX 12V Power Connector (8-pin ATX12V1) (see p.6, No. 2)

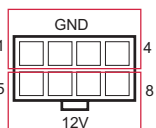

This motherboard provides two 8-pin ATX 12V power connectors.

TPM Header (17-pin TPM1) (see p.6, No. 32)

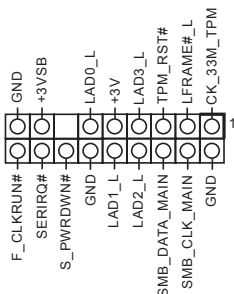

This connector supports Trusted Platform Module (TPM) system, which can securely store keys, digital certificates, passwords, and data. A TPM system also helps enhance network security, protects digital identities, and ensures platform integrity.

Serial General Purpose  
Input/Output Headers  
(7-pin SATA\_SGPIO1)  
(see p.6, No. 11)  
(7-pin SATA\_SGPIO2)  
(see p.6, No. 12)

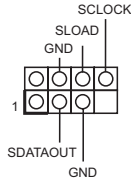

The headers support Serial Link interface for onboard SATA connections.

Thermal Sensor Header  
(3-pin TR1)  
(see p.6, No. 38)



Please connect the thermal sensor cable to either pin 1-2 or pin 2-3 and the other end to the device which you wish to monitor its temperature.

Front Panel Audio Header  
(9-pin HD\_AUDIO1)  
(see p.6, No. 39)

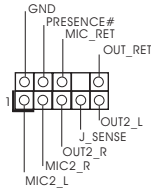

This header is for connecting audio devices to the front audio panel.



- High Definition Audio supports Jack Sensing, but the panel wire on the chassis must support HDA to function correctly. Please follow the instructions in our manual and chassis manual to install your system.
- If you use an AC'97 audio panel, please install it to the front panel audio header by the steps below:
  - Connect Mic\_IN (MIC) to MIC2\_L.
  - Connect Audio\_R (RIN) to OUT2\_R and Audio\_L (LIN) to OUT2\_L.
  - Connect Ground (GND) to Ground (GND).
  - MIC\_RET and OUT\_RET are for the HD audio panel only. You don't need to connect them for the AC'97 audio panel.
  - To activate the front mic, go to the "FrontMic" Tab in the Realtek Control panel and adjust "Recording Volume".

Clear CMOS Pad  
(CLRMO51)  
(see p.6, No. 43)



CLRMO51 allows you to clear the data in CMOS. To clear CMOS, take out the CMOS battery and short the Clear CMOS Pad.

## 2.9 Dr. Debug

Dr. Debug is used to provide code information, which makes troubleshooting even easier. Please see the diagrams below for reading the Dr. Debug codes.

Code	Description
0x10	PEI_CORE_STARTED
0x11	PEI_CAR_CPU_INIT
0x15	PEI_CAR_NB_INIT
0x19	PEI_CAR_SB_INIT
0x31	PEI_MEMORY_INSTALLED
0x32	PEI_CPU_INIT
0x33	PEI_CPU_CACHE_INIT
0x34	PEI_CPU_AP_INIT
0x35	PEI_CPU_BSP_SELECT
0x36	PEI_CPU_SMM_INIT
0x37	PEI_MEM_NB_INIT
0x3B	PEI_MEM_SB_INIT
0x4F	PEI_DXE_IPL_STARTED
0x60	DXE_CORE_STARTED
0x61	DXE_NVRAM_INIT
0x62	DXE_SBRUN_INIT



0x63	DXE_CPU_INIT
0x68	DXE_NB_HB_INIT
0x69	DXE_NB_INIT
0x6A	DXE_NB_SMM_INIT
0x70	DXE_SB_INIT
0x71	DXE_SB_SMM_INIT
0x72	DXE_SB_DEVICES_INIT
0x78	DXE_ACPI_INIT
0x79	DXE_CSM_INIT
0x90	DXE_BDS_STARTED
0x91	DXE_BDS_CONNECT_DRIVERS
0x92	DXE_PCI_BUS_BEGIN
0x93	DXE_PCI_BUS_HPC_INIT
0x94	DXE_PCI_BUS_ENUM
0x95	DXE_PCI_BUS_REQUEST_RESOURCES
0x96	DXE_PCI_BUS_ASSIGN_RESOURCES
0x97	DXE_CON_OUT_CONNECT
0x98	DXE_CON_IN_CONNECT

0x99	DXE_SIO_INIT
0x9A	DXE_USB_BEGIN
0x9B	DXE_USB_RESET
0x9C	DXE_USB_DETECT
0x9D	DXE_USB_ENABLE
0xA0	DXE_IDE_BEGIN
0xA1	DXE_IDE_RESET
0xA2	DXE_IDE_DETECT
0xA3	DXE_IDE_ENABLE
0xA4	DXE_SCSI_BEGIN
0xA5	DXE_SCSI_RESET
0xA6	DXE_SCSI_DETECT
0xA7	DXE_SCSI_ENABLE
0xA8	DXE_SETUP_VERIFYING_PASSWORD
0xA9	DXE_SETUP_START
0xAB	DXE_SETUP_INPUT_WAIT
0xAD	DXE_READY_TO_BOOT
0xAE	DXE_LEGACY_BOOT

0xAF	DXE_EXIT_BOOT_SERVICES
0xB0	RT_SET_VIRTUAL_ADDRESS_MAP_BEGIN
0xB1	RT_SET_VIRTUAL_ADDRESS_MAP_END
0xB2	DXE_LEGACY_OPROM_INIT
0xB3	DXE_RESET_SYSTEM
0xB4	DXE_USB_HOTPLUG
0xB5	DXE_PCI_BUS_HOTPLUG
0xB6	DXE_NVRAM_CLEANUP
0xB7	DXE_CONFIGURATION_RESET
0xF0	PEI_RECOVERY_AUTO
0xF1	PEI_RECOVERY_USER
0xF2	PEI_RECOVERY_STARTED
0xF3	PEI_RECOVERY_CAPSULE_FOUND
0xF4	PEI_RECOVERY_CAPSULE_LOADED
0xE0	PEI_S3_STARTED
0xE1	PEI_S3_BOOT_SCRIPT
0xE2	PEI_S3_VIDEO_REPOST

0xE3	PEI_S3_OS_WAKE
0x50	PEI_MEMORY_INVALID_TYPE
0x53	PEI_MEMORY_NOT_DETECTED
0x55	PEI_MEMORY_NOT_INSTALLED
0x57	PEI_CPU_MISMATCH
0x58	PEI_CPU_SELF_TEST_FAILED
0x59	PEI_CPU_NO_MICROCODE
0x5A	PEI_CPU_ERROR
0x5B	PEI_RESET_NOT_AVAILABLE
0xD0	DXE_CPU_ERROR
0xD1	DXE_NB_ERROR
0xD2	DXE_SB_ERROR
0xD3	DXE_ARCH_PROTOCOL_NOT_AVAILABLE
0xD4	DXE_PCI_BUS_OUT_OF_RESOURCES
0xD5	DXE_LEGACY_OPROM_NO_SPACE
0xD6	DXE_NO_CON_OUT
0xD7	DXE_NO_CON_IN

0xD8	DXE_INVALID_PASSWORD
0xD9	DXE_BOOT_OPTION_LOAD_ERROR
0xDA	DXE_BOOT_OPTION_FAILED
0xDB	DXE_FLASH_UPDATE_FAILED
0xDC	DXE_RESET_NOT_AVAILABLE
0xE8	PEI_MEMORY_S3_RESUME_FAILED
0xE9	PEI_S3_RESUME_PPI_NOT_FOUND
0xEA	PEI_S3_BOOT_SCRIPT_ERROR
0xEB	PEI_S3_OS_WAKE_ERROR

---

## 2.10 Driver Installation Guide

To install the drivers to your system, please insert the support CD to your optical drive first. Then, the drivers compatible to your system can be auto-detected and listed on the support CD driver page. Please follow the order from top to bottom to install those required drivers. Therefore, the drivers you install can work properly.

## 2.11 Dual LAN and Teaming Operation Guide

Dual LAN with Teaming enabled on this motherboard allows two single connections to act as one single connection(s) for twice the transmission bandwidth, making data transmission more effective and improving the quality of transmission of distant images. Fault tolerance on the dual LAN network prevents network downtime by transferring the workload from a failed port to a working port.



*The speed of transmission is subject to the actual network environment or status even with Teaming enabled.*

Before setting up Teaming, please make sure whether your Switch (or Router) supports Teaming (IEEE 802.3ad Link Aggregation). You can specify a preferred adapter in Intel PROSet. Under normal conditions, the Primary adapter handles all non-TCP/IP traffic. The Secondary adapter will receive fallback traffic if the primary fails. If the Preferred Primary adapter fails, but is later restored to an active status, control is automatically switched back to the Preferred Primary adapter.

### **Step 1**

From **Device Manager**, open the properties of a team.

### **Step 2**

Click the **Settings** tab.

### **Step 3**

Click the **Modify Team** button.

### **Step 4**

Select the adapter you want to be the primary adapter and click the **Set Primary** button.

If you do not specify a preferred primary adapter, the software will choose an adapter of the highest capability (model and speed) to act as the default primary. If a failover occurs, another adapter becomes the primary. The adapter will, however, rejoin the team as a non-primary.

## 2.12 M.2\_SSD (NGFF) Module Installation Guide (M2\_1 / M2\_2)

The M.2, also known as the Next Generation Form Factor (NGFF), is a small size and versatile card edge connector that aims to replace mPCIe and mSATA. The M.2 Socket (M2\_1) supports M.2 SATA3 6.0 Gb/s module and M.2 PCI Express module up to Gen3 x4 (32 Gb/s).

*\*The M.2 slot (M2\_2) is shared with the PCIE2 slot. When M2\_2 is populated with a M.2 PCI Express module, PCIE2 is disabled.*

### Installing the M.2\_SSD (NGFF) Module

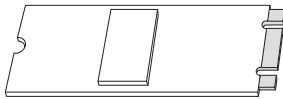

#### Step 1

Prepare a M.2\_SSD (NGFF) module and the screw.

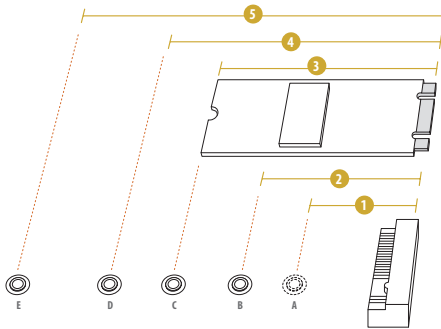

#### Step 2

Depending on the PCB type and length of your M.2\_SSD (NGFF) module, find the corresponding nut location to be used.

No.	1	2	3	4	5
Nut Location	A	B	C	D	E
PCB Length	3cm	4.2cm	6cm	8cm	11cm
Module Type	Type2230	Type 2242	Type2260	Type 2280	Type 22110

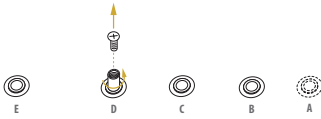

**Step 3**

Move the standoff based on the module type and length.

Skip Step 3 and 4 and go straight to Step 5 if you are going to use the default nut.

Otherwise, release the standoff by hand.

**Step 4**

Peel off the yellow protective film on the nut to be used. Hand tighten the standoff into the desired nut location on the motherboard.

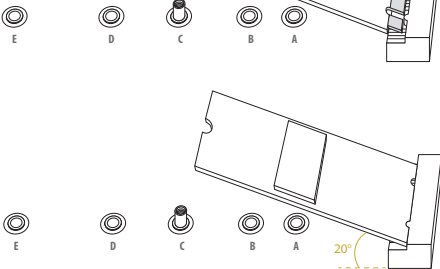
**Step 5**

Gently insert the M.2 (NGFF) SSD module into the M.2 slot. Please be aware that the M.2 (NGFF) SSD module only fits in one orientation.

### Step 6

Tighten the screw with a screwdriver to secure the module into place.  
Please do not overtighten the screw as this might damage the module.

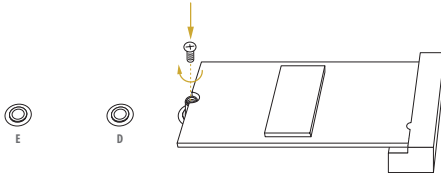

## 2.13 M.2 WiFi/BT Module Installation Guide (M2\_3)

The M.2, also known as the Next Generation Form Factor (NGFF), is a small size and versatile card edge connector that aims to replace mPCIe and mSATA. The M.2 Socket (Key E) supports type 2230 WiFi/BT module.

\* The M.2 socket does not support SATA M.2 SSDs.

### Installing the WiFi/BT module

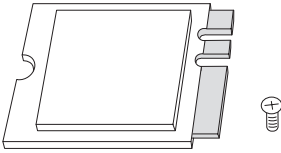

#### Step 1

Prepare a type 2230 WiFi/BT module or Intel® CNVi (Integrated WiFi/BT) and the screw.

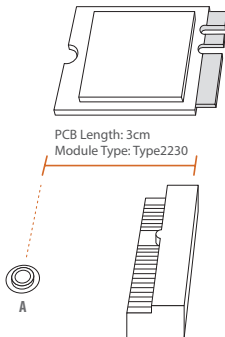

#### Step 2

Find the nut location to be used.

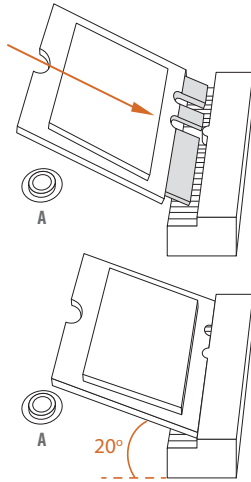

### **Step 3**

Gently insert the WiFi/BT module into the M.2 slot. Please be aware that the module only fits in one orientation.

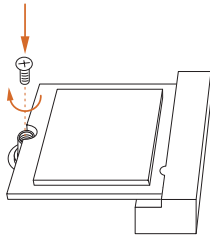

### **Step 4**

Tighten the screw with a screwdriver to secure the module into place. Please do not overtighten the screw as this might damage the module.

## Chapter 3 UEFI Setup Utility

### 3.1 Introduction

This section explains how to use the UEFI SETUP UTILITY to configure your system. The UEFI chip on the motherboard stores the UEFI SETUP UTILITY. You may run the UEFI SETUP UTILITY when you start up the computer. Please press <F2> or <Del> during the Power-On-Self-Test (POST) to enter the UEFI SETUP UTILITY; otherwise, POST will continue with its test routines.

If you wish to enter the UEFI SETUP UTILITY after POST, restart the system by pressing <Ctrl> + <Alt> + <Delete>, or by pressing the reset button on the system chassis. You may also restart by turning the system off and then back on.



*Because the UEFI software is constantly being updated, the following UEFI setup screens and descriptions are for reference purpose only, and they may not exactly match what you see on your screen.*

#### 3.1.1 UEFI Menu Bar

The top of the screen has a menu bar with the following selections:

Item	Description
Main	To set up the system time/date information
Advanced	To set up the advanced UEFI features
Boot	To set up the default system device to locate and load the Operating System
Security	To set up the security features
Event Logs	For event log configuration
Exit	To exit the current screen or the UEFI SETUP UTILITY

Use <←→> key or <→> key to choose among the selections on the menu bar, and then press <Enter> to get into the sub screen.

### 3.1.2 Navigation Keys

Please check the following table for the function description of each navigation key.

Navigation Key(s)	Function Description
← / →	Moves cursor left or right to select Screens
↑ / ↓	Moves cursor up or down to select items
+ / -	To change option for the selected items
<Tab>	Switch to next function
<Enter>	To bring up the selected screen
<PGUP>	Go to the previous page
<PGDN>	Go to the next page
<HOME>	Go to the top of the screen
<END>	Go to the bottom of the screen
<F1>	To display the General Help Screen
<F7>	Discard changes and exit the UEFI SETUP UTILITY
<F9>	Load optimal default values for all the settings
<F10>	Save changes and exit the UEFI SETUP UTILITY
<F12>	Print screen
<ESC>	Jump to the Exit Screen or exit the current screen

## 3.2 Main Screen

Once you enter the UEFI SETUP UTILITY, the Main screen will appear and display the system overview. The Main screen provides system overview information and allows you to set the system time and date.

```

Aptio Setup Utility - Copyright (C) 2019 American Megatrends, Inc.
Main Advanced Security Boot Event Logs Exit

UEFI Version      : C246 WS L1.02
Processor Type    : Genuine Intel(R) CPU 0000 @ 3.10GHz
Processor Speed   : 3100MHz
Microcode Update  : 906EC/00000084
PCH               : C246 - B0

L1 Data Cache Size : 32KB
L1 Instruction Cache Size : 32KB x 8
L2 Cache Size      : 256KB x 8
L3 Cache Size      : 16MB

Total Memory      : 4GB,      Single-Channel Memory Mode
DDR4_A1           : None
DDR4_A2           : 4GB ECC-DIMM (DDR4-2133)
DDR4_B1           : None
DDR4_B2           : None

System Date       : [Tue 01/15/2019]
System Time       : [17:43:20]

Set the Date. Use Tab to
switch between Date elements.
Default Ranges:
Year: 2005-2099
Months: 1-12
Days: dependent on month

+/-: Change Option
F1: General Help
F7: Discard Changes
F9: Load UEFI Defaults
F10: Save and Exit
ESC: Exit

Version 2.20.1271. Copyright (C) 2019 American Megatrends, Inc. 34

```

### 3.3 Advanced Screen

In this section, you may set the configurations for the following items: CPU Configuration, DRAM Configuration, Chipset Configuration, Storage Configuration, ACPI Configuration, USB Configuration, Super IO Configuration, Serial Port Console Redirection, H/W Monitor, Runtime Error Logging, Server ME Configuration, Intel(R) Bios Guard Technology and Instant Flash.

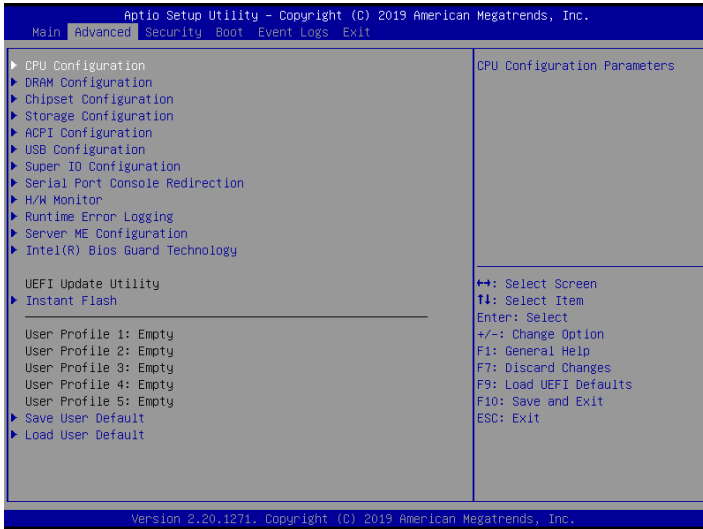

#### Save User Default

Type a profile name and press enter to save your settings as user default.

#### Load User Default

Load previously saved user defaults.



*Setting wrong values in this section may cause the system to malfunction.*



### 3.3.1 CPU Configuration

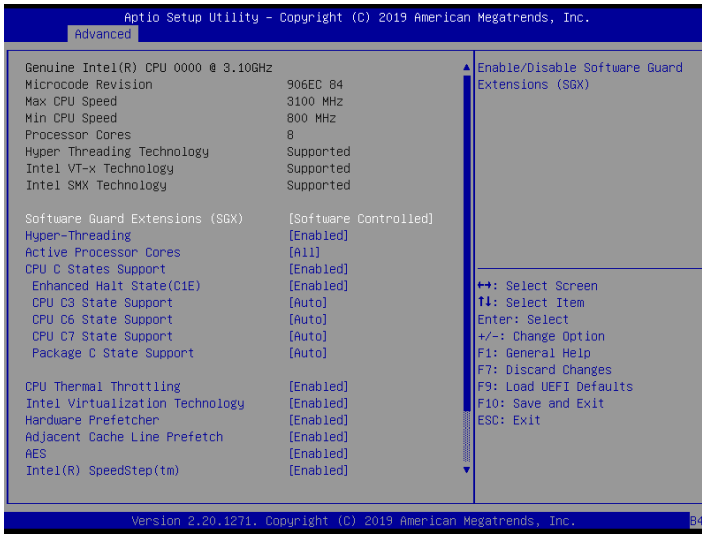

#### Software Guard Extensions (SGX)

Use this item to enable or disable Software Controlled Software Guard Extensions (SGX).

#### Hyper Threading

Intel Hyper Threading Technology allows multiple threads to run on each core, so that the overall performance on threaded software is improved.

#### Active Processor Cores

Select the number of cores to enable in each processor package.

#### CPU C States Support

Enable CPU C States Support for power saving. It is recommended to keep C3, C6 and C7 all enabled for better power saving.

#### Enhanced Halt State (C1E)

Enable Enhanced Halt State (C1E) for lower power consumption.

#### CPU C3 State Support

Enable C3 sleep state for lower power consumption.

#### CPU C6 State Support

Enable C6 deep sleep state for lower power consumption.

## CPU C7 State Support

Enable C7 deep sleep state for lower power consumption.

## Package C State Support

Enable CPU, PCIe, Memory, Graphics C State Support for power saving.

## CPU Thermal Throttling

Enable CPU internal thermal control mechanisms to keep the CPU from overheating.

## Intel Virtualization Technology

Intel Virtualization Technology allows a platform to run multiple operating systems and applications in independent partitions, so that one computer system can function as multiple virtual systems.

## Hardware Prefetcher

Automatically prefetch data and code for the processor. Enable for better performance.

## Adjacent Cache Line Prefetch

Automatically prefetch the subsequent cache line while retrieving the currently requested cache line. Enable for better performance.

## AES

Use this to enable or disable CPU Advanced Encryption Standard instructions.

## Intel(R) SpeedStep(tm)

Intel SpeedStep technology is Intel's new power saving technology. Processors can switch between multiple frequencies and voltage points to enable power saving. The default value is [Enabled]. Configuration options: [Enabled] and [Disabled]. This item will be hidden if the current CPU does not support Intel SpeedStep technology.



*Please note that enabling this function may reduce CPU voltage and lead to system stability or compatibility issues with some power supplies. Please set this item to [Disabled] if above issues occur.*

## Turbo Mode

Use this item to enable or disable Intel Turbo Boost Mode Technology. Turbo Boost Mode allows processor cores to run faster than marked frequency in specific conditions. The default value is [Enabled].

## Enable Intel TXT Support

Use this to enable or disable Intel Trusted Execution Technology.

## Long Duration Power Limit

Configure Package Power Limit 1 in watts. When the limit is exceeded, the CPU ratio will be lowered after a period of time. A lower limit can protect the CPU and save power, while a higher limit may improve performance.

## Long Duration Maintained

Configure the period of time until the CPU ratio is lowered when the Long Duration Power Limit is exceeded.

## Short Duration Power Limit

Configure Package Power Limit 2 in watts. When the limit is exceeded, the CPU ratio will be lowered immediately. A lower limit can protect the CPU and save power, while a higher limit may improve performance.

### 3.3.2 DRAM Configuration

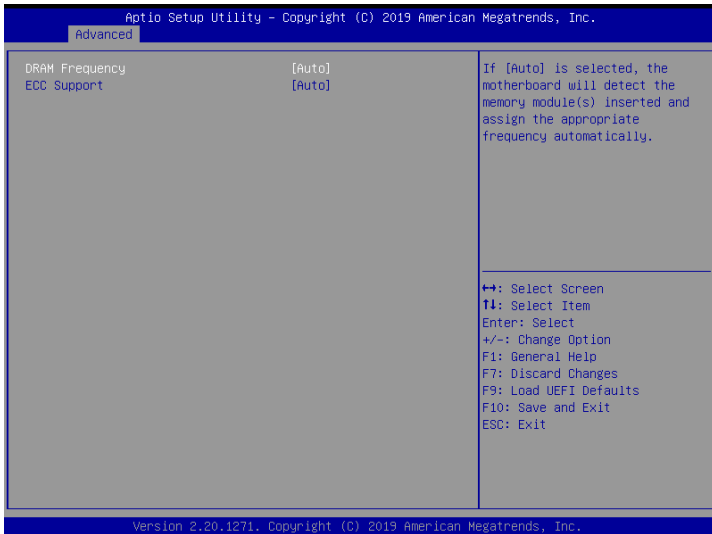

#### DRAM Frequency

If [Auto] is selected, the motherboard will detect the memory module(s) inserted and assign the appropriate frequency automatically.

#### ECC Support

Use this item to enable or disable DDR ECC Support.

### 3.3.3 Chipset Configuration

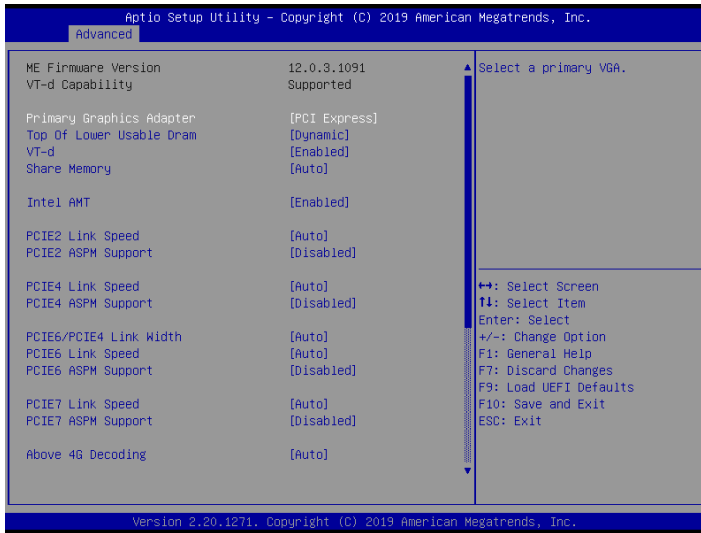

#### Primary Graphics Adapter

If PCI Express graphics card is installed on the motherboard, you may use this option to select PCI Express or Onboard as the primary graphics adapter.

#### Top of Lower Usable Dram

Maximum Value of TOLUD. Dynamic assignment would adjust TOLUD automatically based on largest MMIO length of installed graphic controller.

#### VT-d

Intel Virtualization Technology for Directed I/O helps your virtual machine monitor better utilize hardware by improving application compatibility and reliability, and providing additional levels of manageability, security, isolation, and I/O performance.

#### Share Memory

Configure the size of memory that is allocated to the integrated graphics processor when the system boots up.

#### Intel AMT

Use this option to enable or disable Intel(R) Active Management Technology BIOS Extension. Please be noted that the iAMT H/W is always enabled. This option just controls the BIOS extension execution. If enabled, this requires additional firmware in the SPI device.

### PCIE2 Link Speed

This allows you to select PCIE2 Link Speed. The default value is [Auto].

### PCIE2 ASPM Support

This option enables or disables the ASPM support for PCIE2.

### PCIE4 Link Speed

This allows you to select PCIE4 Link Speed. The default value is [Auto].

### PCIE4 ASPM Support

This option enables or disables the ASPM support for PCIE4.

### PCIE6/PCIE4 Link Width

This allows you to select PCIE6/PCIE4 Link Width. The default value is [Auto].

### PCIE6 Link Speed

This allows you to select PCIE6 Link Speed. The default value is [Auto].

### PCIE6 ASPM Support

This option enables or disables the ASPM support for PCIE6.

### PCIE7 Link Speed

This allows you to select PCIE7 Link Speed. The default value is [Auto].

### PCIE7 ASPM Support

This option enables or disables the ASPM support for PCIE7.

### Above 4G Decoding

Enable or disable 64bit capable Devices to be decoded in Above 4G Address Space (only if the system supports 64 bit PCI decoding).

### IGPU Multi-Monitor

Select disable to disable the integrated graphics when an external graphics card is installed. Select enable to keep the integrated graphics enabled at all times.

### Onboard HDMI HD Audio

This allows you to enable or disable the Onboard HDMI HD Audio feature.

### M.2 WIFI

This allows you to enable or disable M.2 WIFI.

## Onboard LAN1 (I210)

Use this to enable or disable the Onboard LAN1 function. The default value is [Enabled].

## Onboard LAN2 (I219)

Use this to enable or disable the Onboard LAN2 function. The default value is [Enabled].

## SR-IOV Support

If system has SR-IOV capable PCIe Devices, this option Enables or Disables Single Root IO Virtualization Support.

## Onboard HD Audio

Enable/disable onboard HD audio. Set to Auto to enable onboard HD audio and automatically disable it when a sound card is installed.

## Front Panel

Enable/disable front panel HD audio.

## Restore AC Power Loss

This allows you to set the power state after an unexpected AC/power loss. If [Power Off] is selected, the AC/power remains off when the power recovers. If [Power On] is selected, the AC/power resumes and the system starts to boot up when the power recovers. If [Last State] is selected, it will recover to the state before AC/power loss.

## Onboard Debug Port LED

Enable/Disable the onboard Dr. Debug LED.

## 3.3.4 Storage Configuration

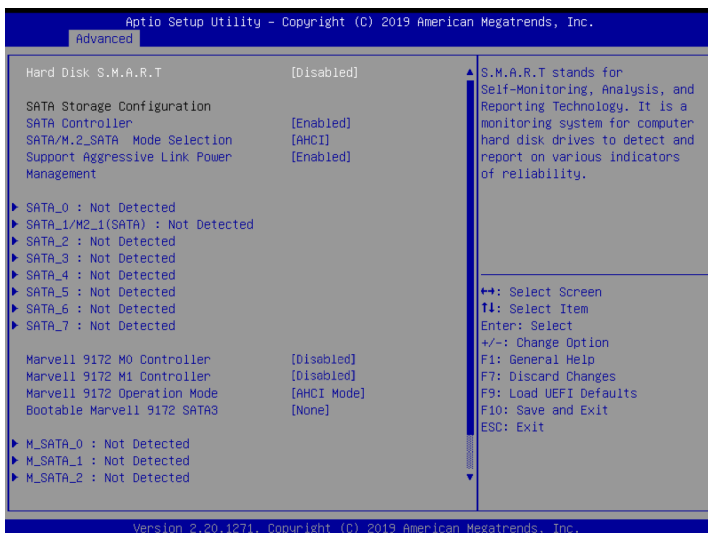

### SATA Controller(s)

Use this item to enable or disable the SATA controllers.

### SATA/M.2\_SATA Mode Selection

Identify the SATA port is connected to Solid State Drive or Hard Disk Drive. Press <Ctrl+I> to enter RAID ROM during UEFI POST process.

### SATA Aggressive Link Power Management

SATA Aggressive Link Power Management allows SATA devices to enter a low power state during periods of inactivity to save power. It is only supported by AHCI mode.

### Marvell 9172 M0 Controller

Enable or disable Marvell 9172 Controller.

*\*In RedHat Enterprise Linux Server 7.4 (64 bit), please disable the Marvell 9172 controller in the BIOS.*

### Marvell 9172 M1 Controller

Enable or disable Marvell 9172 Controller.

*\*In RedHat Enterprise Linux Server 7.4 (64 bit), please disable the Marvell 9172 controller in the BIOS.*

### Marvell 9172 Operation Mode

This item is for M\_SATA ports. Use this to select Marvell SATA operation mode.



Configuration options: [IDE Mode], [AHCI Mode] and [RAID Mode]. The default value is [AHCI Mode]. Press <Ctrl-M> to enter RAID ROM during UEFI POST process.

### **Bootable Marvell 9172 SATA3**

We recommend to use Intel SATA ports (Port 0~5) for your bootable devices. This will minimize your boot time and get the best performance. If you still want to boot from Marvell SATA3 controller, please set this item to [Yes].

### 3.3.5 ACPI Configuration

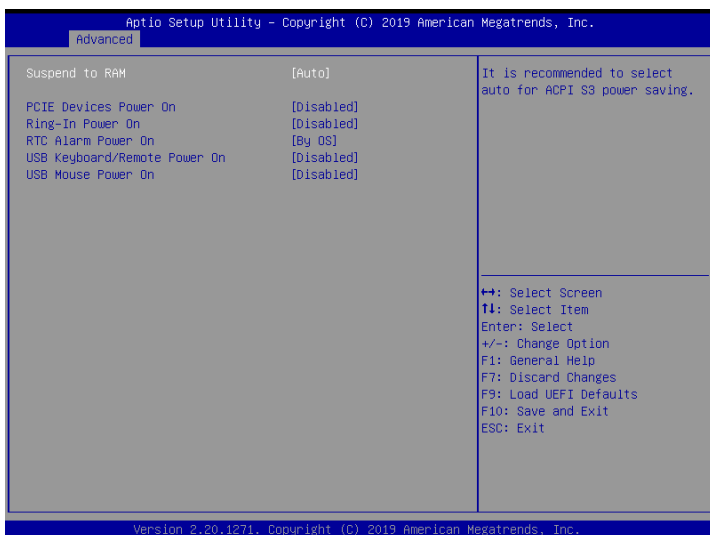

#### Suspend to RAM

Select disable for ACPI suspend type S1. It is recommended to select auto for ACPI S3 power saving.

#### PCIE Devices Power On

Use this item to enable or disable PCIE devices to turn on the system from the power-soft-off mode.

#### Ring-In Power On

Use this item to enable or disable Ring-In signals to turn on the system from the power-soft-off mode.

#### RTC Alarm Power On

Use this item to enable or disable RTC (Real Time Clock) to power on the system.

#### USB Keyboard/Remote Power On

Allow the system to be waked up by a USB keyboard or remote controller.

#### USB Mouse Power On

Allow the system to be waked up by a USB mouse.

### 3.3.6 USB Configuration



#### Legacy USB Support

Enable Legacy OS Support for USB 2.0 devices. Select UEFI Setup Only to support USB devices under the UEFI setup and Windows/Linux operating systems only.

### 3.3.7 Super IO Configuration



#### Serial Port

Use this item to enable or disable the onboard serial port.

#### Serial Port Address

Use this item to select an optimal setting for Super IO device.

### 3.3.8 Serial Port Console Redirection

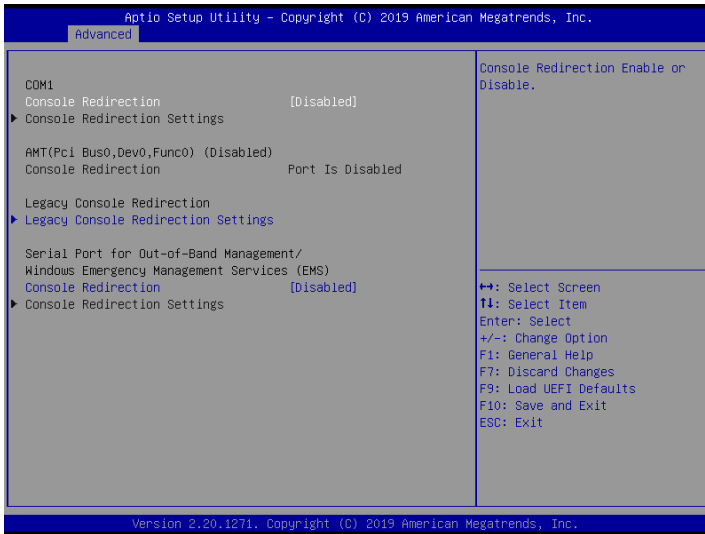

#### COM1

#### Console Redirection

Use this option to enable or disable Console Redirection. If this item is set to Enabled, you can select a COM Port to be used for Console Redirection.

#### Console Redirection Settings

Use this option to configure Console Redirection Settings, and specify how your computer and the host computer to which you are connected exchange information.

#### Terminal Type

Use this item to select the preferred terminal emulation type for out-of-band management. It is recommended to select [VT-UTF8].

Option	Description
VT100	ASCII character set
VT100+	Extended VT100 that supports color and function keys
VT-UTF8	UTF8 encoding is used to map Unicode chars onto 1 or more bytes
ANSI	Extended ASCII character set

### **Bits Per Second**

Use this item to select the serial port transmission speed. The speed used in the host computer and the client computer must be the same. Long or noisy lines may require lower transmission speed. The options include [9600], [19200], [57600] and [115200].

### **Data Bits**

Use this item to set the data transmission size. The options include [7] and [8] (Bits).

### **Parity**

Use this item to select the parity bit. The options include [None], [Even], [Odd], [Mark] and [Space].

### **Stop Bits**

The item indicates the end of a serial data packet. The standard setting is [1] Stop Bit. Select [2] Stop Bits for slower devices.

### **Flow Control**

Use this item to set the flow control to prevent data loss from buffer overflow. When sending data, if the receiving buffers are full, a "stop" signal can be sent to stop the data flow. Once the buffers are empty, a "start" signal can be sent to restart the flow. Hardware flow uses two wires to send start/stop signals. The options include [None] and [Hardware RTS/CTS].

### **VT-UTF8 Combo Key Support**

Use this item to enable or disable the VT-UTF8 Combo Key Support for ANSI/VT100 terminals.

### **Recorder Mode**

Use this item to enable or disable Recorder Mode to capture terminal data and send it as text messages.

### **Resolution 100x31**

Use this item to enable or disable extended terminal resolution support.

### **Putty Keypad**

Use this item to select Function Key and Keypad on Putty.

## **Legacy Console Redirection**

### **Legacy Console Redirection Settings**

Use this option to configure Legacy Console Redirection Settings, and specify how your computer and the host computer to which you are connected exchange information.

### **Redirection COM Port**

Select a COM port to display redirection of Legacy OS and Legacy OPROM Messages.

### **Resolution**

On Legacy OS, the Number of Rows and Columns supported redirection.

## Redirect After POST

When Bootloader is selected, then Legacy Console Redirection is disabled before booting to legacy OS. When Always Enable is selected, then Legacy Console Redirection is enabled for legacy OS. Default setting for this option is set to Always Enable.

## Serial Port for Out-of-Band Management/Windows Emergency Management Services (EMS)

### Console Redirection

Use this option to enable or disable Console Redirection. If this item is set to Enabled, you can select a COM Port to be used for Console Redirection.

### Console Redirection Settings

Use this option to configure Console Redirection Settings, and specify how your computer and the host computer to which you are connected exchange information.

### Terminal Type

Use this item to select the preferred terminal emulation type for out-of-band management. It is recommended to select [VT-UTF8].

Option	Description
VT100	ASCII character set
VT100+	Extended VT100 that supports color and function keys
VT-UTF8	UTF8 encoding is used to map Unicode chars onto 1 or more bytes
ANSI	Extended ASCII character set

### Bits Per Second

Use this item to select the serial port transmission speed. The speed used in the host computer and the client computer must be the same. Long or noisy lines may require lower transmission speed. The options include [9600], [19200], [57600] and [115200].

### Flow Control

Use this item to set the flow control to prevent data loss from buffer overflow. When sending data, if the receiving buffers are full, a "stop" signal can be sent to stop the data flow. Once the buffers are empty, a "start" signal can be sent to restart the flow. Hardware flow uses two wires to send start/stop signals. The options include [None], [Hardware RTS/CTS], and [Software Xon/Xoff].

### Data Bits

### Parity

### Stop Bits

### 3.3.9 H/W Monitor

In this section, it allows you to monitor the status of the hardware on your system, including the parameters of the CPU temperature, motherboard temperature, CPU fan speed, chassis fan speed, and the critical voltage.

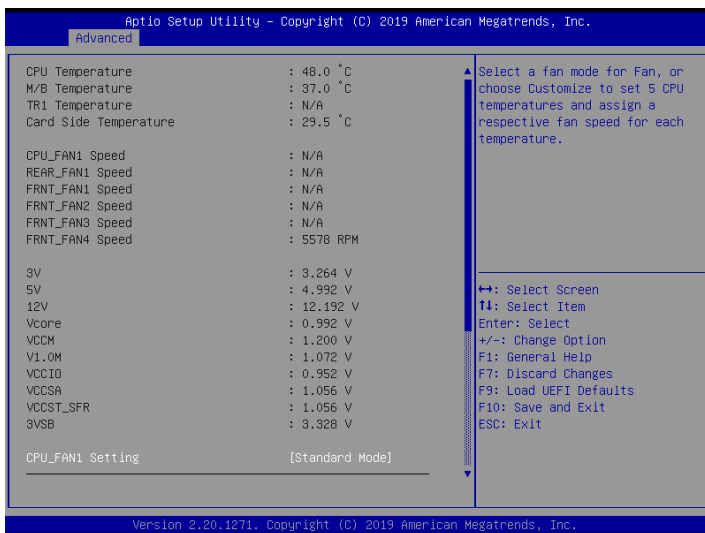

#### FAN Control

If [Auto] is selected, the fan speed will controlled by BMC.

If [Manual] is selected, configure the items below.

#### CPU\_FAN1 Setting

This allows you to set the CPU fan1's speed. The default value is [Smart Fan].

#### REAR\_FAN1 Setting

This allows you to set the rear fan 1's speed. The default value is [Smart Fan].

#### FRNT\_FAN1 Setting

This allows you to set the front fan 1's speed. The default value is [Smart Fan].

#### FRNT\_FAN2 Setting

This allows you to set the front fan 2's speed. The default value is [Smart Fan].

#### FRNT\_FAN3 Setting

This allows you to set the front fan 3's speed. The default value is [Smart Fan].



## FRNT\_FAN4 Setting

This allows you to set the front fan 4's speed. The default value is [Smart Fan].

### **Smart Fan Control**

This allows you to set the Smart fan's level speed.

### **Smart Fan Duty Control**

Smart Fan Duty x (x means 1 to 11 stage)

This allows you to set duty cycle for each stage.

### **Smart Fan Temp Control**

Smart Fan Temp x (x means 1 to 11 stage)

This allows you to set temperature for each stage.

## Watch Dog Timer

This allows you to enable or disable the Watch Dog Timer. The default value is [Disabled]

## Case Open Feature

Enable or disable Case Open Feature to detect whether the chassis cover has been removed.

## Clear Status

Enable to clear case open status if case open had been detected.

### 3.3.10 Runtime Error Logging

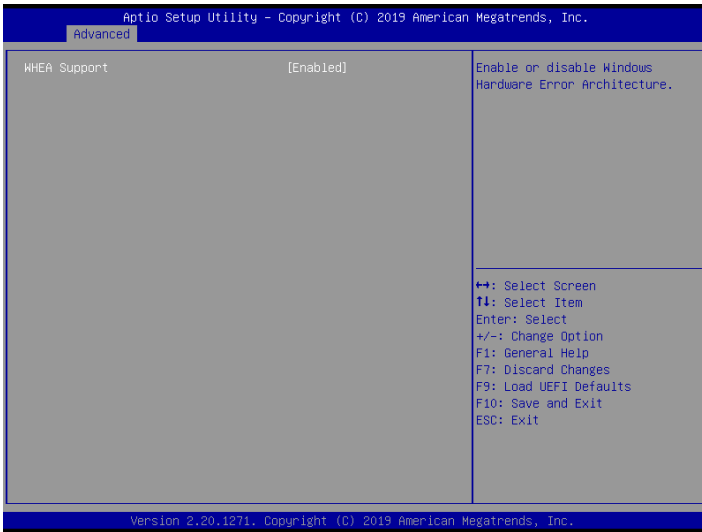

#### WHEA Support

Use this item to enable or disable Windows Hardware Error Architecture.

### 3.3.11 Intel ME Configuration



Intel ME Configuration screen displays the Intel ME Configuration information, such as Operational Firmware Version and Firmware State.

### 3.3.12 Intel(R) Bios Guard Technology

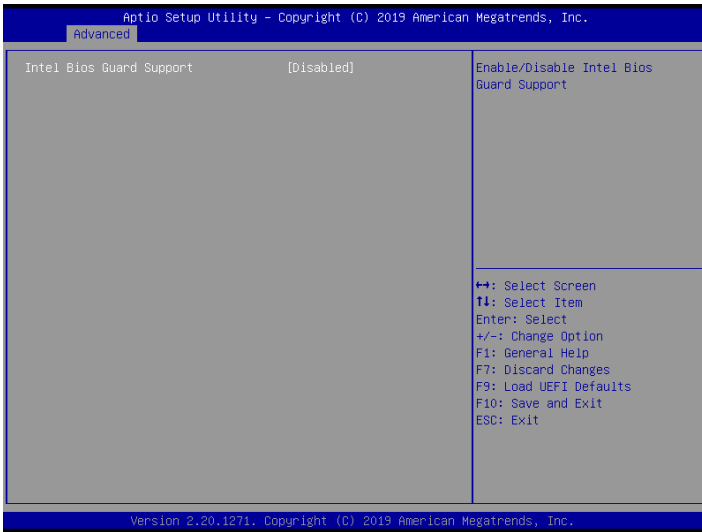

#### Intel Bios Guard Support

Use this to enable or disable Intel Bios Guard Support. The default value is [Disabled].

### 3.3.13 Instant Flash

Instant Flash is a UEFI flash utility embedded in Flash ROM. This convenient UEFI update tool allows you to update system UEFI without entering operating systems first like MS-DOS or Windows<sup>®</sup>. Just save the new UEFI file to your USB flash drive, floppy disk or hard drive and launch this tool, then you can update your UEFI only in a few clicks without preparing an additional floppy diskette or other complicated flash utility. Please be noted that the USB flash drive or hard drive must use FAT32/16/12 file system. If you execute Instant Flash utility, the utility will show the UEFI files and their respective information. Select the proper UEFI file to update your UEFI, and reboot your system after the UEFI update process is completed.

## 3.4 Security

In this section, you may set or change the supervisor/user password for the system. For the user password, you may also clear it.

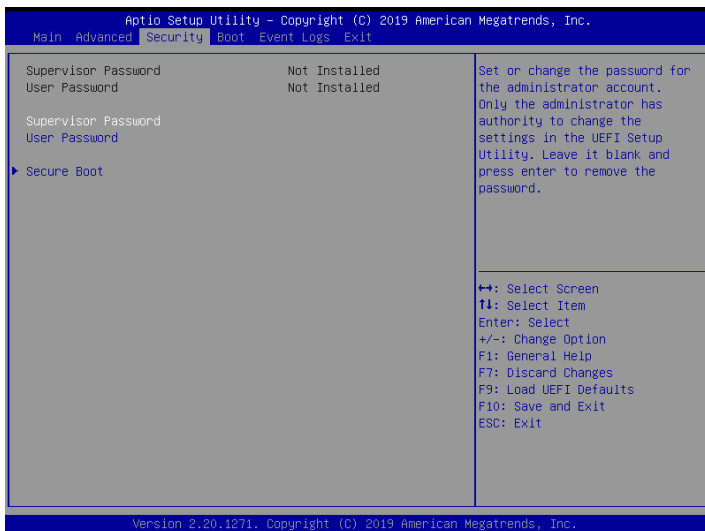

### Supervisor Password

Set or change the password for the administrator account. Only the administrator has authority to change the settings in the UEFI Setup Utility. Leave it blank and press enter to remove the password.

### User Password

Set or change the password for the user account. Users are unable to change the settings in the UEFI Setup Utility. Leave it blank and press enter to remove the password.

### Secure Boot

Use this to enable or disable Secure Boot Control. The default value is [Disabled]. Enable to support Windows Server 2012 R2 or later versions Secure Boot.

### Secure Boot Mode

Secure Boot mode options: Standard or Custom. In Custom mode, Secure Boot Policy variables can be configured by a physically present user without full authentication.

## 3.4.1 Key Management

In this section, expert users can modify Secure Boot Policy variables without full authentication.

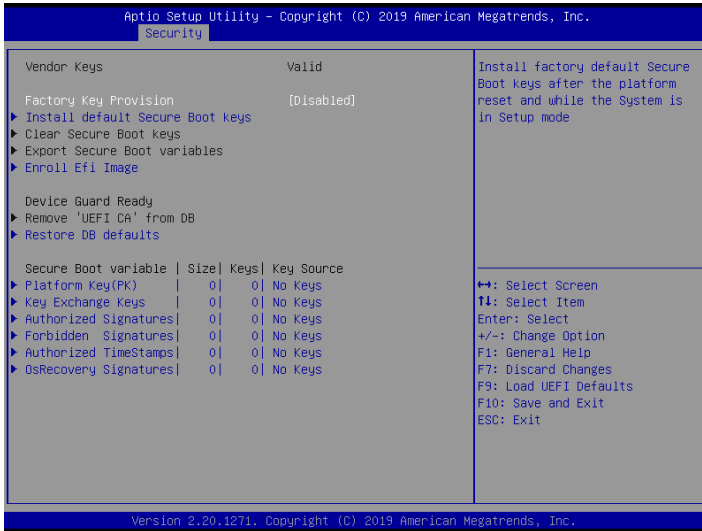

### Factory Key Provision

Install factory default Secure Boot keys after the platform reset and while the System is in Setup mode.

### Install Default Secure Boot Keys

Please install default secure boot keys if it's the first time you use secure boot.

### Enroll Efi Image

Allow the image to run in Secure Boot mode. Enroll SHA256 Hash certificate of a PE image into Authorized Signature Database (db).

### Restore DB Defaults

Restore DB variable to factory defaults.

### Platform Key(PK)

Enroll Factory Defaults or load certificates from a file:

1. Public Key Certificate in:

- a) EFI\_SIGNATURE\_LIST
- b) EFI\_CERT\_X509 (DER)
- c) EFI\_CERT\_RSA2048 (bin)
- d) EFI\_CERT\_SHA256, 384, 512

- 2. Authenticated UEFI Variable
- 3. EFI PE/COFF Image(SHA256)

Key Source: Factory, External, Mixed

### Key Exchange Keys

Enroll Factory Defaults or load certificates from a file:

- 1. Public Key Certificate in:
  - a) EFI\_SIGNATURE\_LIST
  - b) EFI\_CERT\_X509 (DER encoded)
  - c) EFI\_CERT\_RSA2048 (bin)
  - d) EFI\_CERT\_SHA256, 384, 512

- 2. Authenticated UEFI Variable
- 3. EFI PE/COFF Image(SHA256)

Key Source: Factory, External, Mixed

### Authorized Signatures

Enroll Factory Defaults or load certificates from a file:

- 1. Public Key Certificate in:
  - a) EFI\_SIGNATURE\_LIST
  - b) EFI\_CERT\_X509 (DER encoded)
  - c) EFI\_CERT\_RSA2048 (bin)
  - d) EFI\_CERT\_SHA256, 384, 512

- 2. Authenticated UEFI Variable
- 3. EFI PE/COFF Image(SHA256)

Key Source: Factory, External, Mixed



## Forbidden Signatures

Enroll Factory Defaults or load certificates from a file:

1. Public Key Certificate in:

- a) EFI\_SIGNATURE\_LIST
- b) EFI\_CERT\_X509 (DER encoded)
- c) EFI\_CERT\_RSA2048 (bin)
- d) EFI\_CERT\_SHA256, 384, 512

2. Authenticated UEFI Variable

3. EFI PE/COFF Image(SHA256)

Key Source: Factory, External, Mixed

## Authorized TimeStamps

Enroll Factory Defaults or load certificates from a file:

1. Public Key Certificate in:

- a) EFI\_SIGNATURE\_LIST
- b) EFI\_CERT\_X509 (DER encoded)
- c) EFI\_CERT\_RSA2048 (bin)
- d) EFI\_CERT\_SHA256, 384, 512

2. Authenticated UEFI Variable

3. EFI PE/COFF Image(SHA256)

Key Source: Factory, External, Mixed

## OsRecovery Signatures

Enroll Factory Defaults or load certificates from a file:

1. Public Key Certificate in:

- a) EFI\_SIGNATURE\_LIST
- b) EFI\_CERT\_X509 (DER encoded)
- c) EFI\_CERT\_RSA2048 (bin)
- d) EFI\_CERT\_SHA256, 384, 512

---

2. Authenticated UEFI Variable

3. EFI PE/COFF Image(SHA256)

Key Source: Default, External, Mixed, Test

## 3.5 Boot Screen

In this section, it will display the available devices on your system for you to configure the boot settings and the boot priority.

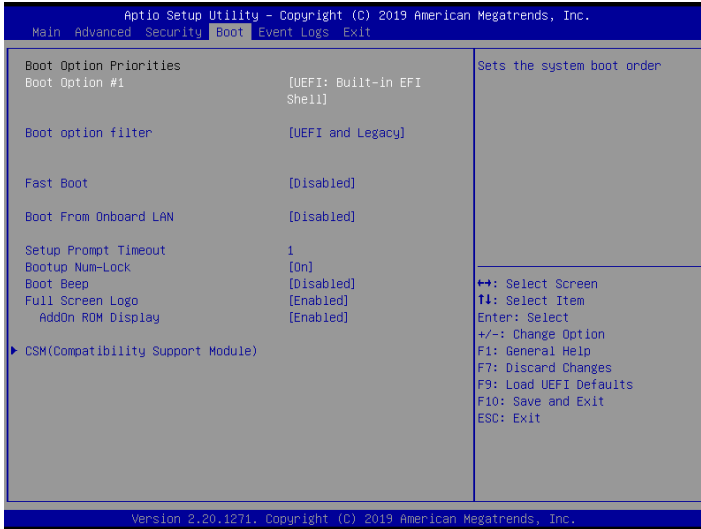

### Boot Option #1

Use this item to set the system boot order.

### Boot Option Filter

This option controls Legacy/UEFI ROMs priority.

### Fast Boot

Fast Boot minimizes your computer's boot time. In fast mode you may not boot from an USB storage device. Ultra Fast mode is only supported by Windows and the VBIOS must support UEFI GOP if you are using an external graphics card. Please notice that Ultra Fast mode will boot so fast that the only way to enter this UEFI Setup Utility is to Clear CMOS or run the Restart to UEFI utility in Windows.

### Boot From Onboard LAN

Use this item to enable or disable the Boot From Onboard LAN feature.

### Setup Prompt Timeout

Configure the number of seconds to wait for the UEFI setup utility.

## Bootup Num-Lock

If this item is set to [On], it will automatically activate the Numeric Lock function after boot-up.

## Boot Beep

Select whether the Boot Beep should be turned on or off when the system boots up. Please note that a buzzer is needed.

## Full Screen Logo

Use this item to enable or disable OEM Logo. The default value is [Enabled].

## AddOn ROM Display

Use this option to adjust AddOn ROM Display. If you enable the option “Full Screen Logo” but you want to see the AddOn ROM information when the system boots, please select [Enabled]. Configuration options: [Enabled] and [Disabled]. The default value is [Enabled].

## 3.5.1 CSM Parameters

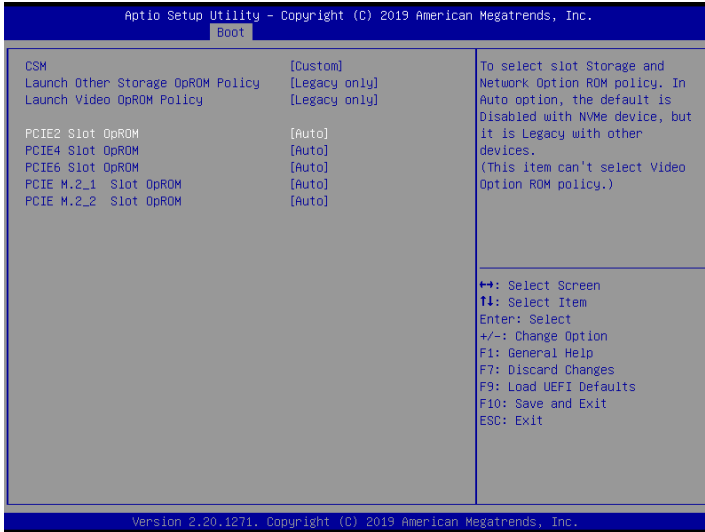

### CSM

Enable to launch the Compatibility Support Module. Please do not disable unless you're running a WHCK test. If you are using Windows Server 2012 R2 or later versions 64-bit UEFI and all of your devices support UEFI, you may also disable CSM for faster boot speed.

### Launch Other Storage OpROM Policy

Select UEFI only to run those that support UEFI option ROM only. Select Legacy only to run those that support legacy option ROM only. Select Do not launch to not execute both legacy and UEFI option ROM.

### Launch Video OpROM Policy

Select UEFI only to run those that support UEFI option ROM only. Select Legacy only to run those that support legacy option ROM only. Select Do not launch to not execute both legacy and UEFI option ROM.

### PCIe2 Slot OpROM

To select Slot Storage and Network Option ROM policy. In Auto option, the default is Disabled with NVMe device, but it is Legacy with other devices. (This item can't select Video Option ROM policy.)

## PCIE4 Slot OpROM

To select Slot Storage and Network Option ROM policy. In Auto option, the default is Disabled with NVMe device, but it is Legacy with other devices. (This item can't select Video Option ROM policy.)

## PCIE6 Slot OpROM

To select Slot Storage and Network Option ROM policy. In Auto option, the default is Disabled with NVMe device, but it is Legacy with other devices. (This item can't select Video Option ROM policy.)

## M.2\_1 Slot OpROM

To select Slot Storage and Network Option ROM policy. In Auto option, the default is Disabled with NVMe device, but it is Legacy with other devices. (This item can't select Video Option ROM policy.)

## M.2\_2 Slot OpROM

To select Slot Storage and Network Option ROM policy. In Auto option, the default is Disabled with NVMe device, but it is Legacy with other devices. (This item can't select Video Option ROM policy.)

## 3.6 Event Logs

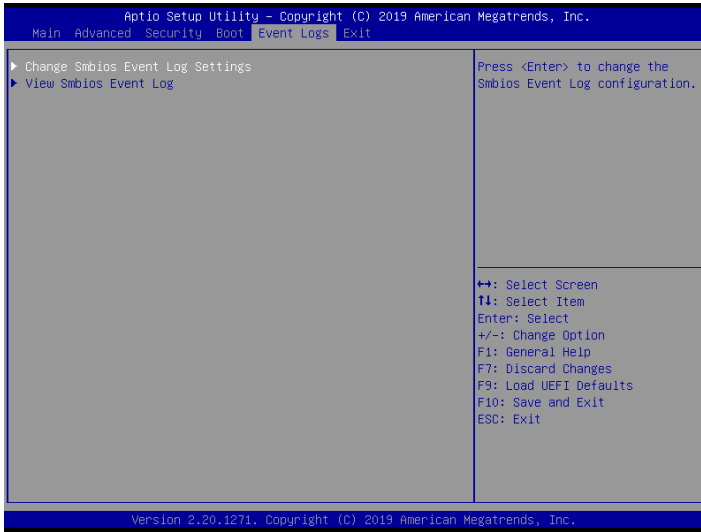

### Change Smbios Event Log Settings

This allows you to configure the Smbios Event Log Settings.

When entering the item, you will see the followings:

#### **Smbios Event Log**

Use this item to enable or disable all features of the SMBIOS Event Logging during system boot.

#### **Erase Event Log**

The options include [No], [Yes, Next reset] and [Yes, Every reset]. If Yes is selected, all logged events will be erased.

#### **When Log is Full**

Use this item to choose options for reactions to a full Smbios Event Log. The options include [Do Nothing] and [Erase Immediately].

#### **Log System Boot Event**

Choose option to enable/disable logging of System boot event.

#### **MECI (Multiple Event Count Increment)**

Use this item to enter the increment value for the multiple event counter. The valid range is from 1 to 255.

#### **METW (Multiple Event Time Window)**

Use this item to specify the number of minutes which must pass between duplicate log

entries which utilize a multiple-event counter. The value ranges from 0 to 99 minutes.

### View Smbios Event Log

Press <Enter> to view the Smbios Event Log records.



*All values changed here do not take effect until computer is restarted.*



## 3.7 Exit Screen

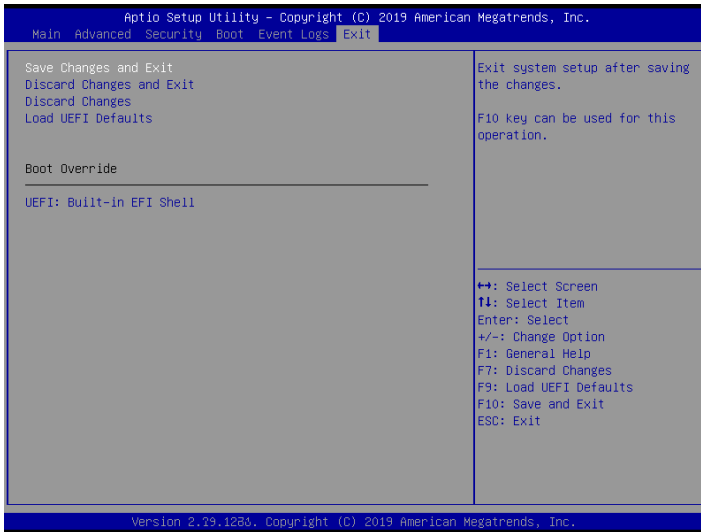

### Save Changes and Exit

When you select this option, the following message “Save configuration changes and exit setup?” will pop-out. Press <F10> key or select [Yes] to save the changes and exit the UEFI SETUP UTILITY.

### Discard Changes and Exit

When you select this option, the following message “Discard changes and exit setup?” will pop-out. Press <ESC> key or select [Yes] to exit the UEFI SETUP UTILITY without saving any changes.

### Discard Changes

When you select this option, the following message “Discard changes?” will pop-out. Press <F7> key or select [Yes] to discard all changes.

### Load UEFI Defaults

Load UEFI default values for all the setup questions. F9 key can be used for this operation.

# Chapter 4 Software Support

## 4.1 Install Operating System

This motherboard supports various Microsoft® Windows® / Linux compliant. Because motherboard settings and hardware options vary, use the setup procedures in this chapter for general reference only. Refer to your OS documentation for more information.

*\*Please download the Intel® SATA Floppy Image driver from the ASRock Rack's website ([www.asrockrack.com](http://www.asrockrack.com)) to your USB drive or simply install the SATA driver from the Support CD while installing OS in SATA RAID mode.*

## 4.2 Support CD Information

The Support CD that came with the motherboard contains necessary drivers and useful utilities that enhance the motherboard's features.

### 4.2.1 Running The Support CD

To begin using the support CD, insert the CD into your CD-ROM drive. The CD automatically displays the Main Menu if "AUTORUN" is enabled in your computer. If the Main Menu does not appear automatically, locate and double click on the file "ASRSetup.exe" from the root folder in the Support CD to display the menu.

### 4.2.2 Drivers Menu

The Drivers Menu shows the available device's drivers if the system detects installed devices. Please install the necessary drivers to activate the devices.

### 4.2.3 Utilities Menu

The Utilities Menu shows the application softwares that the motherboard supports. Click on a specific item then follow the installation wizard to install it.

### 4.2.4 Contact Information

If you need to contact ASRock Rack or want to know more about ASRock Rack, welcome to visit ASRock Rack's website at <http://www.ASRockRack.com>; or you may contact your dealer for further information.

# Chapter 5 Troubleshooting

## 5.1 Troubleshooting Procedures

Follow the procedures below to troubleshoot your system.



*Always unplug the power cord before adding, removing or changing any hardware components. Failure to do so may cause physical injuries to you and damages to motherboard components.*

1. Disconnect the power cable and check whether the PWR LED is off.
2. Unplug all cables, connectors and remove all add-on cards from the motherboard.  
Make sure that the jumpers are set to default settings.
3. Confirm that there are no short circuits between the motherboard and the chassis.
4. Install a CPU and fan on the motherboard, then connect the chassis speaker and power LED.

### **If there is no power...**

1. Confirm that there are no short circuits between the motherboard and the chassis.
2. Make sure that the jumpers are set to default settings.
3. Check the settings of the 115V/230V switch on the power supply.
4. Verify if the battery on the motherboard provides ~3VDC. Install a new battery if it does not.

### **If there is no video...**

1. Try replugging the monitor cables and power cord.
2. Check for memory errors.

### **If there are memory errors...**

1. Verify that the DIMM modules are properly seated in the slots.
2. Use recommended DDR4 ECC/non-ECC UDIMMs.
3. If you have installed more than one DIMM modules, they should be identical with the same brand, speed, size and chip-type.
4. Try inserting different DIMM modules into different slots to identify faulty ones.
5. Check the settings of the 115V/230V switch on the power supply.

---

**Unable to save system setup configurations...**

1. Verify if the battery on the motherboard provides ~3VDC. Install a new battery if it does not.
2. Confirm whether your power supply provides adequate and stable power.

**Other problems...**

1. Try searching keywords related to your problem on ASRock Rack's FAQ page:  
<http://www.asrockrack.com/support>

## 5.2 Technical Support Procedures

If you have tried the troubleshooting procedures mentioned above and the problems are still unsolved, please contact ASRock Rack's technical support with the following information:

1. Your contact information
2. Model name, BIOS version and problem type.
3. System configuration.
4. Problem description.

You may contact ASRock Rack's technical support at:

<http://www.asrockrack.com/support/tsd.asp>

## 5.3 Returning Merchandise for Service

For warranty service, the receipt or a copy of your invoice marked with the date of purchase is required. By calling your vendor or going to our RMA website (<http://event.asrockrack.com/tsd.asp>) you may obtain a Returned Merchandise Authorization (RMA) number.

The RMA number should be displayed on the outside of the shipping carton which is mailed prepaid or hand-carried when you return the motherboard to the manufacturer. Shipping and handling charges will be applied for all orders that must be mailed when service is complete.

This warranty does not cover damages incurred in shipping or from failure due to alteration, misuse, abuse or improper maintenance of products.

Contact your distributor first for any product related problems during the warranty period.