



**OPEN** Industry Standard, Flexible Architecture

**GREEN** Less Heat, Less Power Consumption

**STABLE** Robust Design, Quality Parts

Stable and  
Reliable Solution

**Server/Workstation**  
Motherboard

**E3C246D2I**

**E3C242D2I**

**C246 WSI**

**User Manual**

English



Version 1.0

Published July 2020

Copyright©2020 ASRock Rack Inc. All rights reserved.

## Copyright Notice:

No part of this documentation may be reproduced, transcribed, transmitted, or translated in any language, in any form or by any means, except duplication of documentation by the purchaser for backup purpose, without written consent of ASRock Rack Inc.

Products and corporate names appearing in this documentation may or may not be registered trademarks or copyrights of their respective companies, and are used only for identification or explanation and to the owners' benefit, without intent to infringe.

## Disclaimer:

Specifications and information contained in this documentation are furnished for informational use only and subject to change without notice, and should not be constructed as a commitment by ASRock Rack. ASRock Rack assumes no responsibility for any errors or omissions that may appear in this documentation.

With respect to the contents of this documentation, ASRock Rack does not provide warranty of any kind, either expressed or implied, including but not limited to the implied warranties or conditions of merchantability or fitness for a particular purpose.

In no event shall ASRock Rack, its directors, officers, employees, or agents be liable for any indirect, special, incidental, or consequential damages (including damages for loss of profits, loss of business, loss of data, interruption of business and the like), even if ASRock Rack has been advised of the possibility of such damages arising from any defect or error in the documentation or product.



This device complies with Part 15 of the FCC Rules. Operation is subject to the following two conditions:

- (1) this device may not cause harmful interference, and
- (2) this device must accept any interference received, including interference that may cause undesired operation.

## CALIFORNIA, USA ONLY

The Lithium battery adopted on this motherboard contains Perchlorate, a toxic substance controlled in Perchlorate Best Management Practices (BMP) regulations passed by the California Legislature. When you discard the Lithium battery in California, USA, please follow the related regulations in advance.

“Perchlorate Material-special handling may apply, see [www.dtsc.ca.gov/hazardouswaste/perchlorate](http://www.dtsc.ca.gov/hazardouswaste/perchlorate)”

**ASRock Rack's Website: [www.ASRockRack.com](http://www.ASRockRack.com)**

## Contact Information

If you need to contact ASRock Rack or want to know more about ASRock Rack, you're welcome to visit ASRock Rack's website at [www.ASRockRack.com](http://www.ASRockRack.com); or you may contact your dealer for further information.

### **ASRock Rack Incorporation**

6F., No.37, Sec. 2, Jhongyang S. Rd., Beitou District,

Taipei City 112, Taiwan (R.O.C.)

The terms HDMI® and HDMI High-Definition Multimedia Interface, and the HDMI logo are trademarks or registered trademarks of HDMI Licensing LLC in the United States and other countries.



## Contents

<b>Chapter 1 Introduction</b>	<b>1</b>
1.1 Package Contents	1
1.2 Specifications	2
1.3 Unique Features	6
1.4 Motherboard Layout	7
1.5 Onboard LED Indicators	11
1.6 I/O Panel	12
1.7 Block Diagram	14
<b>Chapter 2 Installation</b>	<b>16</b>
2.1 Screw Holes	16
2.2 Pre-installation Precautions	16
2.3 Installing the CPU	17
2.4 Installing the CPU Fan and Heatsink	19
2.5 Installation of Memory Modules (DIMM)	20
2.6 Expansion Slot (PCI Express Slot)	21
2.7 Jumper Setup	22
2.8 Onboard Headers and Connectors	24
2.9 AC-IN / DC-IN Power Connections	30
2.10 Unit Identification purpose LED/Switch	31
2.11 Driver Installation Guide	31
2.12 Dual LAN and Teaming Operation Guide	32
2.13 M.2_SSD (NGFF) Module Installation Guide (M2_1)	33

<b>Chapter 3 UEFI Setup Utility</b>	<b>34</b>
3.1 Introduction	34
3.1.1 UEFI Menu Bar	34
3.1.2 Navigation Keys	35
3.2 Main Screen	36
3.3 Advanced Screen	37
3.3.1 CPU Configuration	38
3.3.2 DRAM Configuration	41
3.3.3 Chipset Configuration	42
3.3.4 Storage Configuration	45
3.3.5 ACPI Configuration	46
3.3.6 USB Configuration	47
3.3.7 Super IO Configuration	48
3.3.8 Serial Port Console Redirection	50
3.3.9 H/W Monitor	54
3.3.10 Runtime Error Logging	56
3.3.11 Intel SPS Configuration <i>(E3C246D21 / E3C242D21 only)</i> / Server ME Configuration <i>(C246 WSI only)</i>	58
3.3.12 Intel(R) Bios Guard Technology	59
3.3.13 Instant Flash	60
3.4 Server Mgmt (E3C246D21 / E3C242D21 only)	61
3.4.1 System Event Log	62
3.4.2 BMC Network Configuration	63
3.5 Security	65
3.5.1 Key Management	66

3.6	Boot Screen	70
3.6.1	CSM Parameters	72
3.7	Event Logs	74
3.8	Exit Screen	75
<b>Chapter 4 Software Support</b>		<b>76</b>
4.1	Install Operating System	76
4.2	Support CD Information	76
4.2.1	Running The Support CD	76
4.2.2	Drivers Menu	76
4.2.3	Utilities Menu	76
4.2.4	Contact Information	76
<b>Chapter 5 Troubleshooting</b>		<b>77</b>
5.1	Troubleshooting Procedures	77
5.2	Technical Support Procedures	79
5.3	Returning Merchandise for Service	79

# Chapter 1 Introduction

Thank you for purchasing ASRock Rack **E3C246D2I / E3C242D2I / C246 WSI** motherboard, a reliable motherboard produced under ASRock Rack's consistently stringent quality control. It delivers excellent performance with robust design conforming to ASRock Rack's commitment to quality and endurance.

In this manual, chapter 1 and 2 contains introduction of the motherboard and step-by-step guide to the hardware installation. Chapter 3 and 4 contains the configuration guide to BIOS setup and information of the Support CD.



*Because the motherboard specifications and the BIOS software might be updated, the content of this manual will be subject to change without notice. In case any modifications of this manual occur, the updated version will be available on ASRock Rack website without further notice. You may find the latest memory and CPU support lists on ASRock Rack website as well. ASRock Rack's Website: [www.ASRockRack.com](http://www.ASRockRack.com)*

*If you require technical support related to this motherboard, please visit our website for specific information about the model you are using.  
<http://www.asrockrack.com/support/>*

## 1.1 Package Contents

- ASRock Rack E3C246D2I / E3C242D2I / C246 WSI Motherboard  
(Mini ITX Form Factor: 6.7-in x 6.7-in, 17.02 cm x17.02 cm)
- Support CD (C246 WSI only)
- Quick Installation Guide
- 1 x SATA3 Cable (60cm)
- 1 x SATA Power Cable (80cm)
- 1 x ATX 4P to 24P Power Cable
- 1 x I/O Shield
- 1 x Screw for M.2 Socket



*If any items are missing or appear damaged, contact your authorized dealer.*

## 1.2 Specifications

<b>E3C246D2I / E3C242D2I / C246 WSI</b>	
<b>MB Physical Status</b>	
Form Factor	Mini ITX
Dimension	6.7" x 6.7" (17.02cm x17.02 cm)
<b>Processor System</b>	
CPU	Supports Intel® Xeon® E-2100 Processors
Chipset	Intel® C246 / C242
<b>System Memory</b>	
Capacity	2 x DDR4 DIMM slots
Type	- Dual Channel memory technology - Supports DDR4 2133/2400/2666 ECC UDIMM* <i>*The non-ECC UDIMMs support Client OS only.</i>
DIMM Size Per DIMM	ECC and non-ECC UDIMM : 16GB, 8GB, 4GB
Voltage	1.2V
<b>Expansion Slot</b>	
PCIe 3.0 x16	1 slot
<b>Storage</b>	
SATA Controller	C246: 1x OCULINK (SATA_0,1,2,3) , 4x SATA3 6Gb/s (SATA_4,5,6,7) C242: 1x OCULINK (SATA_0,1,2,3), 2x SATA3 6Gb/s (SATA_4,5) <i>*Please contact sales to buy the OCuLink to 4x SATA cable.</i>
NVMe Devices	<b>C246 WSI / E3C246D2I:</b> NVMe SSDs PCIeEx4 (Share with SATA_0,1,2,3) <b>E3C242D2I:</b> N/A
M.2	- 1 x M.2 (NGFF 2242, PCI-E Gen3 x4 link or SATA signal)* <i>*SATA 1 will be disabled when M.2 is SATA signal.</i>
<b>Audio</b>	
Audio Codec	<b>E3C246D2I / E3C242D2I :</b> N/A <b>C246 WSI :</b> Realtek ALC892
<b>Ethernet</b>	
Interface	1000 /100 /10 Mbps
LAN	- 2 x RJ45 GLAN by Intel® i210+Intel® i219LM - Supports Wake-On-LAN - Supports Energy Efficient Ethernet 802.3az - Supports PXE
<b>Graphics</b>	
Controller	<b>E3C246D2I / E3C242D2I:</b> ASPEED AST2500 <b>C246 WSI:</b> CPU pGFX
VRAM	<b>E3C246D2I / E3C242D2I:</b> DDR4 16MB <b>C246 WSI:</b> N/A



Rear Panel I/O	
VGA Port	1 x D-Sub
USB 2.0 Port	2
USB 3.1 Port	<b>E3C242D2I</b> : 2 (Gen2), 2(Gen1) <b>E3C246D2I / C246 WSI</b> : 4 (Gen2)
LAN Port	- RJ45: 2x GLAN(by Intel® i210+ Intel® i219LM) - LAN Ports with LED (ACT/LINK LED and SPEED LED)
Management LAN Port	<b>E3C246D2I / E3C242D2I</b> : 1 <b>C246 WSI</b> : N/A
Display Port	<b>E3C246D2I / E3C242D2I</b> : N/A <b>C246 WSI</b> : 1
HDMI Port	<b>E3C246D2I / E3C242D2I</b> : N/A <b>C246 WSI</b> : 1
Audio	<b>E3C246D2I / E3C242D2I</b> : N/A <b>C246 WSI</b> : 3 Jack
SPDIF	<b>E3C246D2I / E3C242D2I</b> : N/A <b>C246 WSI</b> : 1
UID	<b>E3C246D2I / E3C242D2I</b> : 1 <b>C246 WSI</b> : N/A
Internal Connector	
Auxiliary Panel Header	1 (includes chassis intrusion, front LAN LED)
TR1	1
TPM Header	1
Fan Header	3 (1CPU/1Front/1Rear)
ATX power DC-IN	1x (8-pin)
SATA Port	3
SATADOM	1
ATX Power	1x (4-pin)
SATA Power	1x (4-pin)
OCuLink	1
USB 3.0 Header	1 (supports 2 USB3.0)
ClearCMOS	1 (short pad)
SGPIO	2
Front Panel Audio	<b>E3C246D2I / E3C242D2I</b> : N/A <b>C246 WSI</b> : 1
Speaker	1
COM Header	1
IPMB	<b>E3C246D2I / E3C242D2I</b> : 1 <b>C246 WSI</b> : N/A
PWR SMB	<b>E3C246D2I / E3C242D2I</b> : 1 <b>C246 WSI</b> : N/A

<b>System BIOS</b>	
BIOS Type	128Mb AMI UEFI Legal BIOS
BIOS Features	<ul style="list-style-type: none"> <li>- Plug and Play (PnP)</li> <li>- ACPI 2.0 Compliance Wake Up Events</li> <li>- SMBIOS 2.8.0 Support</li> <li>- ASRock Rack Instant Flash</li> </ul>
<b>Hardware Monitor</b>	
Temperature	<ul style="list-style-type: none"> <li>- CPU/PCH/DDR/LAN/Storage Temperature Sensing</li> <li>- MB/Card side/TR1 Temperature Sensing</li> </ul>
Fan	<ul style="list-style-type: none"> <li>- CPU/Rear/Front Fan Tachometer</li> <li>- CPU Quiet Fan (Allow Chassis Fan Speed Auto-Adjust by CPU Temperature)</li> <li>- CPU/Rear/Front Fan Multi-Speed Control</li> </ul>
Voltage	<p><b>E3C246D2I / E3C242D2I:</b>  Voltage Monitoring: +12V, +5V, +3.3V, CPU Vcore, DRAM, 1.05V_PCH, +BAT, 3VSB, 5VSB</p> <p><b>C246 WSI :</b>  Voltage Monitoring: 3V, Vcore, 12V, VCCST_SFR, 3VSB</p>
<b>Support OS</b>	
OS	<p><b>E3C246D2I and E3C242D2I:</b></p> <p>Microsoft® Windows®</p> <ul style="list-style-type: none"> <li>- Server 2016 (64 bit)</li> <li>- Server 2019 (64 bit)</li> </ul> <p>Linux®</p> <ul style="list-style-type: none"> <li>- RedHat Enterprise Linux Server 6.10 (64 bit) / 7.5 (64 bit)</li> <li>- SUSE Enterprise Linux Server 11 SP4 (64 bit) / 12 SP3 (64 bit)</li> <li>- Ubuntu 16.04 (64 bit)/ 18.04 (64 bit)</li> </ul> <p>Virtual</p> <ul style="list-style-type: none"> <li>- VMWare® ESXi 6.5 u1</li> <li>- Win hyper-V Server 2016</li> </ul> <p><b>C246 WSI:</b></p> <p>Microsoft® Windows®:</p> <p>Windows 10 (64 bit)</p> <p>Linux®</p> <ul style="list-style-type: none"> <li>- RedHat Enterprise Linux Server 6.10 (64 bit) / 7.5 (64 bit)</li> <li>- SUSE Enterprise Linux Server 11 SP4 (64 bit) / 12 SP3 (64 bit)</li> <li>- Ubuntu 16.04 (64 bit)/ 18.04 (64 bit)</li> </ul> <p>Virtual</p> <ul style="list-style-type: none"> <li>- VMWare® ESXi 6.5 u1</li> <li>- Win hyper-V Server 2016</li> </ul> <p><i>* Please refer to our website for the latest OS support list.</i></p>

**Environment****Temperature**

Operation temperature: 10°C ~ 35°C / Non operation temperature: -40°C ~ 70°C

*NOTE: Please refer to our website for the latest specifications.*



*This motherboard supports Wake from on Board LAN. To use this function, please make sure that the "Wake on Magic Packet from power off state" is enabled in Device Manager > Intel® Ethernet Connection > Power Management. And the "PCI Devices Power On" is enabled in UEFI SETUP UTILITY > Advanced > ACPI Configuration. After that, onboard LAN1&2 can wake up S5 under OS.*



*If you install Intel® LAN utility or Marvell SATA utility, this motherboard may fail Windows® Hardware Quality Lab (WHQL) certification tests. If you install the drivers only, it will pass the WHQL tests.*

## 1.3 Unique Features

ASRock Rack Instant Flash is a BIOS flash utility embedded in Flash ROM. This convenient BIOS update tool allows you to update system BIOS without entering operating systems first like MS-DOS or Windows. With this utility, you can press the <F6> key during the POST or the <F2> key to enter into the BIOS setup menu to access ASRock Rack Instant Flash. Just launch this tool and save the new BIOS file to your USB flash drive, floppy disk or hard drive, then you can update your BIOS only in a few clicks without preparing an additional floppy diskette or other complicated flash utility. Please be noted that the USB flash drive or hard drive must use FAT32/16/12 file system.

# 1.4 Motherboard Layout

## E3C246D2I / E3C242D2I

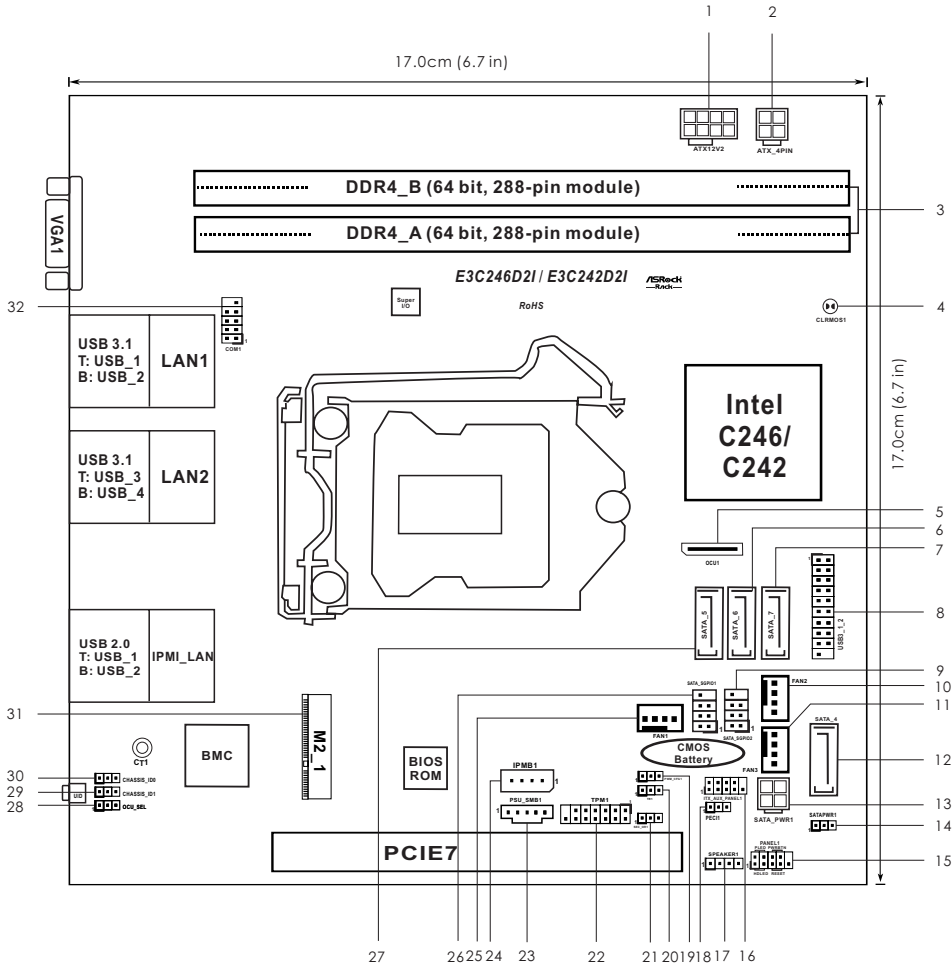

No.	Description
1	ATX 12V Power Connector (ATX12V2)
2	ATX 4-PIN Power Connector (ATX_4PIN)
3	2 x 288-pin DDR4 DIMM Slots (DDR4_A, DDR4_B)
4	Clear CMOS Pad (CLRMOSE1)
5	OCuLink x4 Connector (OCU1)
6	SATA3 Connector (SATA_6) <i>(for E3C246D21 only)</i>
7	SATA3 Connector (SATA_7) <i>(for E3C246D21 only)</i>
8	USB 3.0 Header (USB3_1_2)
9	SATA SGPIO Connector (SATA_SGPIO2)
10	Front Fan Connector (FAN2)
11	Rear Fan Connector (FAN3)
12	SATA3 Connector (SATA_4)
13	SATA Power Connector (SATA_PWR1)
14	SATA DOM Power Jumper (SATAPWR1)
15	System Panel Header (PANEL1)
16	Auxiliary Panel Header (ITX_AUX_PANEL1)
17	Speaker Header (SPEAKER1)
18	CPU PECE Mode Jumper (PECE1)
19	PWM Configuration Header (PWM_CFG1)
20	Thermal Sensor Header (TR1)
21	Security Override Jumper (SEC_OR1)
22	TPM Header (TPM1)
23	PSU SMBus (PSU_SMB1)
24	Intelligent Platform Management Bus header (IPMB1)
25	CPU Fan Connector (FAN1)
26	SATA SGPIO Connector (SATA_SGPIO1)
27	SATA3 Connector (SATA_5)
28	OCuLink SATA/PCIE Interface Selection Jumper (OCU_SEL)
29	Chassis ID Jumper (CHASSIS_ID1)
30	Chassis ID Jumper (CHASSIS_ID0)
31	M.2 Socket (M2_1) (Type 2242)
32	COM Port Header (COM1)

# C246 WSI

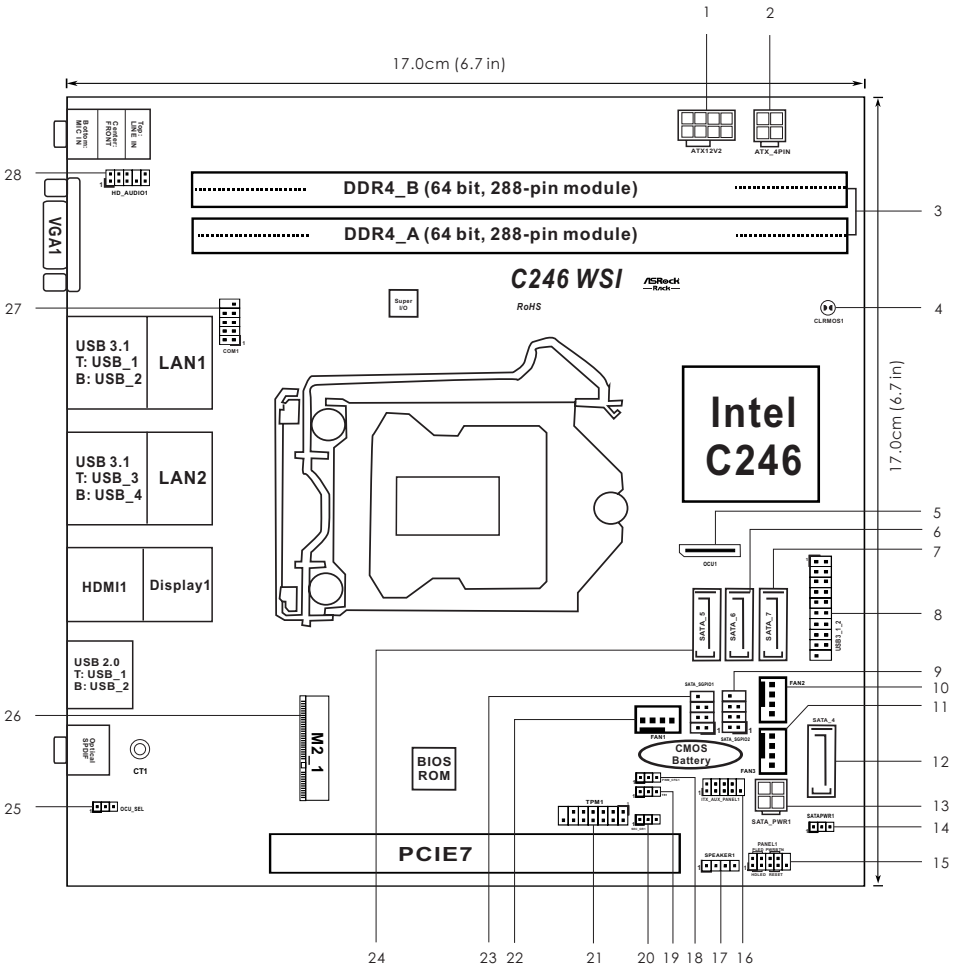

No.	Description
1	ATX 12V Power Connector (ATX12V2)
2	ATX 4PIN Power Connector (ATX_4PIN)
3	2 x 288-pin DDR4 DIMM Slots (DDR4_A, DDR4_B)
4	Clear CMOS Pad (CLRMOSE1)
5	OCuLink x4 Connector (OCU1)
6	SATA3 Connector (SATA_6)
7	SATA3 Connector (SATA_7)
8	USB 3.0 Header (USB3_1_2)
9	SATA SGPIO Connector (SATA_SGPIO2)
10	Front Fan Connector (FAN2)
11	Rear Fan Connector (FAN3)
12	SATA3 Connector (SATA_4)
13	SATA Power Connector (SATA_PWR1)
14	SATA DOM Power Jumper (SATAPWR1)
15	System Panel Header (PANEL1)
16	Auxiliary Panel Header (ITX_AUX_PANEL1)
17	Speaker Header (SPEAKER1)
18	PWM Configuration Header (PWM_CFG1)
19	Thermal Sensor Header (TR1)
20	Security Override Jumper (SEC_OR1)
21	TPM Header (TPM1)
22	CPU Fan Connector (FAN1)
23	SATA SGPIO Connector (SATA_SGPIO1)
24	SATA3 Connector (SATA_5)
25	OCuLink SATA/PCIE Interface Selection Jumper (OCU_SEL)
26	M.2 Socket (M2_1) (Type 2242)
27	COM Port Header (COM1)
28	Front Panel Audio Header (HD_AUDIO1)



## 1.5 Onboard LED Indicators

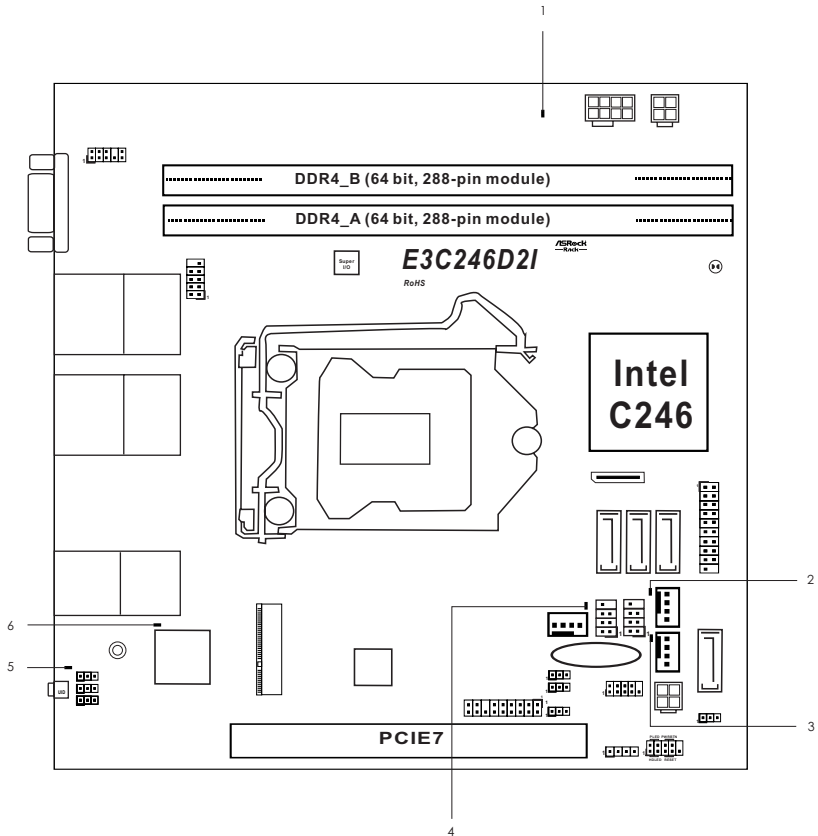

No.	Item	Status	Description
1	SB_PWR1	Green	STB PWR ready
2	FAN_LED2	Red	FAN2 failed
3	FAN_LED3	Red	FAN3 failed
4	FAN_LED1	Red	FAN1 failed
5	UID_LED1	Blue	Unit Identification LED* *Please see 2.9 "Unit Identification purpose LED/ Switch" for more information.
6	BMC_LED1	Green	BMC heartbeat LED

## 1.6 I/O Panel

### E3C246D2I / E3C242D2I

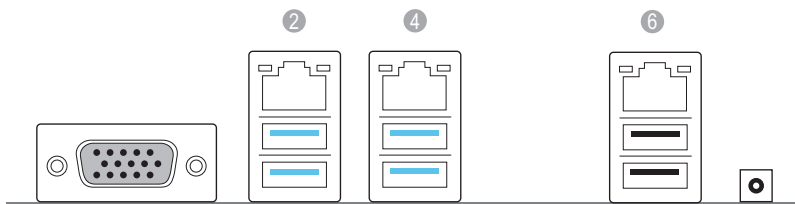

No.	Description	No.	Description
1	VGA Port (VGA1)	5	USB 3.1 Gen2 Ports (USB31_3_4)
2	LAN RJ-45 Port (LAN1)**	6	LAN RJ-45 Port (IPMI_LAN)*
3	<b>E3C246D2I:</b> USB 3.1 Gen2 Ports (USB31_1_2) <b>E3C242D2I:</b> USB 3.1 Gen1 Ports (USB31_1_2)	7	USB 2.0 Ports (USB_1_2)
4	LAN RJ-45 Port (LAN2)**	8	UID Switch (UID1)

### C246 WSI

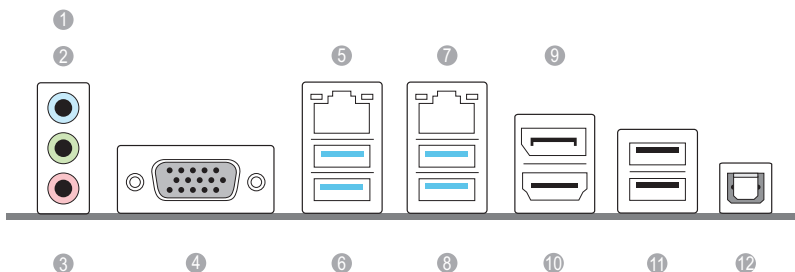

No.	Description	No.	Description
1	Line In (Light Blue)	7	LAN RJ-45 Port (LAN2)**
2	Front Speaker (Lime)	8	USB 3.1 Gen2 Ports (USB31_3_4)
3	Microphone (Pink)	9	Display Port
4	VGA Port (VGA1)	10	HDMI Port
5	LAN RJ-45 Port (LAN1)**	11	USB 2.0 Ports (USB_1_2)
6	USB 3.1 Gen2 Ports (USB31_1_2)	12	Optical SPDIF Out Port (SPDIF1)

## LAN Port LED Indications

\*There are two LEDs on each LAN port. Please refer to the table below for the LAN port LED indications.

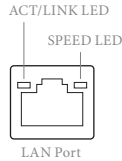

### Dedicated IPMI LAN Port LED Indications

Activity / Link LED		Speed LED	
Status	Description	Status	Description
Off	No Link	Off	10Mbps connection or no link
Blinking Yellow	Data Activity	Yellow	100Mbps connection
On	Link	Green	1Gbps connection

\*\*There are two LEDs on each LAN port. Please refer to the table below for the LAN port LED indications.

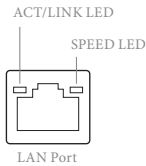

### LAN Port LED Indications

Activity / Link LED		Speed LED	
Status	Description	Status	Description
Off	No Link	Off	10M bps connection or no link
Blinking Yellow	Data Activity	Yellow	100M bps connection
On	Link	Green	1Gbps connection

# 1.7 Block Diagram

## E3C246D2I / E3C242D2I

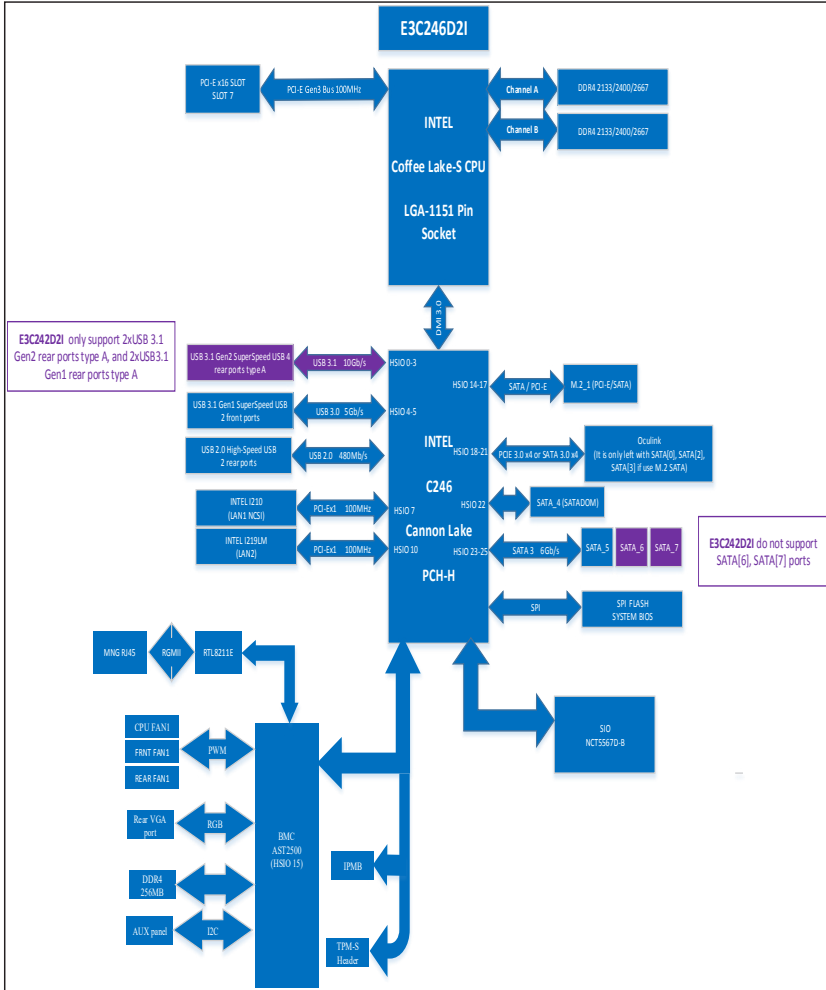

## C246 WSI

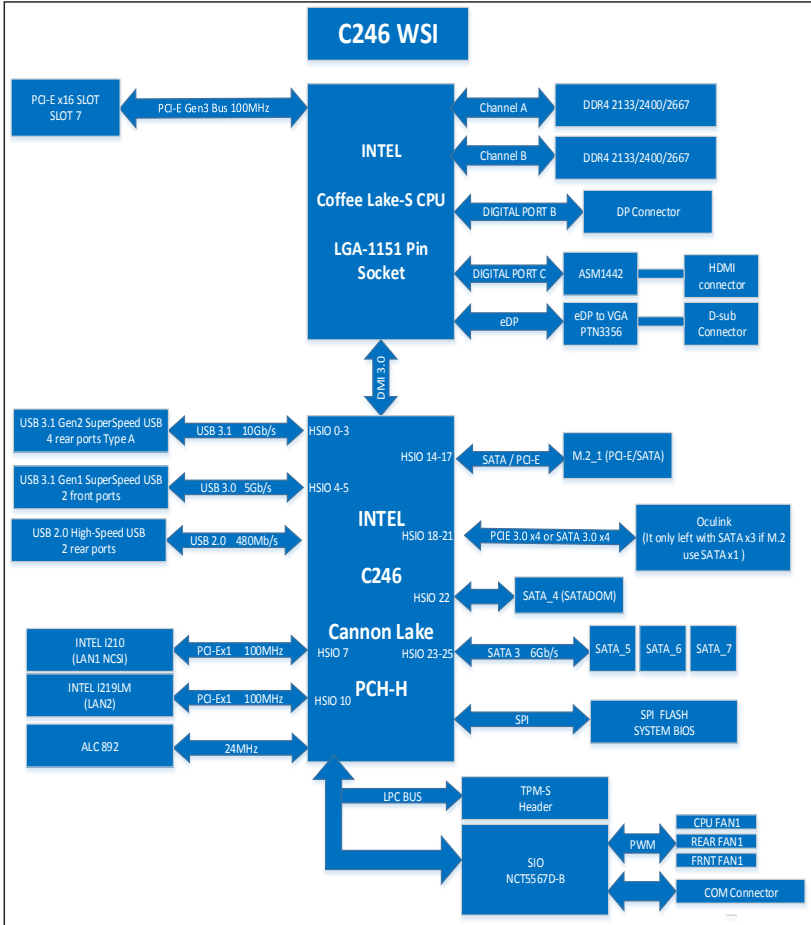

# Chapter 2 Installation

This is a mini ITX form factor (6.7" x 6.7", 17.02 cm x 17.02 cm) motherboard. Before you install the motherboard, study the configuration of your chassis to ensure that the motherboard fits into it.



*Make sure to unplug the power cord before installing or removing the motherboard. Failure to do so may cause physical injuries to you and damages to motherboard components.*

## 2.1 Screw Holes

Place screws into the holes indicated by circles to secure the motherboard to the chassis.



*Do not over-tighten the screws! Doing so may damage the motherboard.*

## 2.2 Pre-installation Precautions

Take note of the following precautions before you install motherboard components or change any motherboard settings.

1. Unplug the power cord from the wall socket before touching any components.
2. To avoid damaging the motherboard's components due to static electricity, NEVER place your motherboard directly on the carpet or the like. Also remember to use a grounded wrist strap or touch a safety grounded object before you handle the components.
3. Hold components by the edges and do not touch the ICs.
4. Whenever you uninstall any component, place it on a grounded anti-static pad or in the bag that comes with the component.
5. When placing screws into the screw holes to secure the motherboard to the chassis, please do not over-tighten the screws! Doing so may damage the motherboard.



*Before you install or remove any component, ensure that the power is switched off or the power cord is detached from the power supply. Failure to do so may cause severe damage to the motherboard, peripherals, and/or components.*

## 2.3 Installing the CPU



1. Before you insert the 1151-Pin CPU into the socket, please check if the PnP cap is on the socket, if the CPU surface is unclean, or if there are any bent pins in the socket. Do not force to insert the CPU into the socket if above situation is found. Otherwise, the CPU will be seriously damaged.
2. Unplug all power cables before installing the CPU.



Illustrations in this User Manual are provided for reference only and may slightly differ from actual product appearances.

1

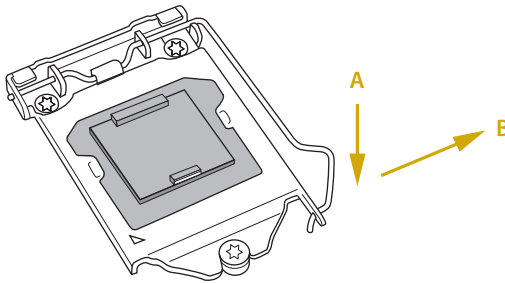

2

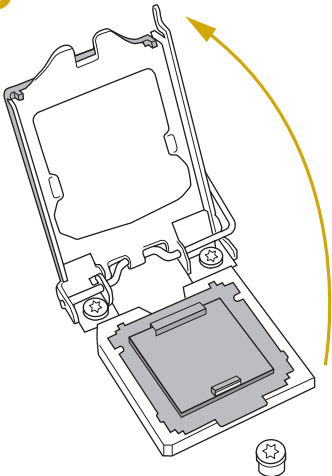

3

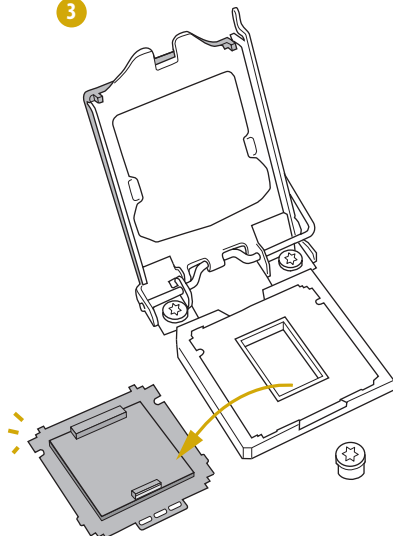

4

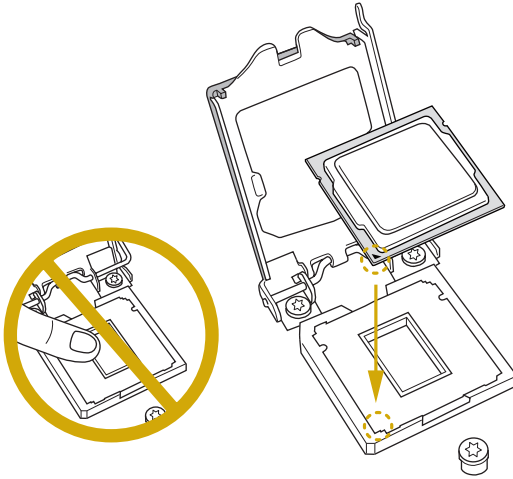

5

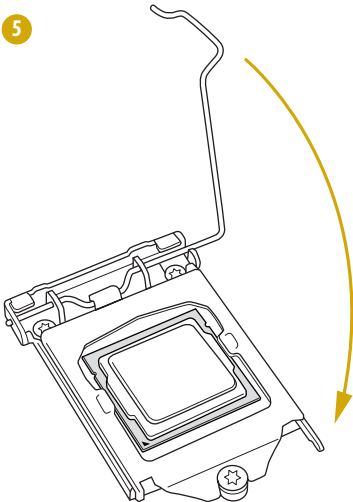

6

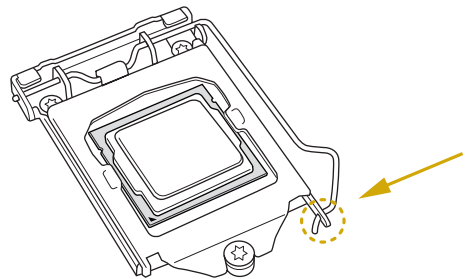

Please save and replace the cover if the processor is removed. The cover must be placed if you wish to return the motherboard for after service.



## 2.4 Installing the CPU Fan and Heatsink

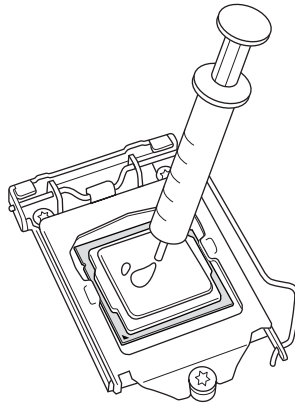

1

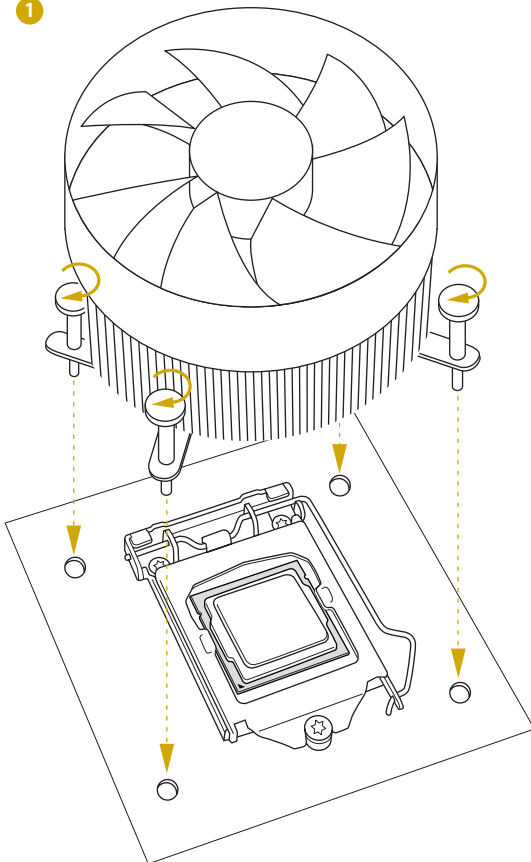

2

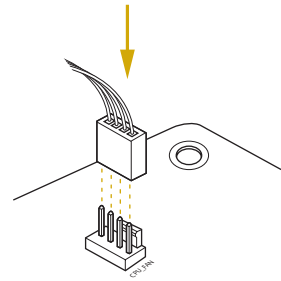

## 2.5 Installation of Memory Modules (DIMM)

This motherboard provides two 288-pin DDR4 (Double Data Rate 4) DIMM slots.



1. It is not allowed to install a DDR, DDR2 or DDR3 memory module into a DDR4 slot; otherwise, this motherboard and DIMM may be damaged.
2. The DIMM only fits in one correct orientation. It will cause permanent damage to the motherboard and the DIMM if you force the DIMM into the slot at incorrect orientation.

1

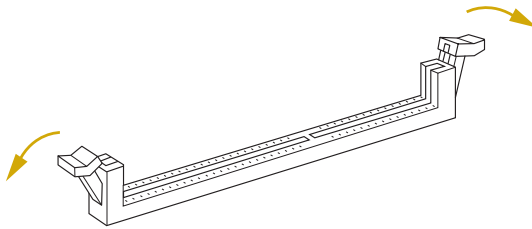

2

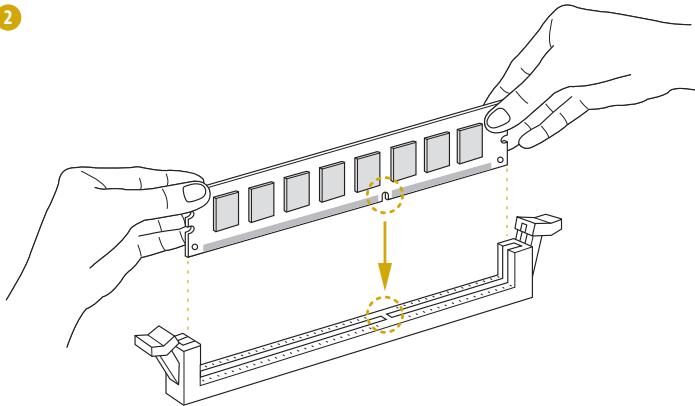

3

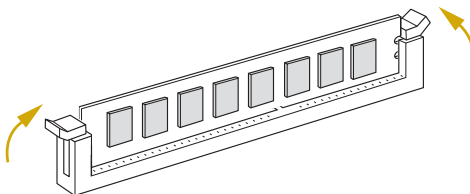

## 2.6 Expansion Slot (PCI Express Slot)

There is a PCI Express slot on this motherboard.

### PCIe slot:

PCIe7 (PCIe 3.0 x16 slot) is used for PCI Express x16 lane width cards.

Slot	Generation	Mechanical	Electrical	Source
PCIe 7	3.0	x16	x16	CPU

### Installing an expansion card

- Step 1. Before installing an expansion card, please make sure that the power supply is switched off or the power cord is unplugged. Please read the documentation of the expansion card and make necessary hardware settings for the card before you start the installation.
- Step 2. Remove the system unit cover (if your motherboard is already installed in a chassis).
- Step 3. Remove the bracket facing the slot that you intend to use. Keep the screws for later use.
- Step 4. Align the card connector with the slot and press firmly until the card is completely seated on the slot.
- Step 5. Fasten the card to the chassis with screws.
- Step 6. Replace the system cover.

## 2.7 Jumper Setup

The illustration shows how jumpers are setup. When the jumper cap is placed on the pins, the jumper is “Short”. If no jumper cap is placed on the pins, the jumper is “Open”. The illustration shows a 3-pin jumper whose pin1 and pin2 are “Short” when a jumper cap is placed on these 2 pins.

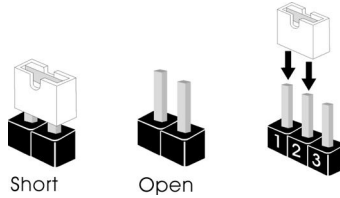

Security Override Jumper  
(3-pin SEC\_OR1)



Descriptor Security  
Override



Not override (Default)

OCuLink SATA/PCIE  
Interface Selection Jumper  
(3-pin OCU\_SEL)



For PCIE (Default)



For SATA

CPU PECI Mode Jumper  
(3-pin PECI1)





*(E3C246D21 / E3C242D21 only)*









CPU PECI connected to  
PCH



CPU PECI connected to  
BMC (Default)

CHASSIS ID Jumpers (3-pin CHASSIS_ID0)	<b>1_2</b> 	<b>1_2</b> 
(3-pin CHASSIS_ID1) (E3C246D2I / E3C242D2I only)	<b>1_2</b> 	<b>2_3</b> 
	Board Level SKU (Default)	Reserved for system level use

CHASSIS ID Jumpers (3-pin CHASSIS_ID0)	<b>2_3</b> 	<b>2_3</b> 
(3-pin CHASSIS_ID1) (E3C246D2I / E3C242D2I only)	<b>1_2</b> 	<b>2_3</b> 
	Reserved for system level use	Reserved for system level use

SATA DOM Power Jumper (3-pin SATAPWR1)	<b>1_2</b> 	<b>2_3</b> 
	SATA DOM (SATA_4) requires 5V power supply	SATA DOM (SATA_4) does NOT require 5V power supply (Default)



Consult the documentation that comes with your SATA DOM and check whether or not Pin 7 requires 5V power supply.

If the connected SATA DOM requires 5V power supply, move the jumper caps placed on the SATA DOM Power Jumper (SATAPWR1) from pins 2-3 (default) to pins 1-2.

If the connected SATA DOM does NOT require 5V power supply, connect the SATA DOM power cable to the SATA DOM power header (SATAPWR1) and there is no need to change the default jumper setting of the SATA DOM Power Jumper (pins 2-3).

**Warning!** Incorrect setting of the SATA DOM Power Jumper (SATAPWR1) may cause damage to the motherboard or your SATA DOM.

## 2.8 Onboard Headers and Connectors



Onboard headers and connectors are NOT jumpers. Do NOT place jumper caps over these headers and connectors. Placing jumper caps over the headers and connectors will cause permanent damage to the motherboard.

### System Panel Header (9-pin PANEL1)

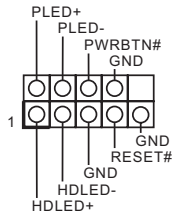

Connect the power switch, reset switch and system status indicator on the chassis to this header according to the pin assignments. Particularly note the positive and negative note the positive and negative pins before connecting the cables.



#### **PWRBTN (Power Switch):**

Connect to the power switch on the chassis front panel. You may configure the way to turn off your system using the power switch.

#### **RESET (Reset Switch):**

Connect to the reset switch on the chassis front panel. Press the reset switch to restart the computer if the computer freezes and fails to perform a normal restart.

#### **PLED (System Power LED):**

Connect to the power status indicator on the chassis front panel. The LED is on when the system is operating. The LED is off when the system is in S4 sleep state or powered off (S5).

#### **HDLED (Hard Drive Activity LED):**

Connect to the hard drive activity LED on the chassis front panel. The LED is on when the hard drive is reading or writing data.

The front panel design may differ by chassis. A front panel module mainly consists of power switch, reset switch, power LED, hard drive activity LED, speaker and etc. When connecting your chassis front panel module to this header, make sure the wire assignments and the pin assignments are matched correctly.

### Auxiliary Panel Header (9-pin ITX\_AUX\_PANEL1)

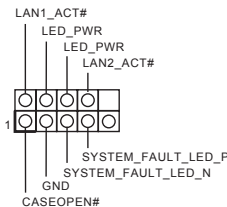

This header supports multiple functions on the front panel, including front panel SMB, internet status indicator.

### Serial ATA3 Connectors (SATA\_5)

(for E3C246D2I / C246 WSI  
only)

(SATA\_6)  
(SATA\_7)



These SATA3 connectors support SATA data cables for internal storage devices with up to 6.0 Gb/s data transfer rate.

### Serial ATA3 DOM Connector (SATA\_0)



The SATA3 DOM connector supports both a SATA DOM (Disk-On-Module) and a SATA data cable for internal storage device.

### USB 3.0 Header (19-pin USB3\_1\_2)

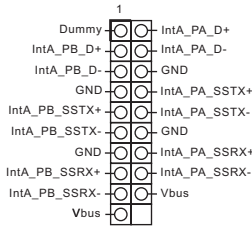

Besides four default USB 3.0 ports on the I/O panel, there is one USB 3.0 header on this motherboard. This USB 3.0 header can support two USB 3.0 ports.

### Chassis Speaker Header (4-pin SPEAKER1)

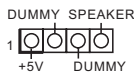

Please connect the chassis speaker to this header.

### CPU Fan Connectors (4-pin FAN1)

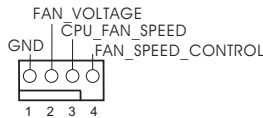

This motherboard provides one 4-Pin CPU fan (Quiet Fan) connectors. If you plan to connect a 3-Pin CPU fan, please connect it to Pin 1-3.

*\*For more details, please refer to the Cooler QVL list on the ASRock Rack website.*

### Front and Rear Fan Connectors (4-pin FAN2) (4-pin FAN3)

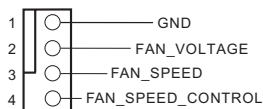

Please connect fan cables to the fan connector and match the black wire to the ground pin. All fans support Fan Control.

---

ATX 12V Power  
Connector  
(8-pin ATX12V2)

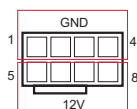

The motherboard provides one 8-pin 12V power connector which is a required input for either DC-IN 12V or ATX +12V power source.

When using ATX power, it is necessary to use a 24pin-to-4pin power cable to connect between the 24pin power connector of PSU and the ATX\_4PIN connector on the motherboard for power supply and signal communication.

---

ATX 4-PIN Power  
Connector  
(4-pin ATX\_4PIN  
(ATX 24pin-to-4pin))

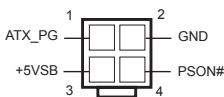

The motherboard provides one 4-pin power/signal connector which is a required input for ATX power source.

When using ATX power, it is necessary to use a 24pin-to-4pin power cable to connect between the 24pin power connector of PSU and the ATX\_4PIN connector on the motherboard for power supply and signal communication.

For DC-IN 12V application, it is not necessary to use this ATX 4-PIN power connector.

*\*Caution: Misconnection between the ATX\_4PIN and the SATA\_PWR1 connectors may permanently damage the motherboard.*



SATA Power Connector  
(DC-IN Mode)  
(4-pin SATA\_PWR1)

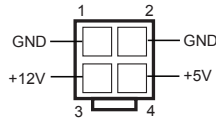

Please use a SATA power cable to connect this SATA Power Connector and your SATA HDD for supplying power from the motherboard, when using DC-IN mode without SATA power supply.

*\*Caution: Misconnection between the ATX\_4PIN and the SATA\_PWR1 connectors may permanently damage the motherboard.*

TPM Header  
(13-pin TPM1)

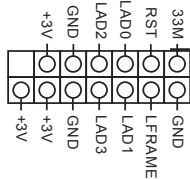

This connector supports Trusted Platform Module (TPM) system, which can securely store keys, digital certificates, passwords, and data. A TPM system also helps enhance network security, protects digital identities, and ensures platform integrity.

Serial General Purpose  
Input/Output Headers  
(7-pin SATA\_SGPIO1)  
(7-pin SATA\_SGPIO2)

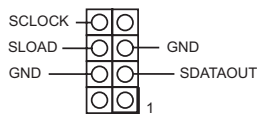

The headers support Serial Link interface for onboard SATA connections.

Thermal Sensor Header  
(3-pin TR1)



Please connect the thermal sensor cable to either pin 1-2 or pin 2-3 and the other end to the device which you wish to monitor its temperature.

Front Panel Audio Header  
(9-pin HD\_AUDIO1)  
*(C246 WSI only)*

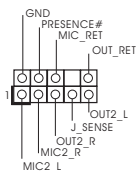

This header is for connecting audio devices to the front audio panel.

PWM Configuration Header  
(3-pin PWM\_CFG1)

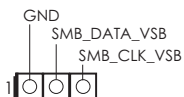

This header is used for PWM configurations.

OCuLink Connector  
(OCU1)



Please connect PCIE SSDs or OCuLink to SATA x4 cable to the connector.

Serial Port Header  
(9-pin COM1)

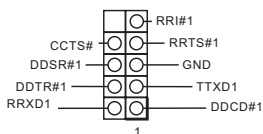

This COM header supports a serial port module.

Clear CMOS Pad  
(CLRMOS1)



CLRMOS1 allows you to clear the data in CMOS. To clear CMOS, take out the CMOS battery and short the Clear CMOS Pad.

PSU SMBus  
(PSU\_SMB1)  
*(E3C246D21 / E3C242D21 only)*

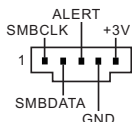

PSU SMBus monitors the status of the power supply, fan and system temperature.

Intelligent Platform  
Management Bus Header  
(4-pin IPMB1)

*(E3C246D2I / E3C242D2I only)*

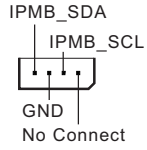

This 4-pin connector is used to provide a cabled base-board or front panel connection for value added features and 3rd-party add-in cards, such as Emergency Management cards, that provide management features using the IPMB.

## 2.9 ATX PSU / DC-IN Power Connections

This motherboard supports both +12V DC and ATX power input. Please refer to the table below for the required connections between the motherboard and the power supply.

Connector	DC-IN	ATX PSU
12V 8pin	O	O
ATX 4pin	X	O <i>(with the bundled ATX 24pin-to-4pin converter cable)</i>

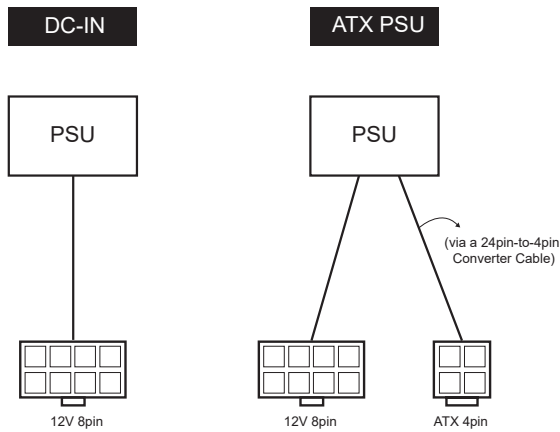

The following diagram illustrates how to connect the bundled ATX 24pin-to-4pin converter cable.

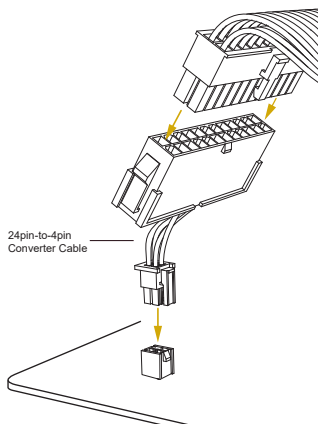

## 2.10 Unit Identification purpose LED/Switch

With the UID button, You are able to locate the server you're working on from behind a rack of servers.

Unit Identification  
purpose LED/Switch  
(UIDI)



When the UID button on the front or rear panel is pressed, the front/rear UID blue LED indicator will be turned on. Press the UID button again to turn off the indicator.

## 2.11 Driver Installation Guide

To install the drivers to your system, please insert the support CD to your optical drive first. Then, the drivers compatible to your system can be auto-detected and listed on the support CD driver page. Please follow the order from top to bottom to install those required drivers. Therefore, the drivers you install can work properly.

## 2.12 Dual LAN and Teaming Operation Guide

Dual LAN with Teaming enabled on this motherboard allows two single connections to act as one single connection for twice the transmission bandwidth, making data transmission more effective and improving the quality of transmission of distant images. Fault tolerance on the dual LAN network prevents network downtime by transferring the workload from a failed port to a working port.



*The speed of transmission is subject to the actual network environment or status even with Teaming enabled.*

Before setting up Teaming, please make sure whether your Switch (or Router) supports Teaming (IEEE 802.3ad Link Aggregation). You can specify a preferred adapter in Intel PROSet. Under normal conditions, the Primary adapter handles all non-TCP/IP traffic. The Secondary adapter will receive fallback traffic if the primary fails. If the Preferred Primary adapter fails, but is later restored to an active status, control is automatically switched back to the Preferred Primary adapter.

### **Step 1**

From **Device Manager**, open the properties of a team.

### **Step 2**

Click the **Settings** tab.

### **Step 3**

Click the **Modify Team** button.

### **Step 4**

Select the adapter you want to be the primary adapter and click the **Set Primary** button.

If you do not specify a preferred primary adapter, the software will choose an adapter of the highest capability (model and speed) to act as the default primary. If a failover occurs, another adapter becomes the primary. The adapter will, however, rejoin the team as a non-primary.

## 2.13 M.2\_SSD (NGFF) Module Installation Guide (M2\_1)

The M.2, also known as the Next Generation Form Factor (NGFF), is a small size and versatile card edge connector that aims to replace mPCIe and mSATA. This M.2\_SSD (NGFF) Socket 3 can accommodate a M.2 PCI Express module up to Gen3 x4 (32 Gb/s) only.

### Installing the M.2\_SSD (NGFF) Module

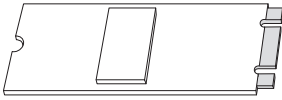

#### Step 1

Prepare a M.2\_SSD (NGFF) module and the screw.

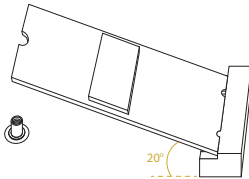

#### Step 2

Gently insert the M.2 (NGFF) SSD module into the M.2 slot. Please be aware that the M.2 (NGFF) SSD module only fits in one orientation.

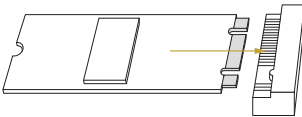

#### Step 3

Tighten the screw with a screwdriver to secure the module into place. Please do not overtighten the screw as this might damage the module.

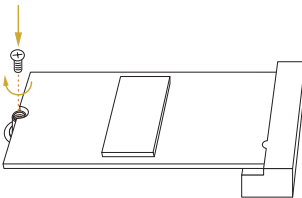

### M.2\_SSD (NGFF) Module Support List

For the latest updates of M.2\_SSD (NFGG) module support list, please visit our website for details: <http://www.asrockrack.com>

# Chapter 3 UEFI Setup Utility

## 3.1 Introduction

This section explains how to use the UEFI SETUP UTILITY to configure your system. The UEFI chip on the motherboard stores the UEFI SETUP UTILITY. You may run the UEFI SETUP UTILITY when you start up the computer. Please press <F2> or <Del> during the Power-On-Self-Test (POST) to enter the UEFI SETUP UTILITY; otherwise, POST will continue with its test routines.

If you wish to enter the UEFI SETUP UTILITY after POST, restart the system by pressing <Ctrl> + <Alt> + <Delete>, or by pressing the reset button on the system chassis. You may also restart by turning the system off and then back on.



*Because the UEFI software is constantly being updated, the following UEFI setup screens and descriptions are for reference purpose only, and they may not exactly match what you see on your screen.*

### 3.1.1 UEFI Menu Bar

The top of the screen has a menu bar with the following selections:

Item	Description
Main	To set up the system time/date information
Advanced	To set up the advanced UEFI features
Server Mgmt <small>(E3C246D21 / E3C242D21 only)</small>	To manage the server
Security	To set up the security features
Boot	To set up the default system device to locate and load the Operating System
Event Logs	For event log configuration
Exit	To exit the current screen or the UEFI SETUP UTILITY

Use <←> key or <→> key to choose among the selections on the menu bar, and then press <Enter> to get into the sub screen.



### 3.1.2 Navigation Keys

Please check the following table for the function description of each navigation key.

Navigation Key(s)	Function Description
← / →	Moves cursor left or right to select Screens
↑ / ↓	Moves cursor up or down to select items
+ / -	To change option for the selected items
<Tab>	Switch to next function
<Enter>	To bring up the selected screen
<PGUP>	Go to the previous page
<PGDN>	Go to the next page
<HOME>	Go to the top of the screen
<END>	Go to the bottom of the screen
<F1>	To display the General Help Screen
<F7>	Discard changes and exit the UEFI SETUP UTILITY
<F9>	Load optimal default values for all the settings
<F10>	Save changes and exit the UEFI SETUP UTILITY
<F12>	Print screen
<ESC>	Jump to the Exit Screen or exit the current screen

## 3.2 Main Screen

Once you enter the UEFI SETUP UTILITY, the Main screen will appear and display the system overview. The Main screen provides system overview information and allows you to set the system time and date.

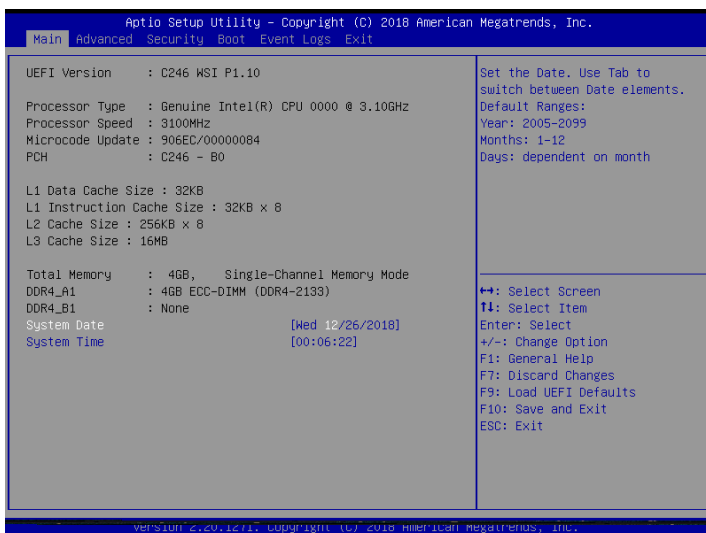

### 3.3 Advanced Screen

In this section, you may set the configurations for the following items: CPU Configuration, DRAM Configuration, Chipset Configuration, Storage Configuration, ACPI Configuration, USB Configuration, Super IO Configuration, Serial Port Console Redirection, H/W Monitor, Runtime Error Logging, Intel SPS Configuration (*E3C246D2I / E3C242D2I only*) / Server ME Configuration (*C246 WSI only*), Intel(R) Bios Guard Technology and Instant Flash.

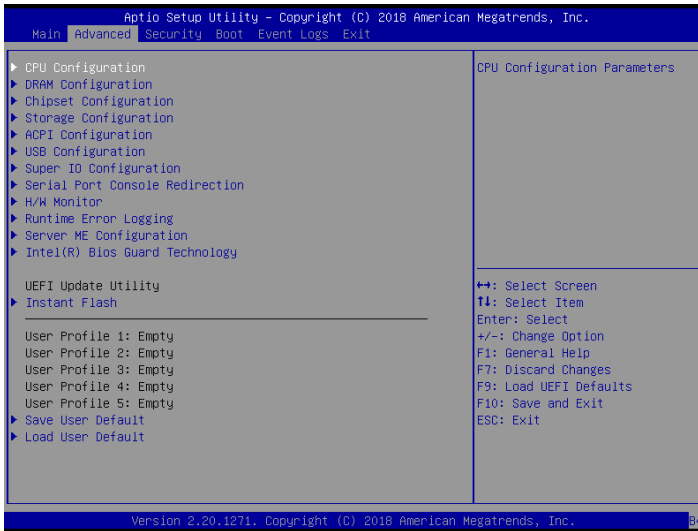

#### Save User Default

Type a profile name and press enter to save your settings as user default.

#### Load User Default

Load previously saved user defaults.



*Setting wrong values in this section may cause the system to malfunction.*

### 3.3.1 CPU Configuration

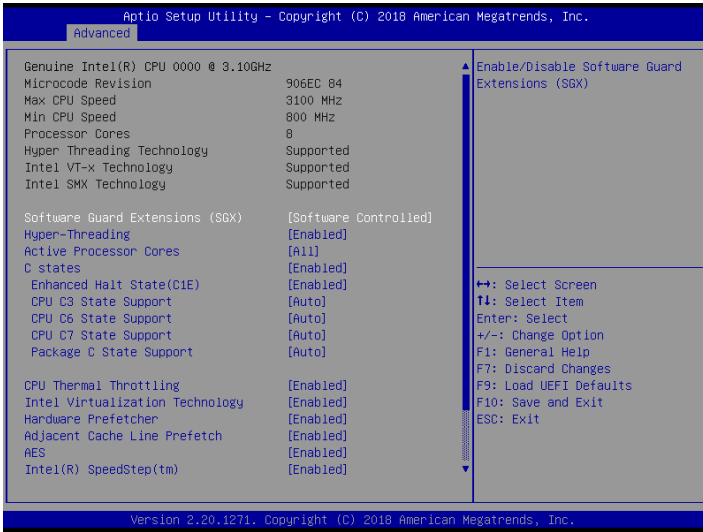

#### Software Guard Extensions (SGX)

Use this item to enable or disable Software Controlled Software Guard Extensions (SGX).

#### Hyper Threading *(Supported depending on your CPU)*

Intel Hyper Threading Technology allows multiple threads to run on each core, so that the overall performance on threaded software is improved.

#### Active Processor Cores

Select the number of cores to enable in each processor package.

#### C States *(C246 WSI) / CPU C States Support (E3C246D21/ E3C242D21)*

Enable CPU C States Support for power saving. It is recommended to keep C3, C6 and C7 all enabled for better power saving.

#### Enhanced Halt State (C1E)

Enable Enhanced Halt State (C1E) for lower power consumption.

#### CPU C3 State Support

Enable C3 sleep state for lower power consumption.

## CPU C6 State Support

Enable C6 deep sleep state for lower power consumption.

## CPU C7 State Support

Enable C7 deep sleep state for lower power consumption.

## Package C State Support

Enable CPU, PCIe, Memory, Graphics C State Support for power saving.

## CPU Thermal Throttling *(C246 WSI only)*

Enable CPU internal thermal control mechanisms to keep the CPU from overheating.

## Intel Virtualization Technology

Intel Virtualization Technology allows a platform to run multiple operating systems and applications in independent partitions, so that one computer system can function as multiple virtual systems.

### VT-d *(E3C246D2I / E3C242D2I)*

Intel® Virtualization Technology for Directed I/O helps your virtual machine monitor better utilize hardware by improving application compatibility and reliability, and providing additional levels of manageability, security, isolation, and I/O performance.

## Hardware Prefetcher

Automatically prefetch data and code for the processor. Enable for better performance.

## Adjacent Cache Line Prefetch

Automatically prefetch the subsequent cache line while retrieving the currently requested cache line. Enable for better performance.

## CPU AES

Use this to enable or disable CPU Advanced Encryption Standard instructions.

## Intel SpeedStep(tm) *(C246 WSI only)* / Intel SpeedStep Technology *(E3C246D2I / E3C242D2I)*

Intel SpeedStep technology is Intel's new power saving technology. Processors can switch between multiple frequencies and voltage points to enable power saving. The default value is [Enabled]. Configuration options: [Enabled] and [Disabled]. This item will be hidden if the current CPU does not support Intel SpeedStep technology.



Please note that enabling this function may reduce CPU voltage and lead to system stability or compatibility issues with some power supplies. Please set this item to [Disabled] if above issues occur.

## Turbo Mode *(C246 WSI only)*

Use this item to enable or disable Intel Turbo Boost Mode Technology. Turbo Boost Mode allows processor cores to run faster than marked frequency in specific conditions. The default value is [Enabled].

## Enable Intel TXT Support

Use this to enable or disable Intel Trusted Execution Technology.

## Long Duration Power Limit

Configure Package Power Limit 1 in watts. When the limit is exceeded, the CPU ratio will be lowered after a period of time. A lower limit can protect the CPU and save power, while a higher limit may improve performance.

## Long Duration Maintained

Configure the period of time until the CPU ratio is lowered when the Long Duration Power Limit is exceeded.

## Short Duration Power Limit

Configure Package Power Limit 2 in watts. When the limit is exceeded, the CPU ratio will be lowered immediately. A lower limit can protect the CPU and save power, while a higher limit may improve performance.

## CPU Thermal Throttling *(E3C246D21 / E3C242D21 only)*

Enable CPU internal thermal control mechanisms to keep the CPU from overheating.

### 3.3.2 DRAM Configuration

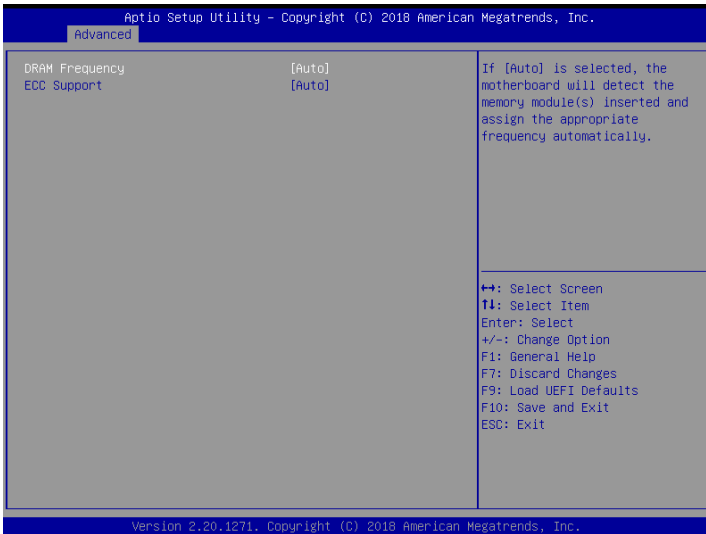

#### DRAM Frequency

If [Auto] is selected, the motherboard will detect the memory module(s) inserted and assign the appropriate frequency automatically.

#### ECC Support *(C246 WSI only)*

Use this item to enable or disable DDR ECC Support.

### 3.3.3 Chipset Configuration

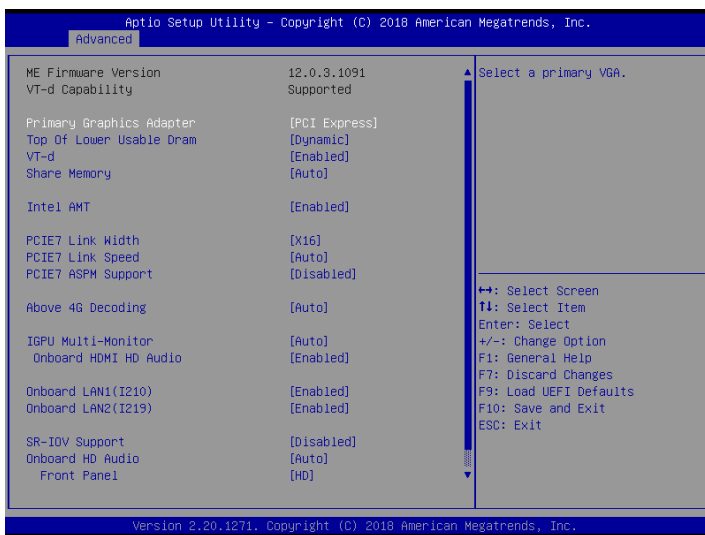

#### Primary Graphics Adapter

If PCI Express graphics card is installed on the motherboard, you may use this option to select PCI Express or Onboard as the primary graphics adapter.

#### Onboard VGA *(E3C246D2I / E3C242D2I only)*

Use this to enable or disable the Onboard VGA function. The default value is [Auto].

#### Onboard LAN1 *(E3C246D2I / E3C242D2I only)*

Use this to enable or disable the Onboard LAN1 function. The default value is [Auto].

#### Onboard LAN2 *(E3C246D2I / E3C242D2I only)*

Use this to enable or disable the Onboard LAN2 function. The default value is [Auto].

#### Top of Lower Usable Dram *(C246 WSI only)*

Maximum Value of TOLUD. Dynamic assignment would adjust TOLUD automatically based on largest MMIO length of installed graphic controller.

#### VT-d *(C246 WSI only)*

Intel Virtualization Technology for Directed I/O helps your virtual machine monitor better utilize hardware by improving application compatibility and reliability, and providing additional levels of manageability, security, isolation, and I/O performance.



**Share Memory** *(C246 WSI only)*

Configure the size of memory that is allocated to the integrated graphics processor when the system boots up.

**Intel AMT** *(C246 WSI only)*

Use this option to enable or disable Intel(R) Active Management Technology BIOS Extension. Please be noted that the iAMT H/W is always enabled. This option just controls the BIOS extension execution. If enabled, this requires additional firmware in the SPI device.

**Above 4G Decoding** *(E3C246D2I / E3C242D2I only)*

Enable or disable 64bit capable Devices to be decoded in Above 4G Address Space (only if the system supports 64 bit PCI decoding).

**PCIe 7 Link Width**

This allows you to select PCIe 7 Link Width. The default value is [x16].

**PCIe 7 Link Speed**

This allows you to select PCIe 7 Link Speed. The default value is [Auto].

**PCIe7 ASPM Support**

This option enables or disables the ASPM support for PCIe7.

**OCULINK Speed** *(E3C246D2I / E3C242D2I only)*

This allows you to select OCULINK Link Speed. The default value is [Auto].

**OCULINK ASPM Support** *(E3C246D2I / E3C242D2I only)*

This option enables or disables the ASPM support for OCULINK.

**Above 4G Decoding** *(C246 WSI only)*

Enable or disable 64bit capable Devices to be decoded in Above 4G Address Space (only if the system supports 64 bit PCI decoding).

**IGPU Multi-Monitor** *(C246 WSI only)*

Select disable to disable the integrated graphics when an external graphics card is installed. Select enable to keep the integrated graphics enabled at all times.

**Onboard HDMI HD Audio** *(C246 WSI only)*

This allows you to enable or disable the Onboard HDMI HD Audio feature.

**Onboard LAN1 (I210)** *(C246 WSI only)*

This tem allows you to enable or disable the Onboard LAN 1 feature.

### **Onboard LAN2 (I219)** *(C246 WSI only)*

This allows you to enable or disable the Onboard LAN 2 feature.

### **SR-IOV Support**

If system has SR-IOV capable PCIe Devices, this option Enables or Disables Single Root IO Virtualization Support.

### **Onboard HD Audio** *(C246 WSI only)*

Enable/disable onboard HD audio. Set to Auto to enable onboard HD audio and automatically disable it when a sound card is installed.

### **Front Panel** *(C246 WSI only)*

Enable/disable front panel HD audio.

### **Restore on AC/Power Loss**

This allows you to set the power state after an unexpected AC/power loss. If [Power Off] is selected, the AC/power remains off when the power recovers. If [Power On] is selected, the AC/power resumes and the system starts to boot up when the power recovers. If [Last State] is selected, it will recover to the state before AC/power loss.

### 3.3.4 Storage Configuration

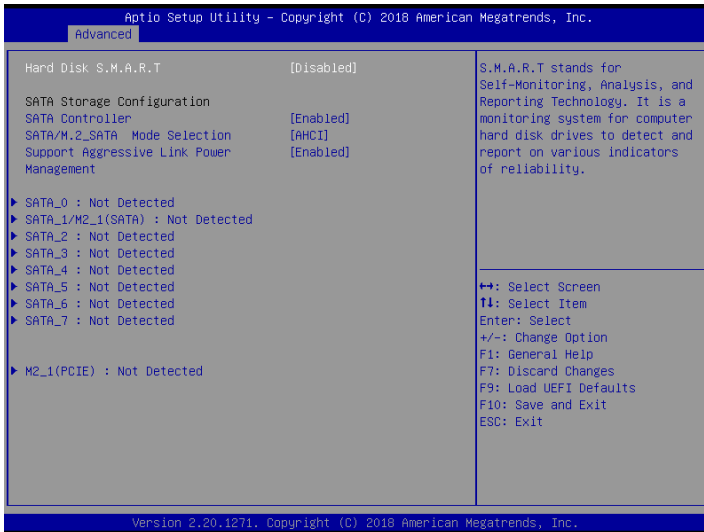

#### Hard Disk S.M.A.R.T.

S.M.A.R.T. stands for Self-Monitoring, Analysis, and Reporting Technology. It is a monitoring system for computer hard disk drives to detect and report on various indicators or reliability.

#### SATA Controller

Use this item to enable or disable SATA Controllers.

#### SATA/M.2\_SATA Mode Selection

Identify the SATA/M.2\_SATA port is connected to Solid State Drive or Hard Disk Drive. Press <Ctrl+I> to enter RAID ROM during UEFI POST process.

#### Support Aggressive Link Power Management

Use this item to enable or disable SALP.

## 3.3.5 ACPI Configuration

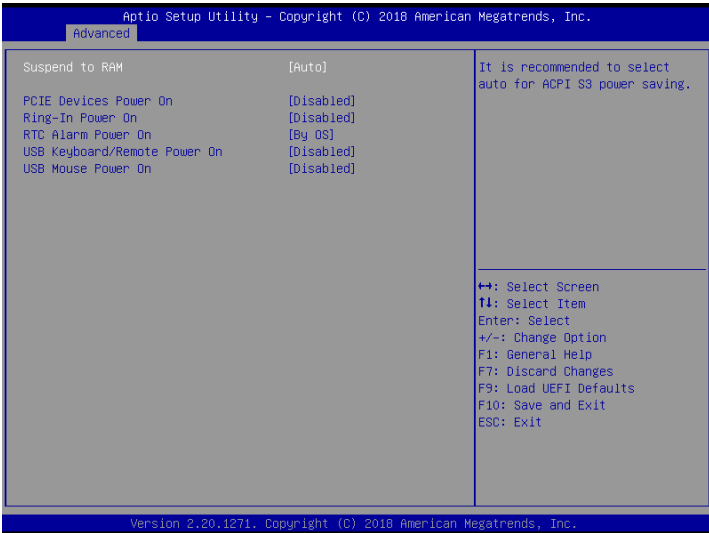

### Suspend to RAM *(C246 WSI only)*

Select disable for ACPI suspend type S1. It is recommended to select auto for ACPI S3 power saving.

### PCIE Devices Power On

Use this item to enable or disable PCIE devices to turn on the system from the power-soft-off mode.

### Ring-In Power On

Use this item to enable or disable Ring-In signals to turn on the system from the power-soft-off mode.

### RTC Alarm Power On

Use this item to enable or disable RTC (Real Time Clock) to power on the system.

### USB Keyboard/Remote Power On *(C246 WSI only)*

Allow the system to be waked up by an USB keyboard or remote controller.

### USB Mouse Power On *(C246 WSI only)*

Allow the system to be waked up by an USB mouse.

### 3.3.6 USB Configuration



#### Legacy USB Support

Use this option to enable or disable legacy support for USB devices. The default value is [Enabled].

## 3.3.7 Super IO Configuration

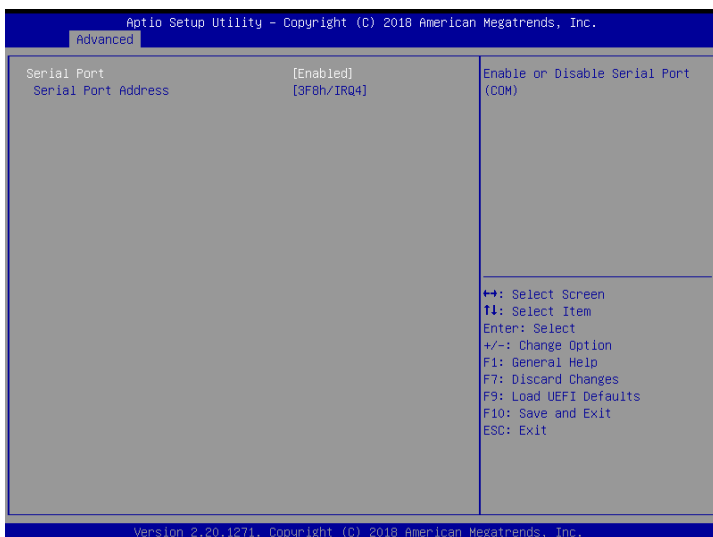

(C246 WSI)

### Serial Port

Use this item to enable or disable the onboard serial port.

### Serial Port Address

Use this item to select an optimal setting for Super IO device.

(E3C246D2I / E3C242D2I only)

### Serial Port 1 Configuration

Use this item to set parameters of Serial Port 1 (COM1).

### Serial Port

Use this item to enable or disable the onboard serial port.

### Change Settings

Use this item to select an optimal setting for Super IO device.

### SOL Port Configuration

Use this item to set parameters of SOL.

## SOL Port Configuration

Use this item to enable or disable Serial Port (SOL).

## SOL Port Address

Use this item to select an optimal setting for Super IO device.

### 3.3.8 Serial Port Console Redirection

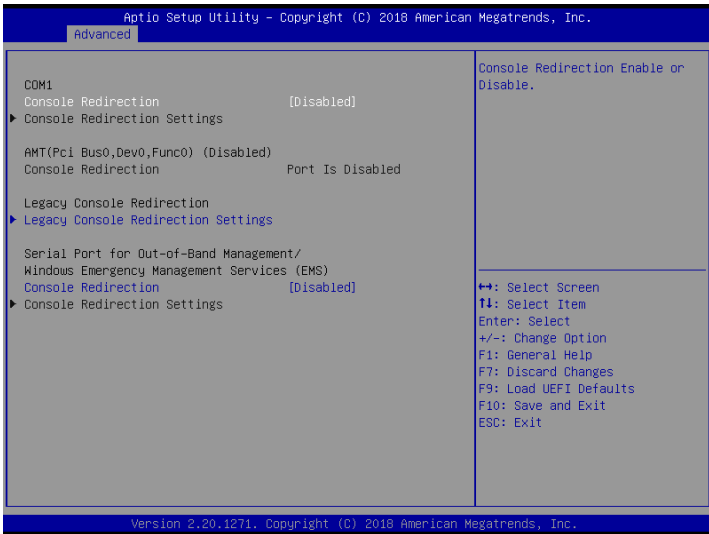

COM1 / SOL *(E3C246D21 / E3C242D21 only)*

#### Console Redirection

Use this option to enable or disable Console Redirection. If this item is set to Enabled, you can select a COM Port to be used for Console Redirection.

#### Console Redirection Settings

Use this option to configure Console Redirection Settings, and specify how your computer and the host computer to which you are connected exchange information.

#### Terminal Type

Use this item to select the preferred terminal emulation type for out-of-band management. It is recommended to select [VT-UTF8].

Option	Description
VT100	ASCII character set
VT100+	Extended VT100 that supports color and function keys
VT-UTF8	UTF8 encoding is used to map Unicode chars onto 1 or more bytes
ANSI	Extended ASCII character set



**Bits Per Second**

Use this item to select the serial port transmission speed. The speed used in the host computer and the client computer must be the same. Long or noisy lines may require lower transmission speed. The options include [9600], [19200], [57600] and [115200].

**Data Bits**

Use this item to set the data transmission size. The options include [7] and [8] (Bits).

**Parity**

Use this item to select the parity bit. The options include [None], [Even], [Odd], [Mark] and [Space].

**Stop Bits**

The item indicates the end of a serial data packet. The standard setting is [1] Stop Bit. Select [2] Stop Bits for slower devices.

**Flow Control**

Use this item to set the flow control to prevent data loss from buffer overflow. When sending data, if the receiving buffers are full, a "stop" signal can be sent to stop the data flow. Once the buffers are empty, a "start" signal can be sent to restart the flow. Hardware flow uses two wires to send start/stop signals. The options include [None] and [Hardware RTS/CTS].

**VT-UTF8 Combo Key Support**

Use this item to enable or disable the VT-UTF8 Combo Key Support for ANSI/VT100 terminals.

**Recorder Mode**

Use this item to enable or disable Recorder Mode to capture terminal data and send it as text messages.

**Resolution 100x31**

Use this item to enable or disable extended terminal resolution support.

**Legacy OS Redirection Resolution**

Use this item to select the number of rows and columns used in legacy OS redirection.

**Putty Keypad**

Use this item to select Function Key and Keypad on Putty.

**Redirection After BIOS POST**

If the [LoadBooster] is selected, legacy console redirection is disabled before booting to legacy OS. If [Always Enabled] is selected, legacy console redirection is enabled for legacy OS. The default value is [Always Enabled].

## Legacy Console Redirection

### Legacy Console Redirection Settings

Use this option to configure Legacy Console Redirection Settings, and specify how your computer and the host computer to which you are connected exchange information.

#### Redirection COM Port

Select a COM port to display redirection of Legacy OS and Legacy OPROM Messages.

#### Resolution

On Legacy OS, the Number of Rows and Columns supported redirection.

#### Redirect After POST

When Bootloader is selected, then Legacy Console Redirection is disabled before booting to legacy OS. When Always Enable is selected, then Legacy Console Redirection is enabled for legacy OS. Default setting for this option is set to Always Enable.

### Serial Port for Out-of-Band Management/Windows Emergency Management Services (EMS)

#### Console Redirection

Use this option to enable or disable Console Redirection. If this item is set to Enabled, you can select a COM Port to be used for Console Redirection.

### Console Redirection Settings

Use this option to configure Console Redirection Settings, and specify how your computer and the host computer to which you are connected exchange information.

#### Terminal Type

Use this item to select the preferred terminal emulation type for out-of-band management. It is recommended to select [VT-UTF8].

Option	Description
VT100	ASCII character set
VT100+	Extended VT100 that supports color and function keys
VT-UTF8	UTF8 encoding is used to map Unicode chars onto 1 or more bytes
ANSI	Extended ASCII character set

#### Bits Per Second

Use this item to select the serial port transmission speed. The speed used in the host computer and the client computer must be the same. Long or noisy lines may require lower transmission speed. The options include [9600], [19200], [57600] and [115200].

**Flow Control**

Use this item to set the flow control to prevent data loss from buffer overflow. When sending data, if the receiving buffers are full, a "stop" signal can be sent to stop the data flow. Once the buffers are empty, a "start" signal can be sent to restart the flow. Hardware flow uses two wires to send start/stop signals. The options include [None], [Hardware RTS/CTS], and [Software Xon/Xoff].

**Data Bits****Parity****Stop Bits**

### 3.3.9 H/W Monitor

In this section, it allows you to monitor the status of the hardware on your system, including the parameters of the CPU temperature, motherboard temperature, CPU fan speed, chassis fan speed, and the critical voltage.

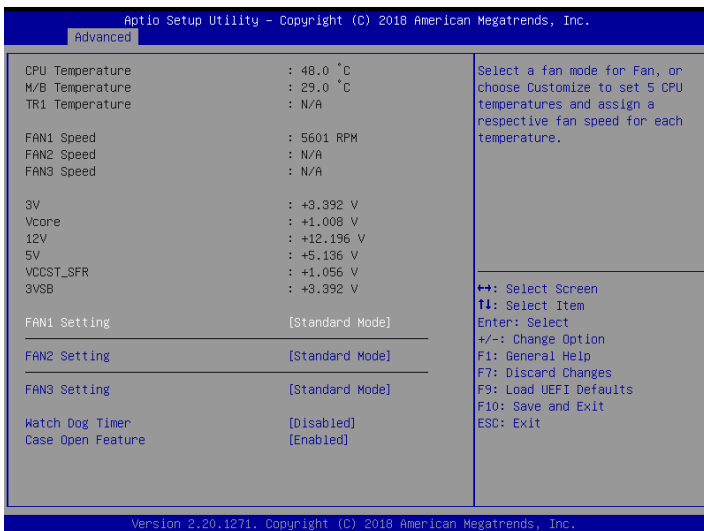

(C246 WSI)

#### FAN1 Setting

Select a fan mode for FAN, or choose Customize to set 5 CPU temperatures and assign a respective fan speed for each temperature.

#### FAN2 Setting

Select a fan mode for FAN, or choose Customize to set 5 CPU temperatures and assign a respective fan speed for each temperature.

#### FAN3 Setting

Select a fan mode for FAN, or choose Customize to set 5 CPU temperatures and assign a respective fan speed for each temperature.

#### Watch Dog Timer

This allows you to enable or disable the Watch Dog Timer. The default value is [Disabled].

#### Case Open Feature

Enable or disable Case Open Feature to detect whether the chassis cover has been removed.

*(E3C246D2I / E3C242D2I only)*

## FAN Control

If [Auto] is selected, the fan speed will controlled by BMC.

If [Manual] is selected, configure the items below.

### CPU\_FAN1

This allows you to set the CPU fan1's speed. The default value is [Smart Fan].

### REAR\_FAN1

This allows you to set the rear fan 1's speed. The default value is [Smart Fan].

### FRNT\_FAN1

This allows you to set the front fan 1's speed. The default value is [Smart Fan].

## Smart Fan Control

This allows you to set the Smart fan's level speed.

### Smart Fan Duty Control

Smart Fan Duty x (x means 1 to 11 stage)

This allows you to set duty cycle for each stage.

### Smart Fan Temp Control

Smart Fan Temp x (x means 1 to 11 stage)

This allows you to set temperature for each stage.

## 3.3.10 Runtime Error Logging

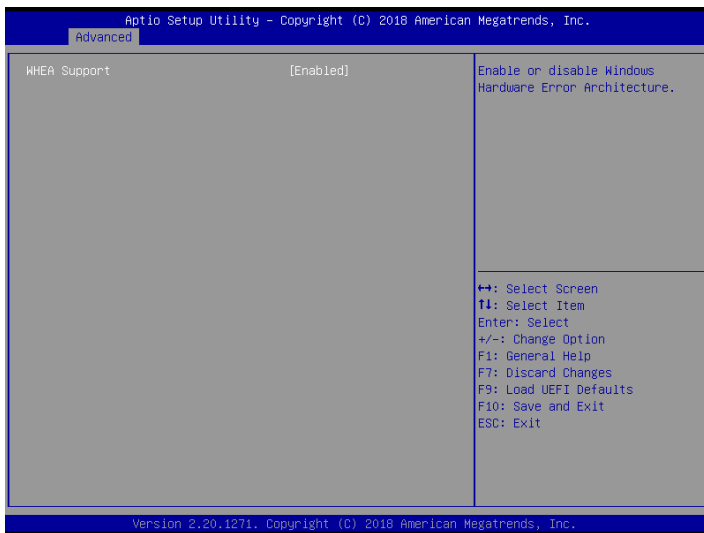

*C246 WSI only:*

### WHEA Support

Use this item to enable or disable Windows Hardware Error Architecture.

*E3C246D21 / E3C242D21 only:*

### Runtime Error Logging System Enabling

Use this item to enable or disable Runtime Error Logging System.

### Memory Error Enabling

Memory enabling and logging setup option.

### PCI/PCI Error Enabling

Use this item to enable or disable PCI errors.

### Corrected Error Enable

Use this item to enable or disable Correctable errors.

### Uncorrected Error Enable

Use this item to enable or disable Uncorrectable errors.

## Fatal Error Enable

Use this item to enable or disable Fatal errors.

### 3.3.11 Intel SPS Configuration *(E3C246D21 / E3C242D21 only)* / Server ME Configuration *(C246 WSI only)*

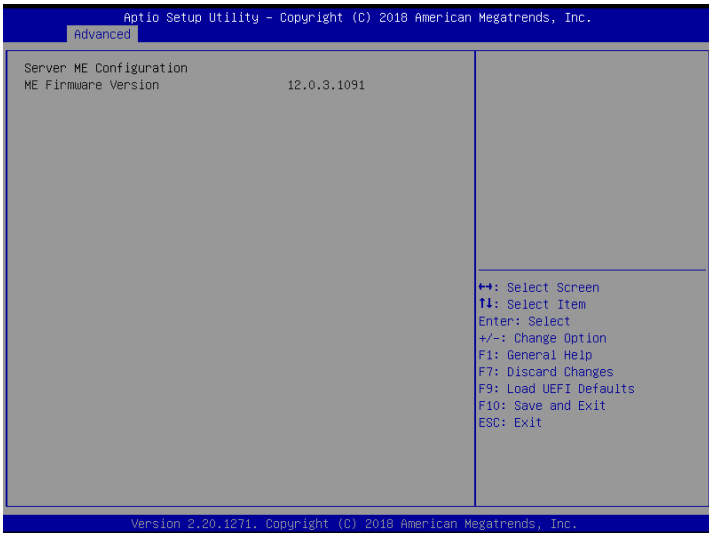

SPS screen displays the Intel SPS Configuration information, such as Operational Firmware Version and Firmware State.



### 3.3.12 Intel(R) Bios Guard Technology



#### Intel Bios Guard Support

Use this to enable or disable Intel Bios Guard Support. The default value is [Disabled].

### 3.3.13 Instant Flash

Instant Flash is a UEFI flash utility embedded in Flash ROM. This convenient UEFI update tool allows you to update system UEFI without entering operating systems first like MS-DOS or Windows. Just save the new UEFI file to your USB flash drive, floppy disk or hard drive and launch this tool, then you can update your UEFI only in a few clicks without preparing an additional floppy diskette or other complicated flash utility. Please be noted that the USB flash drive or hard drive must use FAT32/16/12 file system. If you execute Instant Flash utility, the utility will show the UEFI files and their respective information. Select the proper UEFI file to update your UEFI, and reboot your system after the UEFI update process is completed.

### 3.4 Server Mgmt *(E3C246D2I / E3C242D2I only)*

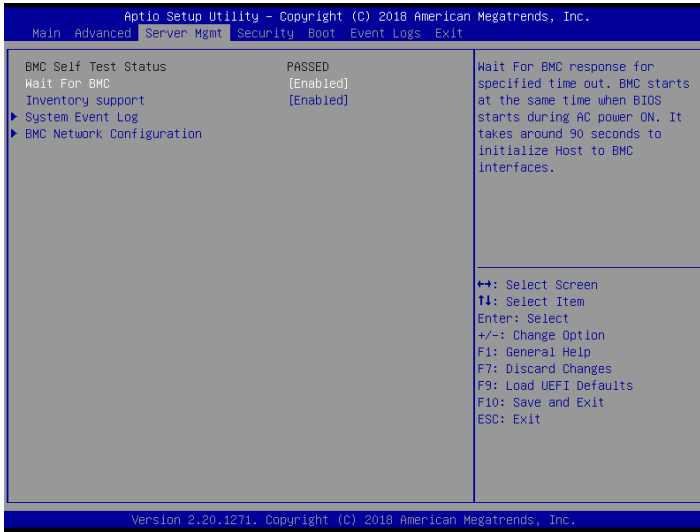

#### Wait For BMC

Wait For BMC response for specified time out. BMC starts at the same time when BIOS starts during AC power ON. It takes around 90 seconds to initialize Host to BMC interfaces.

#### Inventory Support

This will execute inventory function for system. Enabling this item will take some time at system boot.

## 3.4.1 System Event Log

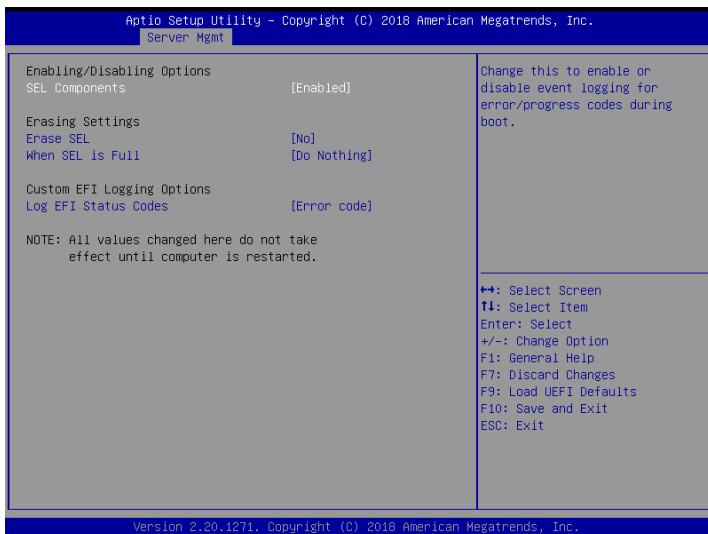

### SEL Components

Change this to enable or disable event logging for error/progress codes during boot.

### Erase SEL

Use this to choose options for erasing SEL.

### When SEL is Full

Use this to choose options for reactions to a full SEL.

### Log EFI Status Codes

Use this item to disable the logging of EFI Status Codes or log only error code or only progress code or both.

## 3.4.2 BMC Network Configuration

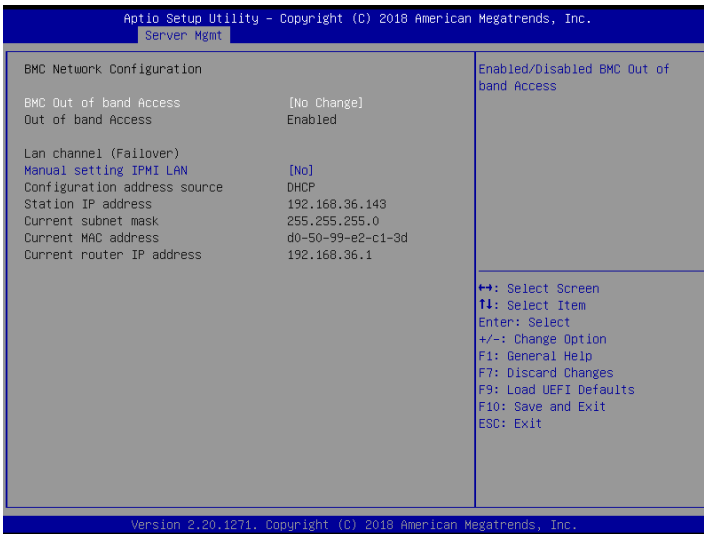

### Lan Channel (Failover)

#### Manual Setting IPMI LAN

If [No] is selected, the IP address is assigned by DHCP. If you prefer using a static IP address, toggle to [Yes], and the changes take effect after the system reboots. The default value is [No].

#### Configuration Address Source

Select to configure BMC network parameters statically or dynamically (by BIOS or BMC). Configuration options: [Static] and [DHCP].

**Static:** Manually enter the IP Address, Subnet Mask and Gateway Address in the BIOS for BMC LAN channel configuration.

**DHCP:** IP address, Subnet Mask and Gateway Address are automatically assigned by the network's DHCP server.



When [DHCP] or [Static] is selected, do NOT modify the BMC network settings on the IPMI web page.



*The default login information for the IPMI web interface is:*

*Username: admin*

*Password: admin*

*For more instructions on how to set up remote control environment and use the IPMI management platform, please refer to the IPMI Configuration User Guide or go to the Support website at: <http://www.asrockrack.com/support/faq.asp>*

## 3.5 Security

In this section, you may set or change the supervisor/user password for the system. For the user password, you may also clear it.

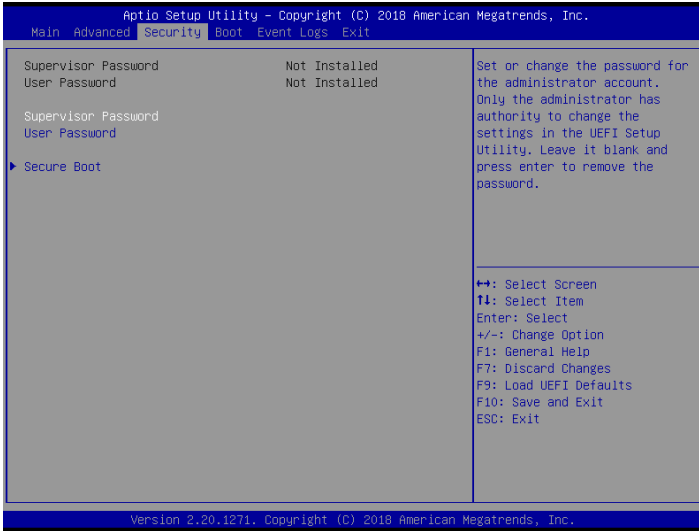

### Supervisor Password

Set or change the password for the administrator account. Only the administrator has authority to change the settings in the UEFI Setup Utility. Leave it blank and press enter to remove the password.

### User Password

Set or change the password for the user account. Users are unable to change the settings in the UEFI Setup Utility. Leave it blank and press enter to remove the password.

### Secure Boot

Use this to enable or disable Secure Boot Control. The default value is [Disabled]. Enable to support Windows Server 2012 R2 or later versions Secure Boot.

### Secure Boot Mode

Secure Boot mode selector: Standard/Custom. In Custom mode, Secure Boot Policy variables can be configured by a physically present user without full authentication.

## 3.5.1 Key Management

In this section, expert users can modify Secure Boot Policy variables without full authentication.

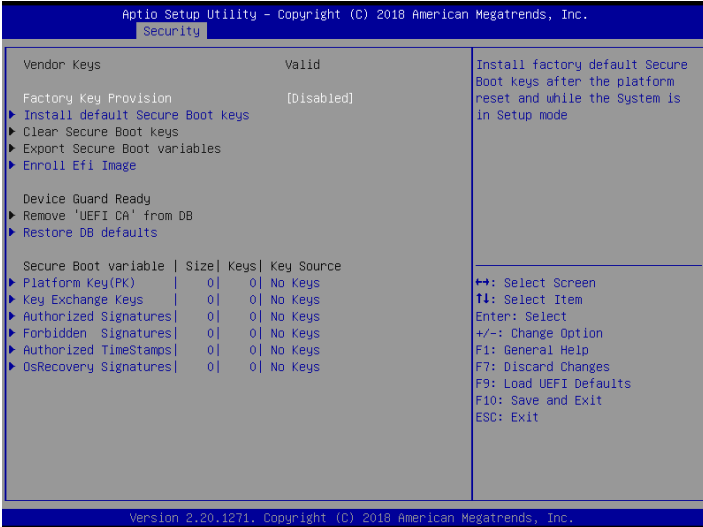

### Factory Key Provision

Install factory default Secure Boot keys after the platform reset and while the System is in Setup mode.

### Clear Secure Boot keys

Force System to Setup Mode - clear all Secure Boot Variables. Change takes effect after reboot.

### Export Secure Boot variables

Copy NVRAM content of Secure Boot variables to files in a root folder on a file system device.

### Enroll Efi Image

Allow the image to run in Secure Boot mode. Enroll SHA256 Hash certificate of a PE image into Authorized Signature Database (db).

### Remove 'UEFI CA' from DB

Device Guard ready system must not list 'Microsoft UEFI CA' Certificate in Autho



rized Signature database (db).

## Restore DB defaults

Restore DB variable to factory defaults.

## Platform Key(PK)

Enroll Factory Defaults or load certificates from a file:

1. Public Key Certificate in:
  - a) EFI\_SIGNATURE\_LIST
  - b) EFI\_CERT\_X509 (DER)
  - c) EFI\_CERT\_RSA2048 (bin)
  - d) EFI\_CERT\_SHA256, 384, 512
2. Authenticated UEFI Variable
3. EFI PE/COFF Image(SHA256)

Key Source: Factory, External, Mixed

## Key Exchange Keys

Enroll Factory Defaults or load certificates from a file:

1. Public Key Certificate in:
  - a) EFI\_SIGNATURE\_LIST
  - b) EFI\_CERT\_X509 (DER encoded)
  - c) EFI\_CERT\_RSA2048 (bin)
  - d) EFI\_CERT\_SHA256, 384, 512
2. Authenticated UEFI Variable
3. EFI PE/COFF Image(SHA256)

Key Source: Factory, External, Mixed

## Authorized Signatures

Enroll Factory Defaults or load certificates from a file:

1. Public Key Certificate in:
  - a) EFI\_SIGNATURE\_LIST

b) EFI\_CERT\_X509 (DER encoded)

c) EFI\_CERT\_RSA2048 (bin)

d) EFI\_CERT\_SHA256, 384, 512

2. Authenticated UEFI Variable

3. EFI PE/COFF Image(SHA256)

Key Source: Factory, External, Mixed

## Forbidden Signatures

Enroll Factory Defaults or load certificates from a file:

1. Public Key Certificate in:

a) EFI\_SIGNATURE\_LIST

b) EFI\_CERT\_X509 (DER encoded)

c) EFI\_CERT\_RSA2048 (bin)

d) EFI\_CERT\_SHA256, 384, 512

2. Authenticated UEFI Variable

3. EFI PE/COFF Image(SHA256)

Key Source: Factory, External, Mixed

## Authorized TimeStamps

Enroll Factory Defaults or load certificates from a file:

1. Public Key Certificate in:

a) EFI\_SIGNATURE\_LIST

b) EFI\_CERT\_X509 (DER encoded)

c) EFI\_CERT\_RSA2048 (bin)

d) EFI\_CERT\_SHA256, 384, 512

2. Authenticated UEFI Variable

3. EFI PE/COFF Image(SHA256)

Key Source: Factory, External, Mixed

## OsRecovery Signatures

Enroll Factory Defaults or load certificates from a file:

1. Public Key Certificate in:

- a) EFI\_SIGNATURE\_LIST
- b) EFI\_CERT\_X509 (DER encoded)
- c) EFI\_CERT\_RSA2048 (bin)
- d) EFI\_CERT\_SHA256, 384, 512

2. Authenticated UEFI Variable

3. EFI PE/COFF Image(SHA256)

Key Source: Default, External, Mixed, Test

## 3.6 Boot Screen

In this section, it will display the available devices on your system for you to configure the boot settings and the boot priority.

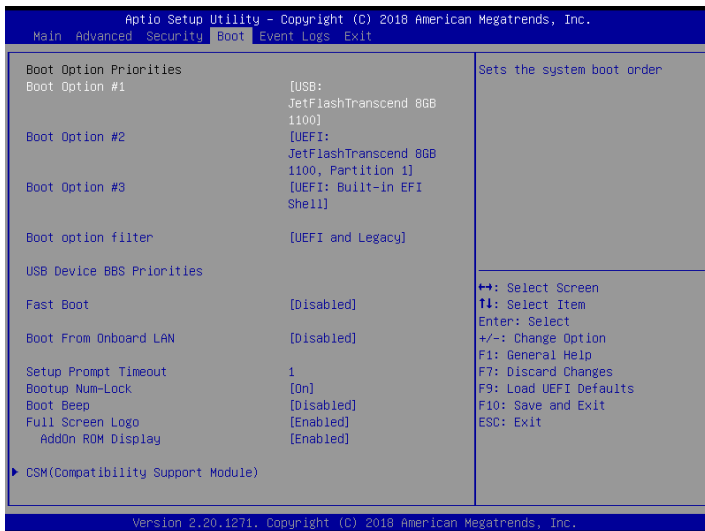

### Boot Option #1

Use this item to set the system boot order.

### Boot Option #2

Use this item to set the system boot order.

### Boot Option #3

Use this item to set the system boot order.

### Boot Option Filter

This option controls Legacy/UEFI ROMs priority.

### USB Device BBS Priorities

This page will show only when system install USB Storage.

### Fast Boot *(C246 WSI only)*

Fast Boot minimizes your computer's boot time. In fast mode you may not boot from an USB storage device. Ultra Fast mode is only supported by Windows 8.1 and the VBIOS must support UEFI GOP if you are using an external graphics card.

Please notice that Ultra Fast mode will boot so fast that the only way to enter this UEFI Setup Utility is to Clear CMOS or run the Restart to UEFI utility in Windows.

## Boot From Onboard LAN

Use this item to enable or disable the Boot From Onboard LAN feature.

## Setup Prompt Timeout

This shows the number of seconds to wait for setup activation key. 65535(0XFFFF) means indefinite waiting.

## Bootup Num-Lock

If this item is set to [On], it will automatically activate the Numeric Lock function after boot-up.

## Boot Beep

Select whether the Boot Beep should be turned on or off when the system boots up. Please note that a buzzer is needed.

## Full Screen Logo

Use this item to enable or disable OEM Logo. The default value is [Enabled].

## AddOn ROM Display

Use this option to adjust AddOn ROM Display. If you enable the option "Full Screen Logo" but you want to see the AddOn ROM information when the system boots, please select [Enabled]. Configuration options: [Enabled] and [Disabled]. The default value is [Enabled].

## Boot Failure Guard Message (C246 WSI only)

If the computer fails to boot for a number of times the system automatically restores the default settings.

## 3.6.1 CSM Parameters

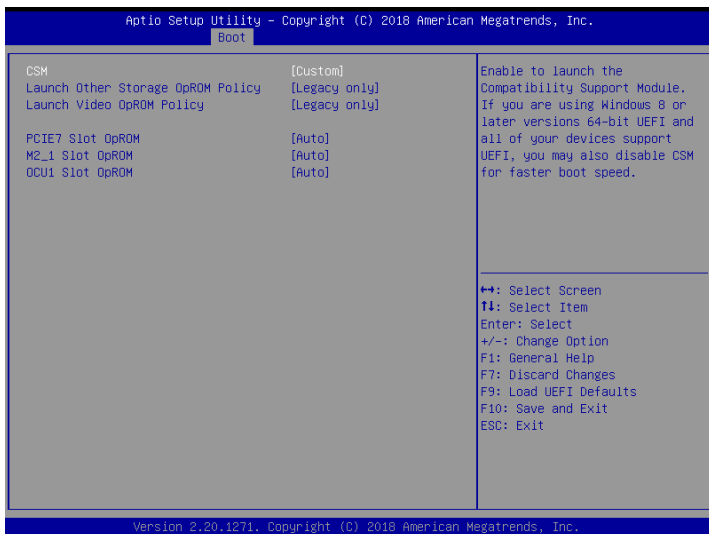

### CSM

Enable to launch the Compatibility Support Module. Please do not disable unless you're running a WHCK test. If you are using Windows 8.1 64-bit and all of your devices support UEFI, you may also disable CSM for faster boot speed.

### Launch Other Storage OpROM Policy

Select UEFI only to run those that support UEFI option ROM only. Select Legacy only to run those that support legacy option ROM only. Select Do not launch to not execute both legacy and UEFI option ROM.

### Launch Video OpROM Policy

Select UEFI only to run those that support UEFI option ROM only. Select Legacy only to run those that support legacy option ROM only. Select Do not launch to not execute both legacy and UEFI option ROM.

### PCIe7 Slot OpROM

This option controls Legacy/UEFI ROMs priority.

### M2\_1 Slot OpROM

This option controls Legacy/UEFI ROMs priority.

## OCU1 Slot OpROM

This option controls Legacy/UEFI ROMs priority.

## 3.7 Event Logs

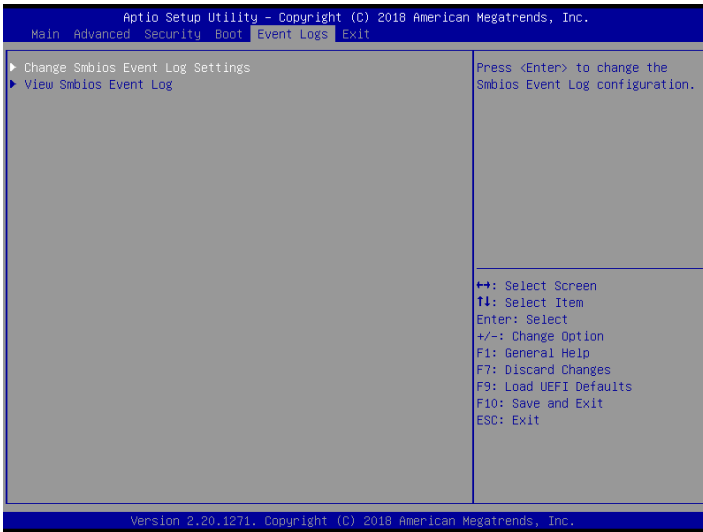

### Change Smbios Event Log Settings

This allows you to configure the Smbios Event Log Settings.

When entering the item, you will see the followings:

#### **Smbios Event Log**

Use this item to enable or disable all features of the SMBIOS Event Logging during system boot.

#### **Erase Event Log**

The options include [No], [Yes, Next reset] and [Yes, Every reset]. If Yes is selected, all logged events will be erased.

#### **When Log is Full**

Use this item to choose options for reactions to a full Smbios Event Log. The options include [Do Nothing] and [Erase Immediately].

#### **Log System Boot Event**

Choose option to enable/disable logging of System boot event.

#### **View Smbios Event Log**

Press <Enter> to view the Smbios Event Log records.



*All values changed here do not take effect until computer is restarted.*



## 3.8 Exit Screen

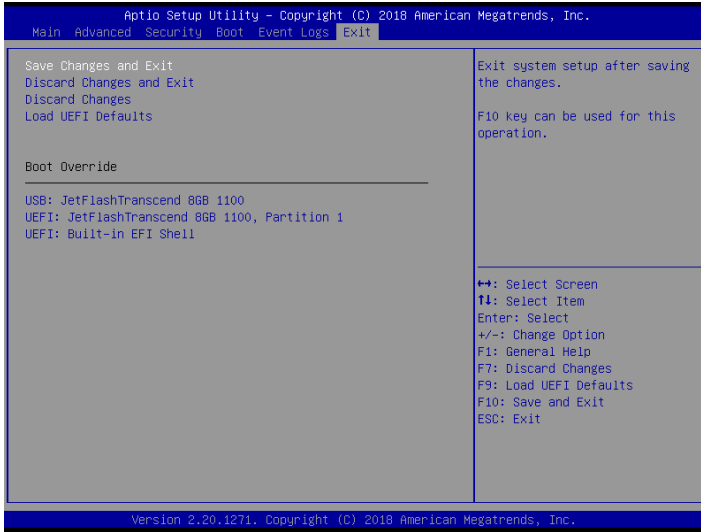

### Save Changes and Exit

When you select this option, the following message “Save configuration changes and exit setup?” will pop-out. Press <F10> key or select [Yes] to save the changes and exit the UEFI SETUP UTILITY.

### Discard Changes and Exit

When you select this option, the following message “Discard changes and exit setup?” will pop-out. Press <ESC> key or select [Yes] to exit the UEFI SETUP UTILITY without saving any changes.

### Discard Changes

When you select this option, the following message “Discard changes?” will pop-out. Press <F7> key or select [Yes] to discard all changes.

### Load UEFI Defaults

Load UEFI default values for all the setup questions. F9 key can be used for this operation.

### Boot Override

These items displays the available devices. Select an item to start booting from the selected device.

# Chapter 4 Software Support

## 4.1 Install Operating System

This motherboard supports various Microsoft® Windows® / Linux compliant. Because motherboard settings and hardware options vary, use the setup procedures in this chapter for general reference only. Refer to your OS documentation for more information.

*\*Please download the Intel® SATA Floppy Image driver from the ASRock Rack's website ([www.asrockrack.com](http://www.asrockrack.com)) to your USB drive or simply install the SATA driver from the Support CD while installing OS in SATA RAID mode.*

## 4.2 Support CD Information

The Support CD that came with the motherboard contains necessary drivers and useful utilities that enhance the motherboard's features.

### 4.2.1 Running The Support CD

To begin using the support CD, insert the CD into your CD-ROM drive. The CD automatically displays the Main Menu if "AUTORUN" is enabled in your computer. If the Main Menu does not appear automatically, locate and double click on the file "ASRSetup.exe" from the root folder in the Support CD to display the menu.

### 4.2.2 Drivers Menu

The Drivers Menu shows the available device's drivers if the system detects installed devices. Please install the necessary drivers to activate the devices.

### 4.2.3 Utilities Menu

The Utilities Menu shows the application softwares that the motherboard supports. Click on a specific item then follow the installation wizard to install it.

### 4.2.4 Contact Information

If you need to contact ASRock Rack or want to know more about ASRock Rack, welcome to visit ASRock Rack's website at <http://www.ASRockRack.com>; or you may contact your dealer for further information.

# Chapter 5 Troubleshooting

## 5.1 Troubleshooting Procedures

Follow the procedures below to troubleshoot your system.



*Always unplug the power cord before adding, removing or changing any hardware components. Failure to do so may cause physical injuries to you and damages to motherboard components.*

1. Disconnect the power cable and check whether the PWR LED is off.
2. Unplug all cables, connectors and remove all add-on cards from the motherboard.  
Make sure that the jumpers are set to default settings.
3. Confirm that there are no short circuits between the motherboard and the chassis.
4. Install a CPU and fan on the motherboard, then connect the chassis speaker and power LED.

### **If there is no power...**

1. Confirm that there are no short circuits between the motherboard and the chassis.
2. Make sure that the jumpers are set to default settings.
3. Check the settings of the 115V/230V switch on the power supply.
4. Verify if the battery on the motherboard provides ~3VDC. Install a new battery if it does not.

### **If there is no video...**

1. Try replugging the monitor cables and power cord.
2. Check for memory errors.

### **If there are memory errors...**

1. Verify that the DIMM modules are properly seated in the slots.
2. Use recommended DDR4 ECC UDIMMs.
3. If you have installed more than one DIMM modules, they should be identical with the same brand, speed, size and chip-type.
4. Try inserting different DIMM modules into different slots to identify faulty ones.
5. Check the settings of the 115V/230V switch on the power supply.

---

### **Unable to save system setup configurations...**

1. Verify if the battery on the motherboard provides ~3VDC. Install a new battery if it does not.
2. Confirm whether your power supply provides adequate and stable power.

### **Other problems...**

1. Try searching keywords related to your problem on ASRock Rack's FAQ page:  
<http://www.asrockrack.com/support>

## 5.2 Technical Support Procedures

If you have tried the troubleshooting procedures mentioned above and the problems are still unsolved, please contact ASRock Rack's technical support with the following information:

1. Your contact information
2. Model name, BIOS version and problem type.
3. System configuration.
4. Problem description.

You may contact ASRock Rack's technical support at:

<http://www.asrockrack.com/support/tsd.asp>

## 5.3 Returning Merchandise for Service

For warranty service, the receipt or a copy of your invoice marked with the date of purchase is required. By calling your vendor or going to our RMA website (<http://event.asrockrack.com/tsd.asp>) you may obtain a Returned Merchandise Authorization (RMA) number.

The RMA number should be displayed on the outside of the shipping carton which is mailed prepaid or hand-carried when you return the motherboard to the manufacturer. Shipping and handling charges will be applied for all orders that must be mailed when service is complete.

This warranty does not cover damages incurred in shipping or from failure due to alteration, misuse, abuse or improper maintenance of products.

Contact your distributor first for any product related problems during the warranty period.