



OPEN Industry Standard, Flexible Architecture

GREEN Less Heat, Less Power Consumption

STABLE Robust Design, Quality Parts

Stable and
Reliable Solution

Server/Workstation
Motherboard

X570D4I-2T



User Manual

English

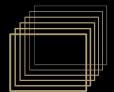

Version 1.0

Published September 2020

Copyright©2020 ASRock Rack Inc. All rights reserved.

Copyright Notice:

No part of this documentation may be reproduced, transcribed, transmitted, or translated in any language, in any form or by any means, except duplication of documentation by the purchaser for backup purpose, without written consent of ASRock Rack Inc.

Products and corporate names appearing in this documentation may or may not be registered trademarks or copyrights of their respective companies, and are used only for identification or explanation and to the owners' benefit, without intent to infringe.

Disclaimer:

Specifications and information contained in this documentation are furnished for informational use only and subject to change without notice, and should not be constructed as a commitment by ASRock Rack. ASRock Rack assumes no responsibility for any errors or omissions that may appear in this documentation.

With respect to the contents of this documentation, ASRock Rack does not provide warranty of any kind, either expressed or implied, including but not limited to the implied warranties or conditions of merchantability or fitness for a particular purpose.

In no event shall ASRock Rack, its directors, officers, employees, or agents be liable for any indirect, special, incidental, or consequential damages (including damages for loss of profits, loss of business, loss of data, interruption of business and the like), even if ASRock Rack has been advised of the possibility of such damages arising from any defect or error in the documentation or product.



This device complies with Part 15 of the FCC Rules. Operation is subject to the following two conditions:

- (1) this device may not cause harmful interference, and
- (2) this device must accept any interference received, including interference that may cause undesired operation.

CALIFORNIA, USA ONLY

The Lithium battery adopted on this motherboard contains Perchlorate, a toxic substance controlled in Perchlorate Best Management Practices (BMP) regulations passed by the California Legislature. When you discard the Lithium battery in California, USA, please follow the related regulations in advance.

“Perchlorate Material-special handling may apply, see www.dtsc.ca.gov/hazardouswaste/perchlorate”

ASRock Rack's Website: www.ASRockRack.com

Contact Information

If you need to contact ASRock Rack or want to know more about ASRock Rack, you're welcome to visit ASRock Rack's website at www.ASRockRack.com; or you may contact your dealer for further information.

ASRock Rack Incorporation

6F., No.37, Sec. 2, Jhongyang S. Rd., Beitou District,

Taipei City 112, Taiwan (R.O.C.)

Contents

Chapter 1 Introduction	1
1.1 Package Contents	1
1.2 Specifications	2
1.3 Unique Features	5
1.4 Motherboard Layout	6
1.5 Onboard LED Indicators	8
1.6 I/O Panel	9
1.7 Block Diagram	11
Chapter 2 Installation	12
2.1 Screw Holes	12
2.2 Pre-installation Precautions	12
2.3 Installing the CPU	13
2.4 Installing the CPU Fan and Heatsink	14
2.5 Installation of Memory Modules (DIMM)	15
2.6 Expansion Slot (PCI Express Slot)	17
2.7 Jumper Setup	18
2.8 Onboard Headers and Connectors	19
2.9 AC-IN / DC-IN Power Connections	24
2.10 Unit Identification purpose LED/Switch	25
2.11 Driver Installation Guide	25
2.12 Dual LAN and Teaming Operation Guide	26
2.13 M.2_SSD (NGFF) Module Installation Guide (M2_1)	27

Chapter 3 UEFI Setup Utility	28
3.1 Introduction	28
3.1.1 UEFI Menu Bar	28
3.1.2 Navigation Keys	29
3.2 Main Screen	30
3.3 Advanced Screen	31
3.3.1 CPU Configuration	32
3.3.2 Chipset Configuration	33
3.3.3 Storage Configuration	35
3.3.4 ACPI Configuration	36
3.3.5 USB Configuration	37
3.3.6 Super IO Configuration	38
3.3.7 Serial Port Console Redirection	39
3.3.8 H/W Monitor	42
3.3.9 Tls Auth Configuration	43
3.3.10 Network Stack Configuration	44
3.3.11 AMD CBS	46
3.3.12 AMD PBS	47
3.3.13 AMD Overclocking	50
3.3.14 RAM Disk Configuration	51
3.3.15 Instant Flash	52
3.4 Server Mgmt	53
3.4.1 System Event Log	54
3.4.2 BMC Network Configuration	55

3.4.3	BMC Tools	57
3.5	Security	58
3.5.1	Key Management	59
3.6	Boot Screen	63
3.6.1	CSM Parameters	65
3.7	Exit Screen	66
Chapter 4 Software Support		67
4.1	Install Operating System	67
4.2	Support CD Information	67
4.2.1	Running The Support CD	67
4.2.2	Drivers Menu	67
4.2.3	Utilities Menu	67
4.2.4	Contact Information	67
Chapter 5 Troubleshooting		68
5.1	Troubleshooting Procedures	68
5.2	Technical Support Procedures	70
5.3	Returning Merchandise for Service	70

Chapter 1 Introduction

Thank you for purchasing ASRock Rack X570D4I-2T motherboard, a reliable motherboard produced under ASRock Rack's consistently stringent quality control. It delivers excellent performance with robust design conforming to ASRock Rack's commitment to quality and endurance.



Because the motherboard specifications and the BIOS software might be updated, the content of this manual will be subject to change without notice. In case any modifications of this manual occur, the updated version will be available on ASRock Rack website without further notice. You may find the latest memory and CPU support lists on ASRock Rack website as well. ASRock Rack's Website: www.ASRockRack.com

*If you require technical support related to this motherboard, please visit our website for specific information about the model you are using.
<http://www.asrockrack.com/support/>*

1.1 Package Contents

- ASRock Rack X570D4I-2T Motherboard
(Mini ITX Form Factor: 6.7-in x 6.7-in, 17.02 cm x 17.02 cm)
- 1 x SATA Power Cable (80cm)
- 1 x ATX 4P to 24P Power Cable
- 1 x I/O Shield
- 1 x Screw for M.2 Socket
- 1 x Oculink to 4 SATA Cable (60cm)
- Quick Installation Guide



If any items are missing or appear damaged, contact your authorized dealer.

1.2 Specifications

X570D4I-2T	
MB Physical Status	
Form Factor	Mini ITX
Dimension	6.7" x 6.7" (17.02cm x17.02 cm)
Processor System	
CPU	AMD Ryzen™ 3 rd Generation Series Processors* <i>*We recommend using the CPU HS listed in the Cooler QVL section on our ASRock Rack website.</i> <i>*Only LGA115x CPU heatsink is supported.</i>
Chipset	AMD X570
System Memory	
Capacity	4 x DDR4 DIMM slots
Type	- Dual Channel memory technology, 2DPC - 4 x 260-pin DDR4 ECC/SO-DIMM slots <i>*Conditionally supports ECC error reporting function.</i>
DIMM Size Per DIMM	ECC/SO-DIMM: 32GB, 16GB, 8GB, 4GB
DIMM Frequency	ECC/SO-DIMM: 2933/2666/2400/2133/1866 MHz
Voltage	1.2V
Expansion Slot	
PCIe 4.0/3.0 x16	1 slot
Storage	
SATA Controller	AMD X570: 2x OCULINK (support 4x SATA or PCIe4 from OCU1, 4x SATA or PCIe4 from OCU2)
M.2	1 M.2 M-key(NGFF 2280) (1 SATA 6Gb/s or PCIe4.0/3.0 x4)
Ethernet	
Interface	10000/1000 /100 Mbps
LAN	- 2 x RJ45 10G base-T by Intel® X550-AT2 - 1 x RJ45 Dedicated IPMI LAN port by RTL8211E - Supports Wake-On-LAN - Supports Energy Efficient Ethernet 802.3az - Supports Dual LAN with Teaming function - Supports PXE - LAN1 supports NCSI
Graphics	
Controller	ASPEED AST2500
VRAM	16MB DDR4
Rear Panel I/O	
VGA Port	1 x D-Sub
USB 3.1 Gen2 Port	2

LAN Port	- RJ45: 2x 10GLAN(by Intel® X550-AT2) - LAN Ports with LED (ACT/LINK LED and SPEED LED)
Management LAN Port	1
UID	1
Internal Connector	
ITX_AUX_	1
PANEL1	
PANEL1	1
TR1	1
TPM Header	1
Fan Header	3x (4-pin)
ATX power DC-IN	1x (8-pin)
ATX 4-PIN Power	1x (4-pin)
SATA Power	1x (4-pin)
OCuLink	2
USB 3.1 Gen1 Header	1 (supports 2 USB3.1 Gen1)
ClearCMOS	1 (short pad)
COM Header	1
IPMB	1
PWR SMB	1
BMC_SMB	1
OH/FanFail LED	3
System BIOS	
BIOS Type	256Mb AMI UEFI Legal BIOS
BIOS Features	- Plug and Play (PnP) - ACPI 2.0 Compliance Wake Up Events - SMBIOS 2.8.0 Support - ASRock Rack Instant Flash
Hardware Monitor	
Temperature	- CPU/PCH/DDR/LAN/Storage Temperature Sensing - MB/Card side/TR1 Temperature Sensing
Fan	- CPU/Rear/Front Fan Tachometer - CPU Quiet Fan (Allow Chassis Fan Speed Auto-Adjust by CPU Temperature) - CPU/Rear/Front Fan Multi-Speed Control
Voltage	Voltage Monitoring: 3VSB, 5VSB, VCPU, VSOC, VCCM, APU VDDP, PM VDD CLDO, PM VDDCR S5, PM VDDCR, BAT, 3V, 5V, 12V

Support OS	
OS	TBD
Environment	
Temperature	Operation temperature: 10°C ~ 35°C / Non operation temperature: -40°C ~ 70°C

NOTE: Please refer to our website for the latest specifications.



This motherboard supports Wake from on Board LAN. To use this function, please make sure that the "Wake on Magic Packet from power off state" is enabled in Device Manager > Intel® Ethernet Connection > Power Management. And the "PCI Devices Power On" is enabled in UEFI SETUP UTILITY > Advanced > ACPI Configuration. After that, onboard LAN1&2 can wake up S5 under OS.



If you install Intel® LAN utility or Marvell SATA utility, this motherboard may fail Windows® Hardware Quality Lab (WHQL) certification tests. If you install the drivers only, it will pass the WHQL tests.

1.3 Unique Features

ASRock Rack Instant Flash is a BIOS flash utility embedded in Flash ROM. This convenient BIOS update tool allows you to update system BIOS without entering operating systems first like MS-DOS or Windows[®]. With this utility, you can press the <F6> key during the POST or the <F2> key to enter into the BIOS setup menu to access ASRock Rack Instant Flash. Just launch this tool and save the new BIOS file to your USB flash drive, floppy disk or hard drive, then you can update your BIOS only in a few clicks without preparing an additional floppy diskette or other complicated flash utility. Please be noted that the USB flash drive or hard drive must use FAT32/16/12 file system.

1.4 Motherboard Layout

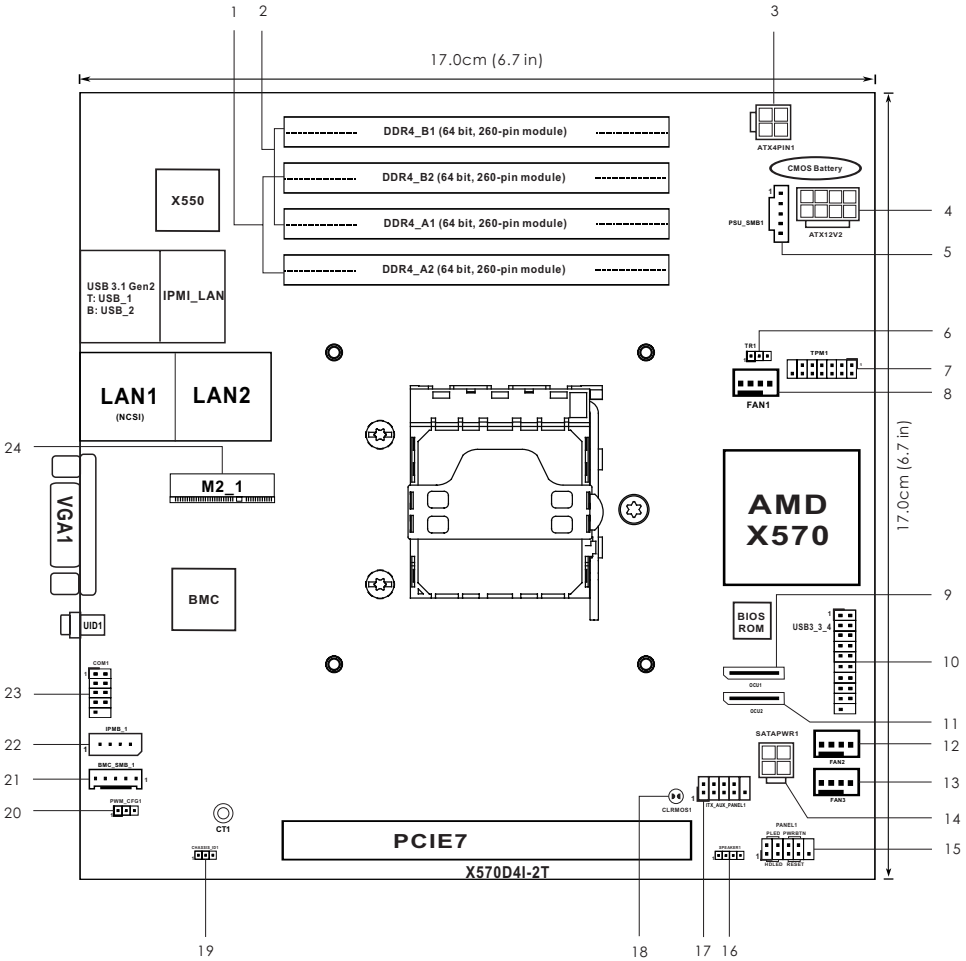

No.	Description
1	2 x 260-pin DDR4 SO-DIMM Slots (DDR4_A2, DDR4_B2)
2	2 x 260-pin DDR4 SO-DIMM Slots (DDR4_A1, DDR4_B1)
3	ATX 4-PIN Power Connector (ATX4PIN1)*
4	ATX 12V Power Connector (ATX12V2)
5	PSU SMBus (PSU_SMB1)
6	Thermal Sensor Header (TR1)
7	TPM Header (TPM1)
8	System Fan Connector (FAN1)
9	OCuLink x4 Connector (OCU1)
10	USB 3.1 Gen1 Header (USB3_3_4)
11	OCuLink x4 Connector (OCU2)
12	System Fan Connector (FAN2)
13	System Fan Connector (FAN3)
14	SATA Power Connector (SATAPWR1)*
15	System Panel Header (PANEL1)
16	Speaker Header (SPEAKER1)
17	Auxiliary Panel Header (ITX_AUX_PANEL1)
18	Clear CMOS Pad (CLRMOS1)
19	Chassis ID Jumper (CHASSIS_ID1)
20	PWM Configuration Header (PWM_CFG1)
21	BMC SMBus Header (BMC_SMB_1)
22	Intelligent Platform Management Bus header (IPMB_1)
23	COM Port Header (COM1)
24	M.2 Socket (M2_1) (Type 2280)

*Caution: Misconnection between the ATX4PIN1 and the SATAPWR1 connectors may permanently damage the motherboard.

1.5 Onboard LED Indicators

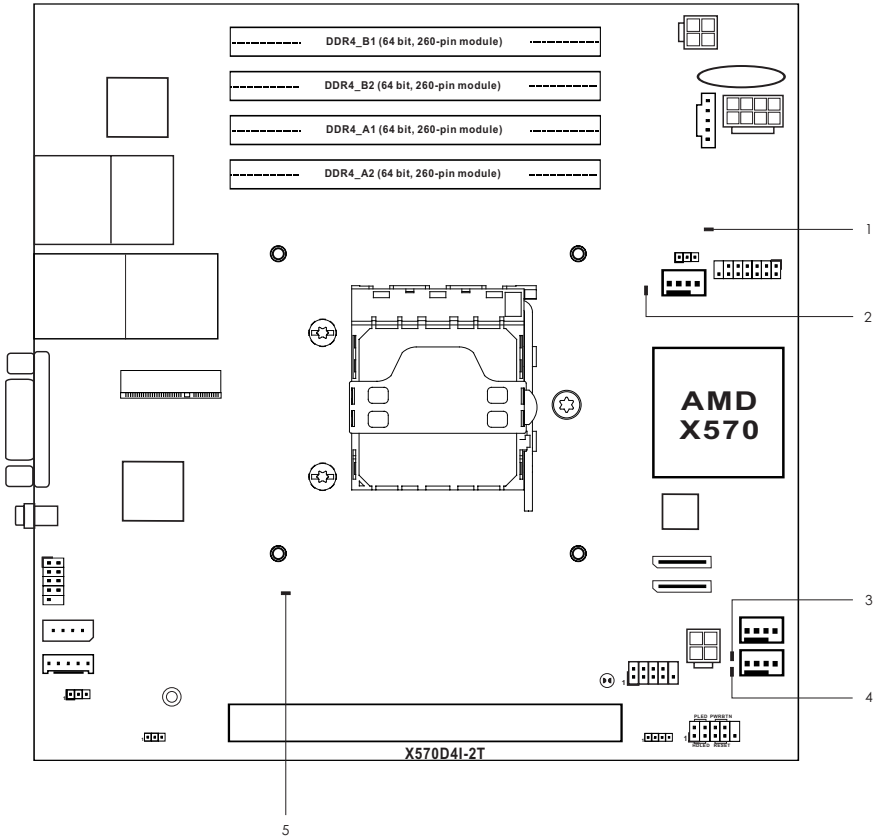

No.	Item	Status	Description
1	SB_PWR1_LED	Green	STB PWR ready
2	LED_FAN1	Amber	FAN1 failed
3	LED_FAN2	Amber	FAN2 failed
4	LED_FAN3	Amber	FAN3 failed
5	BMC_LED1	Green	BMC heartbeat LED

1.6 I/O Panel

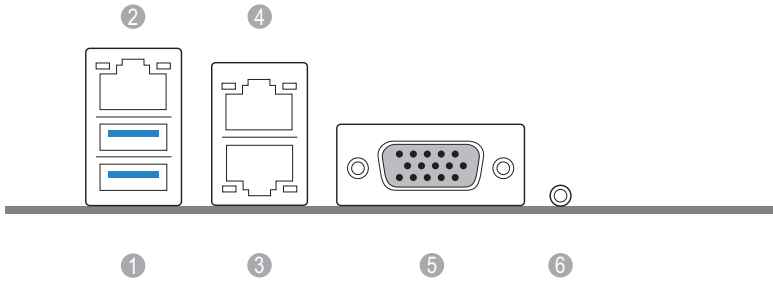

No.	Description	No.	Description
1	USB 3.1 Gen2 Ports (USB3_1_2)	4	10G LAN RJ-45 Port (LAN2)**
2	LAN RJ-45 Port (IPMI_LAN)*	5	VGA Port (VGA1)
3	10G LAN RJ-45 Port (LAN1)**	6	UID Switch (UID1)

LAN Port LED Indications

*There are two LEDs on each LAN port. Please refer to the table below for the LAN port LED indications.

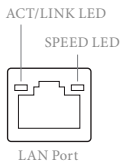

Dedicated IPMI LAN Port LED Indications

Activity / Link LED		Speed LED	
Status	Description	Status	Description
Off	No Link	Off	10Mbps connection or no link
Blinking Yellow	Data Activity	Yellow	100Mbps connection
On	Link	Green	1Gbps connection

**There are two LEDs on each LAN port. Please refer to the table below for the LAN port LED indications.

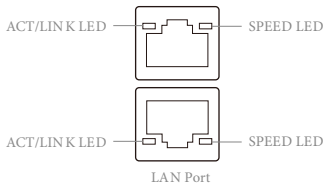

10G LAN Port (LAN1, LAN2) LED Indications

Activity / Link LED		Speed LED	
Status	Description	Status	Description
Off	No Link	Off	10M/100Mbps connection or no link
Blinking Yellow	Data Activity	Orange	1Gbps connection
On	Link	Green	10Gbps connection

Chapter 2 Installation

This is a mini ITX form factor (6.7" x 6.7", 17.02 cm x 17.02 cm) motherboard. Before you install the motherboard, study the configuration of your chassis to ensure that the motherboard fits into it.



Make sure to unplug the power cord before installing or removing the motherboard. Failure to do so may cause physical injuries to you and damages to motherboard components.

2.1 Screw Holes

Place screws into the holes indicated by circles to secure the motherboard to the chassis.



Do not over-tighten the screws! Doing so may damage the motherboard.

2.2 Pre-installation Precautions

Take note of the following precautions before you install motherboard components or change any motherboard settings.

1. Unplug the power cord from the wall socket before touching any components.
2. To avoid damaging the motherboard's components due to static electricity, NEVER place your motherboard directly on the carpet or the like. Also remember to use a grounded wrist strap or touch a safety grounded object before you handle the components.
3. Hold components by the edges and do not touch the ICs.
4. Whenever you uninstall any component, place it on a grounded anti-static pad or in the bag that comes with the component.
5. When placing screws into the screw holes to secure the motherboard to the chassis, please do not over-tighten the screws! Doing so may damage the motherboard.



Before you install or remove any component, ensure that the power is switched off or the power cord is detached from the power supply. Failure to do so may cause severe damage to the motherboard, peripherals, and/or components.

2.3 Installing the CPU



Unplug all power cables before installing the CPU.

1

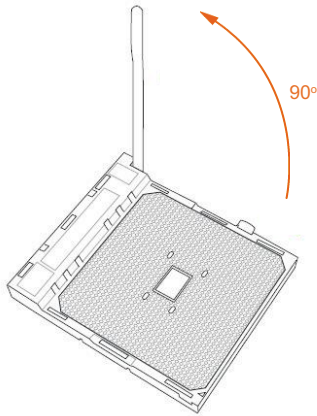

2

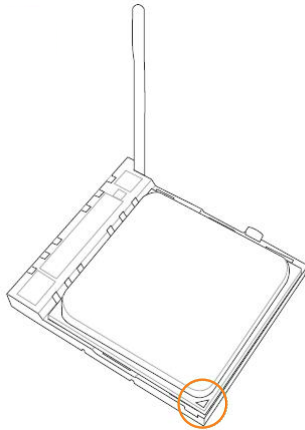

3

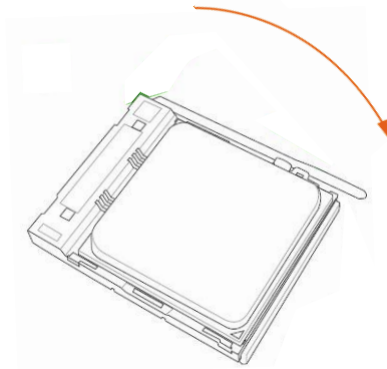

2.4 Installing the CPU Fan and Heatsink



Please be aware that this motherboard only supports LGA115x CPU heatsink

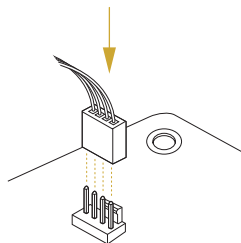
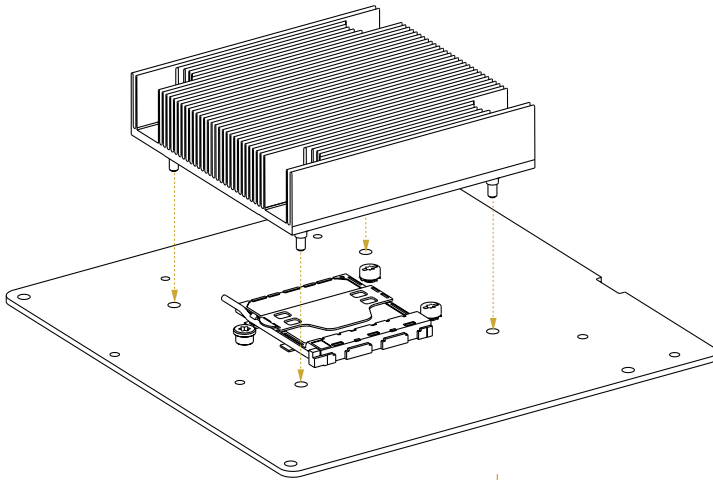

2.5 Installation of Memory Modules (DIMM)

This motherboard provides four 260-pin DDR4 (Double Data Rate 4) DIMM slots.

A single memory module should be installed in the A1 or B1 socket.

Two memory modules should be installed in the A1+B1, A1+A2, or B1+B2 sockets.

	Priority	A1	A2	B1	B2
1 DIMM	1	Populated			
	2			Populated	
2 DIMMS	1	Populated		Populated	
	2	Populated	Populated		
	3			Populated	Populated
4 DIMMS	1	Populated	Populated	Populated	Populated



1. It is not allowed to install a DDR, DDR2 or DDR3 memory module into a DDR4 slot; otherwise, this motherboard and DIMM may be damaged.
2. The DIMM only fits in one correct orientation. It will cause permanent damage to the motherboard and the DIMM if you force the DIMM into the slot at incorrect orientation.

1

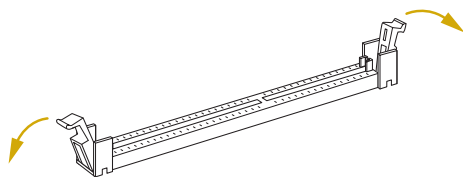

2

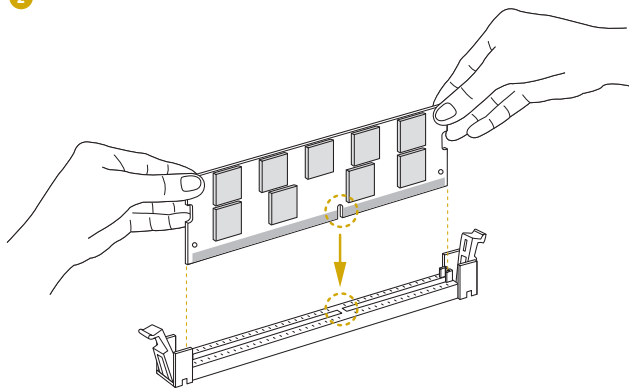

3

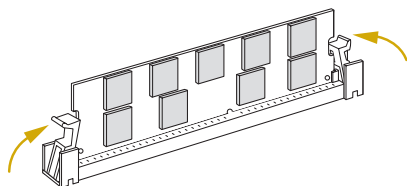

2.6 Expansion Slot (PCI Express Slot)

There is a PCI Express slot on this motherboard.

PCIe slot:

PCIe7 (PCIe 3.0/4.0 x16 slot) is used for PCI Express x16 lane width cards.

Slot	Generation	Mechanical	Electrical	Source
PCIe 7	3.0/4.0	x16	x8 or x16 <i>(Depending on the CPU Type)</i>	CPU

Installing an expansion card

- Step 1. Before installing an expansion card, please make sure that the power supply is switched off or the power cord is unplugged. Please read the documentation of the expansion card and make necessary hardware settings for the card before you start the installation.
- Step 2. Remove the system unit cover (if your motherboard is already installed in a chassis).
- Step 3. Remove the bracket facing the slot that you intend to use. Keep the screws for later use.
- Step 4. Align the card connector with the slot and press firmly until the card is completely seated on the slot.
- Step 5. Fasten the card to the chassis with screws.
- Step 6. Replace the system cover.

2.7 Jumper Setup

The illustration shows how jumpers are setup. When the jumper cap is placed on the pins, the jumper is “Short”. If no jumper cap is placed on the pins, the jumper is “Open”. The illustration shows a 3-pin jumper whose pin1 and pin2 are “Short” when a jumper cap is placed on these 2 pins.

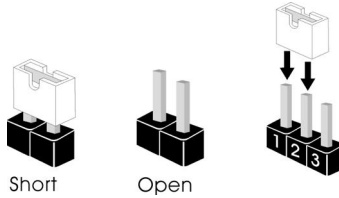

CHASSIS ID Jumper
(3-pin CHASSIS_ID1)
(see p.6, No. 19)



Board Level SKU (Default)



Reserved for system level
use

2.8 Onboard Headers and Connectors



Onboard headers and connectors are NOT jumpers. Do NOT place jumper caps over these headers and connectors. Placing jumper caps over the headers and connectors will cause permanent damage to the motherboard.

System Panel Header
(9-pin PANEL1)
(see p.6, No. 15)

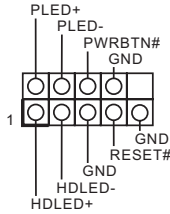

Connect the power switch, reset switch and system status indicator on the chassis to this header according to the pin assignments. Particularly note the positive and negative pins before connecting the cables.



PWRBTN (Power Switch):

Connect to the power switch on the chassis front panel. You may configure the way to turn off your system using the power switch.

RESET (Reset Switch):

Connect to the reset switch on the chassis front panel. Press the reset switch to restart the computer if the computer freezes and fails to perform a normal restart.

PLED (System Power LED):

Connect to the power status indicator on the chassis front panel. The LED is on when the system is operating. The LED is off when the system is in S4 sleep state or powered off (S5).

HDLED (Hard Drive Activity LED):

Connect to the hard drive activity LED on the chassis front panel. The LED is on when the hard drive is reading or writing data.

The front panel design may differ by chassis. A front panel module mainly consists of power switch, power LED, hard drive activity LED, speaker and etc. When connecting your chassis front panel module to this header, make sure the wire assignments and the pin assignments are matched correctly.

Auxiliary Panel Header
(9-pin
ITX_AUX_PANEL1)
(see p.6, No. 17)

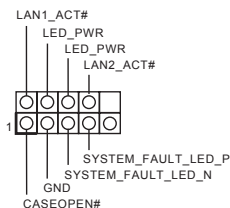

This header supports multiple functions on the front panel, including front panel SMB, internet status indicator.

ATX 12V Power
Connector
(8-pin ATX12V2)
(see p.6, No. 4)

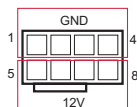

The motherboard provides one 8-pin 12V power connector which is a required input for either DC-IN 12V or ATX +12V power source.

When using ATX power, it is necessary to use a 24pin-to-4pin power cable to connect between the 24pin power connector of PSU and the ATX4PIN1 connector on the motherboard for power supply and signal communication.

ATX 4-PIN Power
Connector
(4-pin ATX4PIN1)
(see p.6, No. 3)

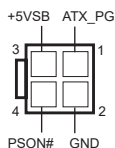

The motherboard provides one 4-pin power/signal connector which is a required input for ATX power source.

When using ATX power, it is necessary to use a 24pin-to-4pin power cable to connect between the 24pin power connector of PSU and the ATX4PIN1 connector on the motherboard for power supply and signal communication.

For DC-IN 12V application, it is not necessary to use this ATX 4-PIN power connector.

**Caution: Misconnection between the ATX4PIN1 and the SATAPWR1 connectors may permanently damage the motherboard.*

SATA Power Connector
(4-pin SATAPWR1)
(see p.6, No. 14)

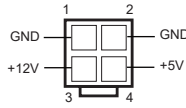

Please use a SATA power cable to connect this SATA Power Connector and your SATA HDD for supplying power from the motherboard, when using DC-IN mode without SATA power supply.

**Caution: Misconnection between the ATX4PIN1 and the SATAPWR1 connectors may permanently damage the motherboard.*

USB 3.1 Gne1 Header
(19-pin USB3_3_4)
(see p.6, No. 10)

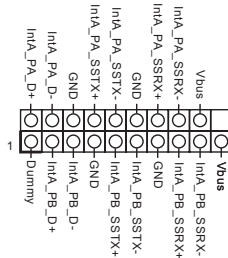

Besides two default USB 3.1 Gen1 ports on the I/O panel, there is one USB 3.1 Gen1 header on this motherboard. This USB 3.1 Gen1 header can support two USB 3.1 Gen1 ports.

System Fan Connectors
(4-pin FAN1)
(see p.6, No. 8)
(4-pin FAN2)
(see p.6, No. 12)
(4-pin FAN3)
(see p.6, No. 13)

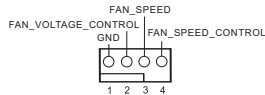

Please connect fan cables to the fan connector and match the black wire to the ground pin. All fans support Fan Control.

TPM Header
(13-pin TPM1)
(see p.6, No. 7)

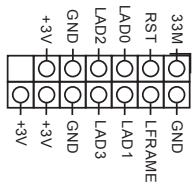

This connector supports Trusted Platform Module (TPM) system, which can securely store keys, digital certificates, passwords, and data. A TPM system also helps enhance network security, protects digital identities, and ensures platform integrity.

Thermal Sensor Header
(3-pin TR1)
(see p.6, No. 6)



Please connect the thermal sensor cable to either pin 1-2 or pin 2-3 and the other end to the device which you wish to monitor its temperature.

PWM Configuration Header
(3-pin PWM_CFG1)
(see p.6, No. 20)



This header is used for PWM configurations.

OCuLink Connectors
(OCU1)
(see p.6, No.9)
(OCU2)
(see p.6, No. 11)



Please connect PCIE SSDs or OCuLink-to-SATA x4 cable to the connectors.

Serial Port Header
(9-pin COM1)
(see p.6, No. 23)

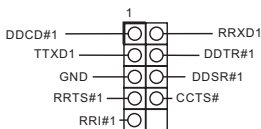

This COM header supports a serial port module.

Clear CMOS Pad
(CLRMOS1)
(see p.6, No. 18)



CLRMOS1 allows you to clear the data in CMOS. To clear CMOS, take out the CMOS battery and short the Clear CMOS Pad.

Chassis Speaker Header
(4-pin SPEAKER1)
(see p.6, No. 16)



Please connect the chassis speaker to this header.

PSU SMBus
(PSU_SMB1)
(see p.6, No. 5)

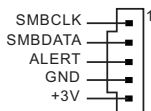

PSU SMBus monitors the status of the power supply, fan and system temperature.

Intelligent Platform
Management Bus Header
(4-pin IPMB_1)
(see p.6, No. 22)

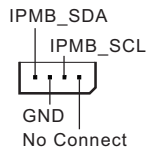

This 4-pin connector is used to provide a cabled base-board or front panel connection for value added features and 3rd-party add-in cards, such as Emergency Management cards, that provide management features using the IPMB.

Baseboard Management
Controller SMBus Header
(5-pin BMC_SMB_1)
(see p.6, No. 21)

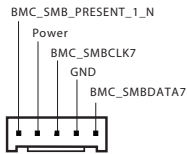

The header is used for the SMBUS devices.

2.9 ATX PSU / DC-IN Power Connections

This motherboard supports both +12V DC and ATX power input. Please refer to the table below for the required connections between the motherboard and the power supply.

Connector	DC-IN	ATX PSU
12V 8pin	O	O
ATX 4pin	X	O <i>(with the bundled ATX 24pin-to-4pin converter cable)</i>

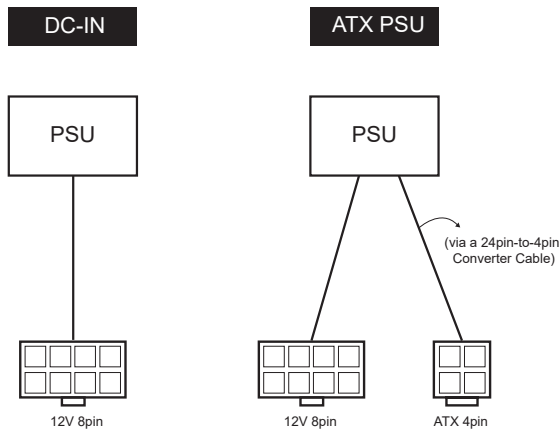

The following diagram illustrates how to connect the bundled ATX 24pin-to-4pin converter cable.

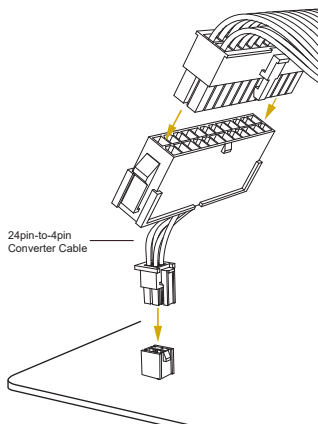

2.10 Unit Identification purpose LED/Switch

With the UID button, You are able to locate the server you're working on from behind a rack of servers.

Unit Identification
purpose LED/Switch
(UID1)



When the UID button on the front or rear panel is pressed, the front/rear UID blue LED indicator will be turned on. Press the UID button again to turn off the indicator.

2.11 Driver Installation Guide

To install the drivers to your system, please insert the support CD to your optical drive first. Then, the drivers compatible to your system can be auto-detected and listed on the support CD driver page. Please follow the order from top to bottom to install those required drivers. Therefore, the drivers you install can work properly.

2.12 Dual LAN and Teaming Operation Guide

Dual LAN with Teaming enabled on this motherboard allows two single connections to act as one single connection for twice the transmission bandwidth, making data transmission more effective and improving the quality of transmission of distant images. Fault tolerance on the dual LAN network prevents network downtime by transferring the workload from a failed port to a working port.



The speed of transmission is subject to the actual network environment or status even with Teaming enabled.

Before setting up Teaming, please make sure whether your Switch (or Router) supports Teaming (IEEE 802.3ad Link Aggregation). You can specify a preferred adapter in Intel PROSet. Under normal conditions, the Primary adapter handles all non-TCP/IP traffic. The Secondary adapter will receive fallback traffic if the primary fails. If the Preferred Primary adapter fails, but is later restored to an active status, control is automatically switched back to the Preferred Primary adapter.

Step 1

From **Device Manager**, open the properties of a team.

Step 2

Click the **Settings** tab.

Step 3

Click the **Modify Team** button.

Step 4

Select the adapter you want to be the primary adapter and click the **Set Primary** button.

If you do not specify a preferred primary adapter, the software will choose an adapter of the highest capability (model and speed) to act as the default primary. If a failover occurs, another adapter becomes the primary. The adapter will, however, rejoin the team as a non-primary.

2.13 M.2_SSD (NGFF) Module Installation Guide (M2_1)

The M.2, also known as the Next Generation Form Factor (NGFF), is a small size and versatile card edge connector that aims to replace mPCIe and mSATA. This M.2_SSD (NGFF) Socket 3 can accommodate a SATA3 6.0 Gb/s module or a PCI Express module up to Gen4 x4 (64 Gb/s) only.

Installing the M.2_SSD (NGFF) Module

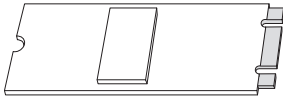

Step 1

Prepare a M.2_SSD (NGFF) module and the screw.

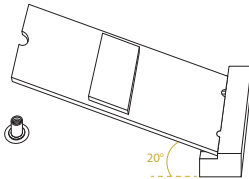

Step 2

Gently insert the M.2 (NGFF) SSD module into the M.2 slot. Please be aware that the M.2 (NGFF) SSD module only fits in one orientation.

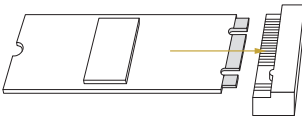

Step 3

Tighten the screw with a screwdriver to secure the module into place. Please do not overtighten the screw as this might damage the module.

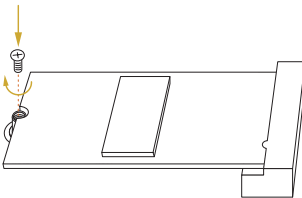

M.2_SSD (NGFF) Module Support List

For the latest updates of M.2_SSD (NFGG) module support list, please visit our website for details: <http://www.asrockrack.com>

Chapter 3 UEFI Setup Utility

3.1 Introduction

This section explains how to use the UEFI SETUP UTILITY to configure your system. The UEFI chip on the motherboard stores the UEFI SETUP UTILITY. You may run the UEFI SETUP UTILITY when you start up the computer. Please press <F2> or during the Power-On-Self-Test (POST) to enter the UEFI SETUP UTILITY; otherwise, POST will continue with its test routines.

If you wish to enter the UEFI SETUP UTILITY after POST, restart the system by pressing <Ctrl> + <Alt> + <Delete>, or by pressing the reset button on the system chassis. You may also restart by turning the system off and then back on.



Because the UEFI software is constantly being updated, the following UEFI setup screens and descriptions are for reference purpose only, and they may not exactly match what you see on your screen.

3.1.1 UEFI Menu Bar

The top of the screen has a menu bar with the following selections:

Item	Description
Main	To set up the system time/date information
Advanced	To set up the advanced UEFI features
Server Mgmt	To manage the server
Security	To set up the security features
Boot	To set up the default system device to locate and load the Operating System
Exit	To exit the current screen or the UEFI SETUP UTILITY

Use <←→> key or <→> key to choose among the selections on the menu bar, and then press <Enter> to get into the sub screen.

3.1.2 Navigation Keys

Please check the following table for the function description of each navigation key.

Navigation Key(s)	Function Description
← / →	Moves cursor left or right to select Screens
↑ / ↓	Moves cursor up or down to select items
+ / -	To change option for the selected items
<Tab>	Switch to next function
<Enter>	To bring up the selected screen
<PGUP>	Go to the previous page
<PGDN>	Go to the next page
<HOME>	Go to the top of the screen
<END>	Go to the bottom of the screen
<F1>	To display the General Help Screen
<F7>	Discard changes and exit the UEFI SETUP UTILITY
<F9>	Load optimal default values for all the settings
<F10>	Save changes and exit the UEFI SETUP UTILITY
<F12>	Print screen
<ESC>	Jump to the Exit Screen or exit the current screen

3.2 Main Screen

Once you enter the UEFI SETUP UTILITY, the Main screen will appear and display the system overview. The Main screen provides system overview information and allows you to set the system time and date.

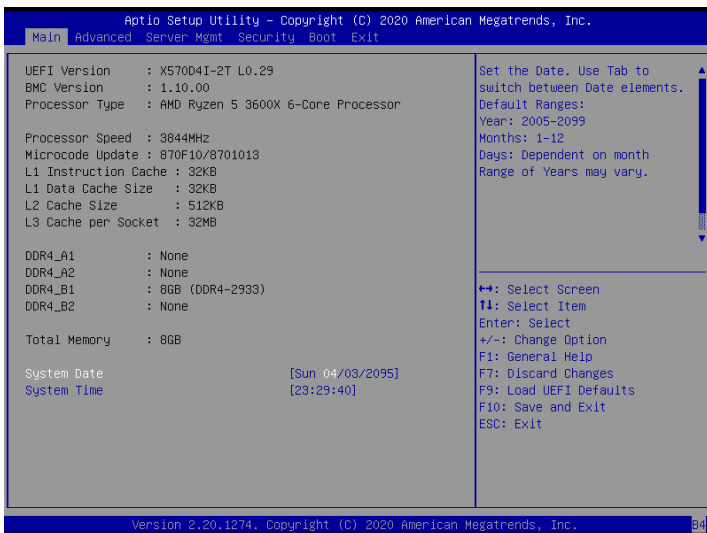

3.3 Advanced Screen

In this section, you may set the configurations for the following items: CPU Configuration, Chipset Configuration, Storage Configuration, ACPI Configuration, USB Configuration, Super IO Configuration, Serial Port Console Redirection, H/W Monitor, Tls Auth Configuration, Network Stack Configuration, AMD CBS, AMD PBS, AMD Overclocking, RAM Disk Configuration and Instant Flash.

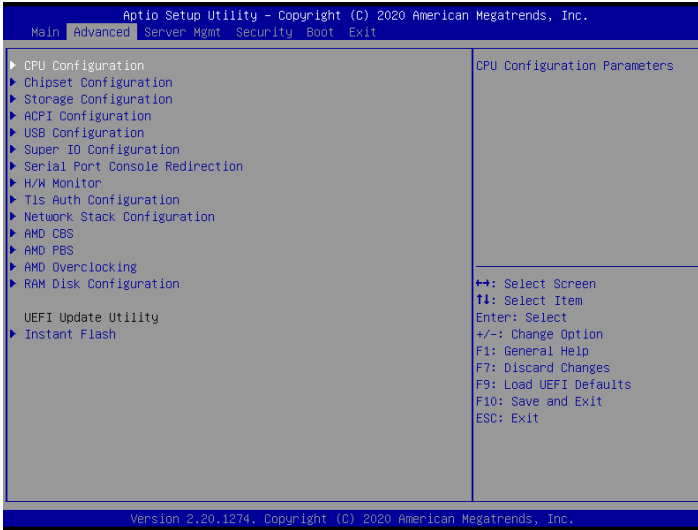

Save User Default

Type a profile name and press enter to save your settings as user default.

Load User Default

Load previously saved user defaults.



Setting wrong values in this section may cause the system to malfunction.

3.3.1 CPU Configuration

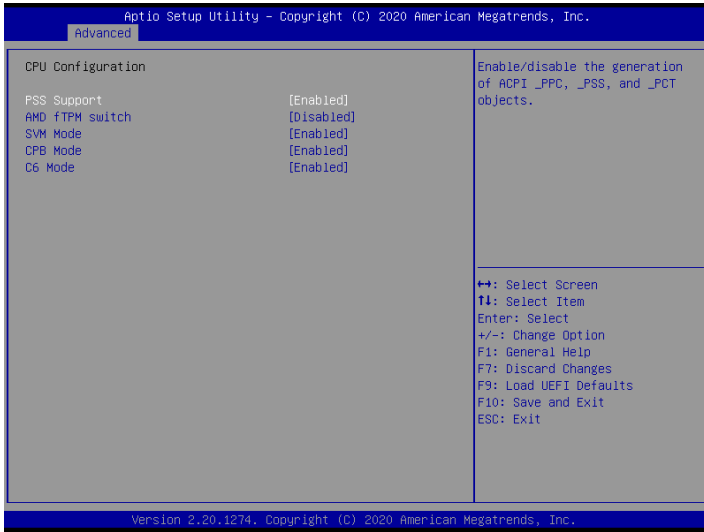

PSS Support

Use this item to enable or disable the generation of ACPI _PPC, _PPS, and _PCT objects.

AMD fTPM Switch

To select .0: Auto (Depend on Tcg module). 1: Disabled fTPM. 2: OnBoard SPI TPM2.0

SVM Mode

Use this item to enable or disable CPU Virtualization.

CPB Mode

Use this item to enable or disable CPB.

C6 Mode

Use this item to enable or disable C6.

3.3.2 Chipset Configuration

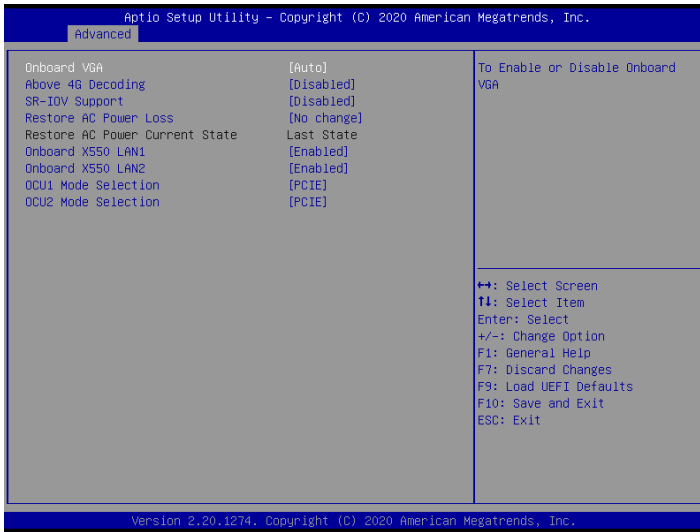

Onboard VGA

Use this to enable or disable the Onboard VGA function. The default value is [Auto].

Above 4G Decoding

Enable or disable 64bit capable Devices to be decoded in Above 4G Address Space (only if the system supports 64 bit PCI decoding).

SR-IOV Support

If system has SR-IOV capable PCIe Devices, this option Enables or Disables Single Root IO Virtualization Support.

Restore AC Power Loss

This allows you to set the power state after an unexpected AC/power loss. If [Power Off] is selected, the AC/power remains off when the power recovers. If [Power On] is selected, the AC/power resumes and the system starts to boot up when the power recovers. If [Last State] is selected, it will recover to the state before AC/power loss.

Restore AC Power Current State

This allows you to restore AC Power Current State.

Onboard X550 LAN1

Use this to enable or disable the onboard LAN.

Onboard X550 LAN2

Use this to enable or disable the onboard LAN.

OCU1 Mode Selection

Switch OCU Link 1 to be PCIE or SATA.

OCU2 Mode Selection

Switch OCU Link 2 to be PCIE or SATA.

3.3.3 Storage Configuration

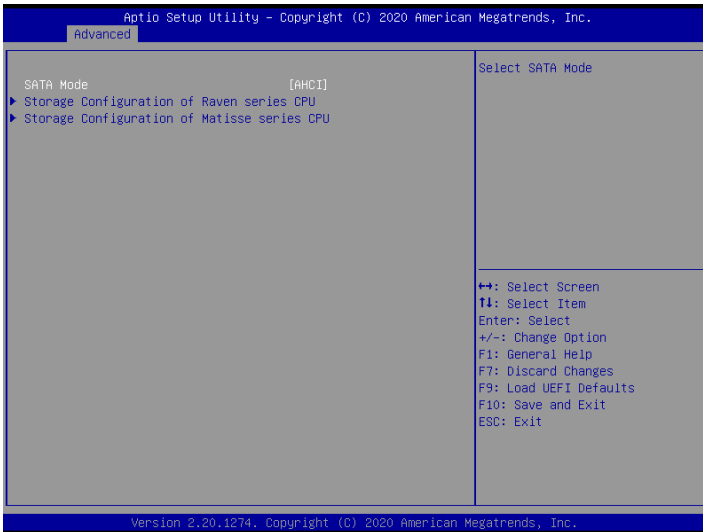

SATA Mode

Use this item to select SATA mode.

Storage Configuration of Raven series CPU

Use this item to configure storage devices of Raven series CPU.

Storage Configuration of Matisse series CPU

Use this item to configure storage devices of Matisse series CPU.

3.3.4 ACPI Configuration

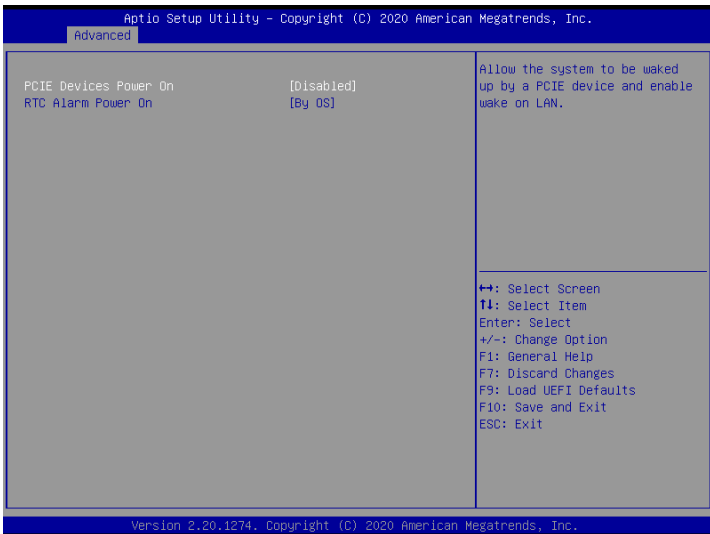

PCIE Devices Power On

Use this item to enable or disable PCIE devices to turn on the system from the power-soft-off mode.

RTC Alarm Power On

Use this item to enable or disable RTC (Real Time Clock) to power on the system.

3.3.5 USB Configuration



Legacy USB Support

Use this option to enable or disable legacy support for USB devices. The default value is [Enabled].

3.3.6 Super IO Configuration

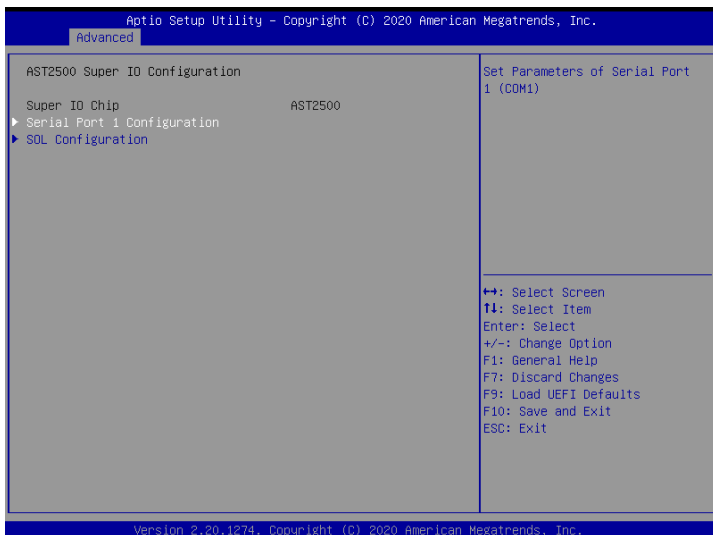

Serial Port 1 Configuration

Use this item to set parameters of Serial Port 1 (COM1).

Serial Port

Use this item to enable or disable the onboard serial port.

Change Settings

Use this item to select an optimal setting for Super IO device.

SOL Port Configuration

Use this item to set parameters of SOL.

SOL Port Configuration

Use this item to enable or disable Serial Port (SOL).

SOL Port Address

Use this item to select an optimal setting for Super IO device.

3.3.7 Serial Port Console Redirection

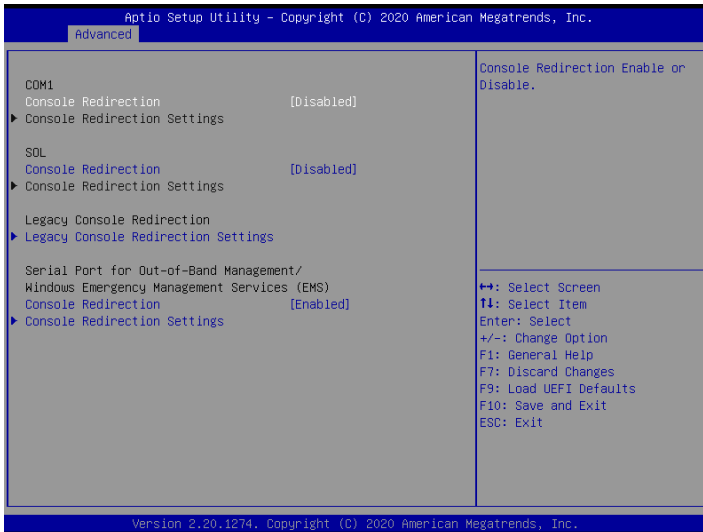

COM1 / SOL

Console Redirection

Use this option to enable or disable Console Redirection. If this item is set to Enabled, you can select a COM Port to be used for Console Redirection.

Console Redirection Settings

Use this option to configure Console Redirection Settings, and specify how your computer and the host computer to which you are connected exchange information.

Terminal Type

Use this item to select the preferred terminal emulation type for out-of-band management. It is recommended to select [VT-UTF8].

Option	Description
VT100	ASCII character set
VT100+	Extended VT100 that supports color and function keys
VT-UTF8	UTF8 encoding is used to map Unicode chars onto 1 or more bytes
ANSI	Extended ASCII character set

Bits Per Second

Use this item to select the serial port transmission speed. The speed used in the host computer and the client computer must be the same. Long or noisy lines may require lower transmission speed. The options include [9600], [19200], [57600] and [115200].

Data Bits

Use this item to set the data transmission size. The options include [7] and [8] (Bits).

Parity

Use this item to select the parity bit. The options include [None], [Even], [Odd], [Mark] and [Space].

Stop Bits

The item indicates the end of a serial data packet. The standard setting is [1] Stop Bit. Select [2] Stop Bits for slower devices.

Flow Control

Use this item to set the flow control to prevent data loss from buffer overflow. When sending data, if the receiving buffers are full, a "stop" signal can be sent to stop the data flow. Once the buffers are empty, a "start" signal can be sent to restart the flow. Hardware flow uses two wires to send start/stop signals. The options include [None] and [Hardware RTS/CTS].

VT-UTF8 Combo Key Support

Use this item to enable or disable the VT-UTF8 Combo Key Support for ANSI/VT100 terminals.

Recorder Mode

Use this item to enable or disable Recorder Mode to capture terminal data and send it as text messages.

Resolution 100x31

Use this item to enable or disable extended terminal resolution support.

Putty Keypad

Use this item to select Function Key and Keypad on Putty.

Legacy Console Redirection

Legacy Console Redirection Settings

Use this option to configure Legacy Console Redirection Settings, and specify how your computer and the host computer to which you are connected exchange information.

Redirection COM Port

Select a COM port to display redirection of Legacy OS and Legacy OPROM Messages.

Resolution

On Legacy OS, the Number of Rows and Columns supported redirection.

Redirect After POST

When Bootloader is selected, then Legacy Console Redirection is disabled before booting to legacy OS. When Always Enable is selected, then Legacy Console Redirection is enabled for legacy OS. Default setting for this option is set to Always Enable.

Serial Port for Out-of-Band Management/Windows Emergency Management Services (EMS)

Console Redirection

Use this option to enable or disable Console Redirection. If this item is set to Enabled, you can select a COM Port to be used for Console Redirection.

Console Redirection Settings

Use this option to configure Console Redirection Settings, and specify how your computer and the host computer to which you are connected exchange information.

Out-of-Band Mgmt Port

Microsoft Windows Emergency Management Services (EMS) allows for remote management of a Windows Server OS through a serial port.

Terminal Type

Use this item to select the preferred terminal emulation type for out-of-band management. It is recommended to select [VT-UTF8].

Option	Description
VT100	ASCII character set
VT100+	Extended VT100 that supports color and function keys
VT-UTF8	UTF8 encoding is used to map Unicode chars onto 1 or more bytes
ANSI	Extended ASCII character set

Bits Per Second

Use this item to select the serial port transmission speed. The speed used in the host computer and the client computer must be the same. Long or noisy lines may require lower transmission speed. The options include [9600], [19200], [57600] and [115200].

Flow Control

Use this item to set the flow control to prevent data loss from buffer overflow. When sending data, if the receiving buffers are full, a "stop" signal can be sent to stop the data flow. Once the buffers are empty, a "start" signal can be sent to restart the flow. Hardware flow uses two wires to send start/stop signals. The options include [None], [Hardware RTS/CTS], and [Software Xon/Xoff].

Data Bits

Parity

Stop Bits

3.3.8 H/W Monitor

In this section, it allows you to monitor the status of the hardware on your system, including the parameters of the CPU temperature, motherboard temperature, CPU fan speed, chassis fan speed, and the critical voltage.

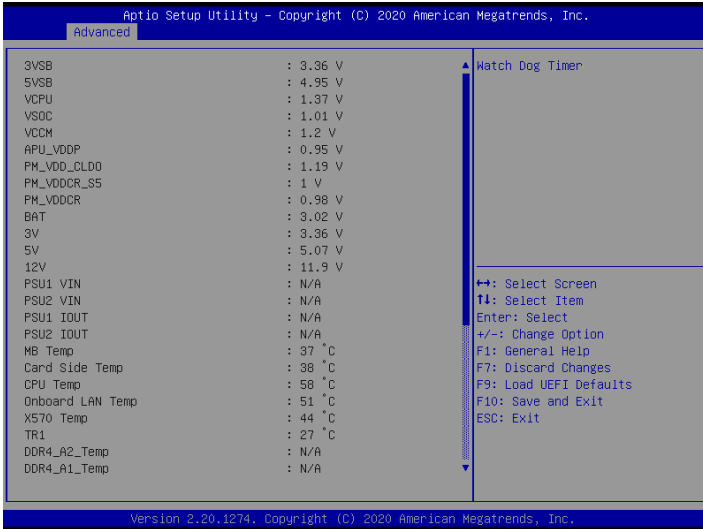

Watch Dog Timer

This allows you to enable or disable the Watch Dog Timer. The default value is [Disabled].

3.3.9 Tls Auth Configuration

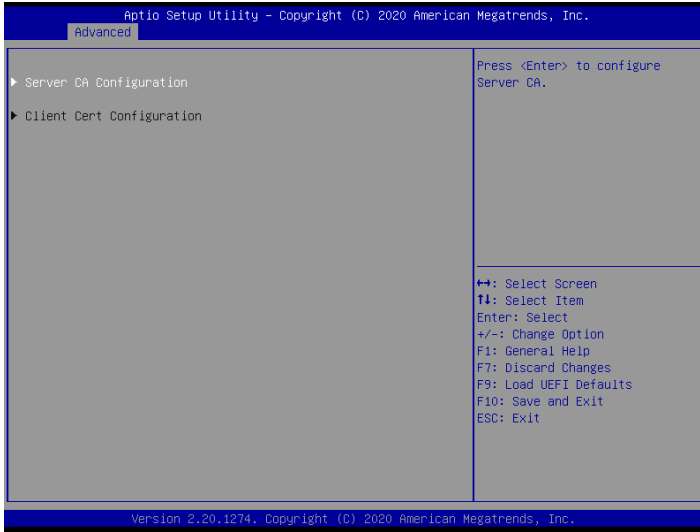

Server CA Configuration

Press <Enter> to configure Server CA.

Client Cert Configuration

Press <Enter> to configure Client Cert.

3.3.10 Network Stack Configuration

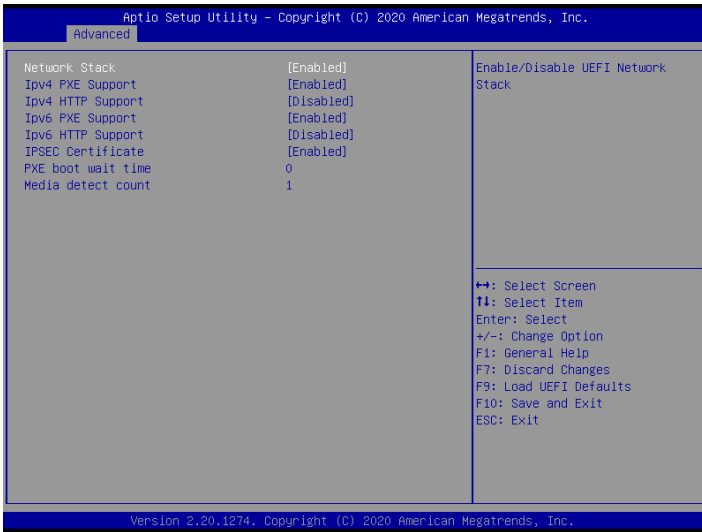

Network Stack

Use this item to enable or disable UEFI Network Stack.

IPv4 PXE Support

Use this item to enable or disable IPv4 PXE boot support. If disabled, IPv4 PXE boot support will not be available.

IPv4 HTTP Support

Use this item to enable or disable IPv4 HTTP boot support. If disabled, IPv4 HTTP boot support will not be available.

IPv6 PXE Support

Use this item to enable or disable IPv6 PXE boot support. If disabled, IPv6 PXE boot support will not be available.

IPv6 HTTP Support

Use this item to enable or disable IPv6 HTTP boot support. If disabled, IPv6 HTTP boot support will not be available.

IPSEC Certificate

Support to Enable/Disable IPSEC certificate for Ikev.

PXE boot wait time

Wait time in seconds to press ESC key to abort the PXE boot. Use either +/- or numeric keys to set the value.

Media detect count

Number of times the presence of media will be checked. Use either +/- or numeric keys to set the value.

3.3.11 AMD CBS

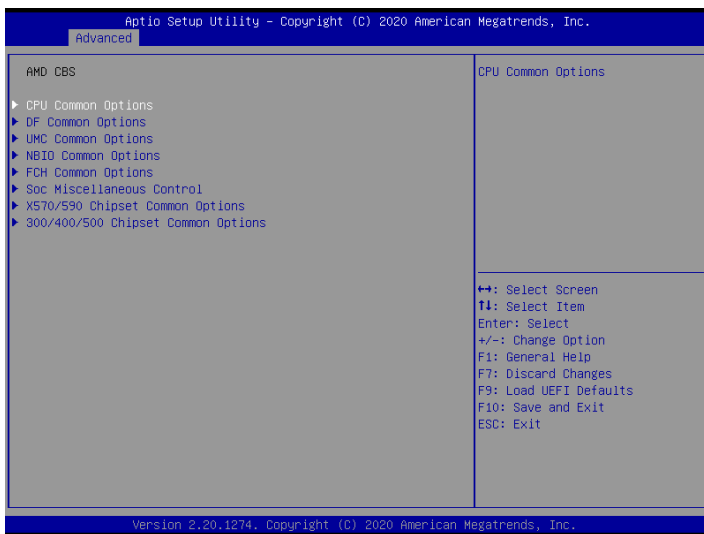

CPU Common Options

Use this item to configure CPU Common options.

DF Common Options

Use this item to configure DF Common options.

NBIO Common Options

Use this item to configure NBIO Common options.

FCH Common Options

Use this item to configure FCH Common options.

Soc Miscellaneous Control

Use this item to configure Soc Miscellaneous Control options.

X570/590 Chipset Common Options

Use this item to configure X570/X590 Chipset Common options.

300/400/500 Chipset Common Options

Use this item to configure 300/400/500 Chipset Common options.

3.3.12 AMD PBS

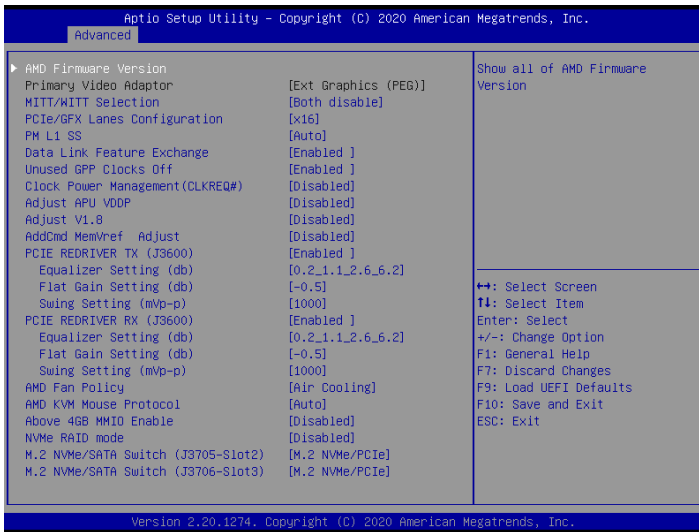

AMD Firmware Version

Show all of AMD Firmware Version.

MITT/WITT Selection

Use this item to configure MITT/WITT Selection.

PCIe/GFX Lanes Configuration

Configure J10 & J3600 Slot PCIe Lanes. Auto - If J3600 Slot is connected to a device, J10 and J3600 both are x8, otherwise, J10 is x16; x8x4x4 - J10: x8, J3600: 4x4; x4x4x4x4 - J10: x4x4x4x4 (J3600 Slot can't connect to any device).

PM L1 SS

Enable for PM L1 SS and SPM L1 SS

Data Link Feature Exchange

Enable or Disable Data Link Feature Exchange, try to disable it if any Legacy Endpoint can not boot.

Unused GPP Clocks Off

Turn Unused GPP Clocks Off.

Clock Power Mangement (CLKREQ#)

Enable or disable CLKREQ#

Adjust APU VDDP

Adjust APU VDDP, stepping is 2.5mV. $V_{ddp} = 1.05V \pm N * 2.5 \text{ mV}$, input range is 0-127.

Adjust V1.8

Adjust V1.8, stepping is 3mV. $V1.8 = 1.8V \pm N * 1 \text{ mV}$, input range is 0-127.

AddCmd MemVref Adjust

AddCmd MemVref Adjust, stepping is $VDDIO * (1/256)$. $MEM_VREF = VDDIO * (N / 256)$, input range is 1-255.

PCIE REDRIVER TX (J3600)

PCIE REDRIVER TX (J3600) - U3608, U3601.

Equalizer Setting (db)

EQ[2:0] are the selection pins for the equalization selection. It corresponds to @1.25GHz_@2.5GHz_@4GHz_@8GHz in turn.

Flat Gain Setting (db)

FG[1:0] are the selection butts for the DC gain.

Swing Setting (mVp-p)

SW[1:0] are the selection bits for the output swing value.

PCIE REDRIVER RX (J3600)

PCIE REDRIVER RX (J3600) - U3602, U3603.

Equalizer Setting (db)

EQ[2:0] are the selection pins for the equalization selection. It corresponds to @1.25GHz_@2.5GHz_@4GHz_@8GHz in turn.

Flat Gain Setting (db)

FG[1:0] are the selection butts for the DC gain.

Swing Setting (mVp-p)

SW[1:0] are the selection bits for the output swing value.

AMD Fan Policy

[Air Cooling] follows platform defined policy, [Water Cooling] forces PWM 100%; Selecting [Fan Control] to [Manual] in CBS will override this option.

AMD KVM Mouse Protocol

Switch KVM Mouse Protocol between Absolut/Simple

Above 4GB MMIO Enable

Enable or disable Above 4GB MMIO.

NVMe RAID mode

Enable or disable NVMe RAID mode.

M.2 NVMe/SATA Switch (J3705-Slot2)

The signals are auto switched by HW detection.

M.2 NVMe/SATA Switch (J3706-Slot3)

The signals are auto switched by HW detection.

3.3.13 AMD Overclocking

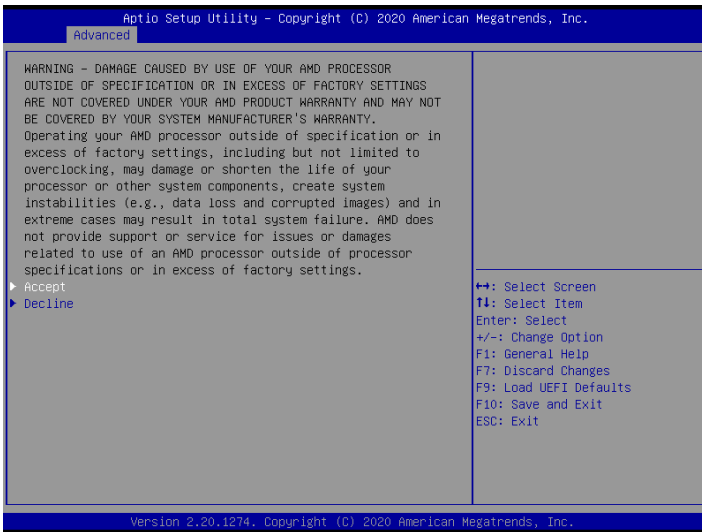

The AMD Overclocking menu accesses options for configuring CPU frequency and voltage.

3.3.14 RAM Disk Configuration

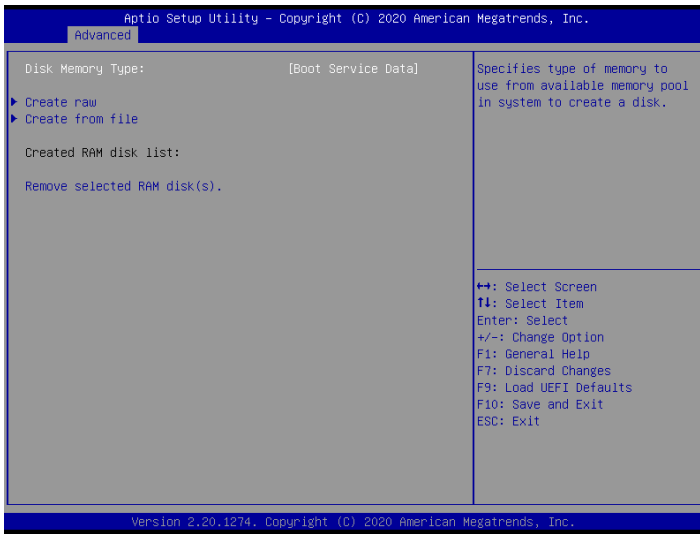

Disk Memory Type

Specifies type of memory to use from available memory pool in system to create a disk.

Create raw

Create a raw RAM disk.

Create from file

Create a RAM disk from a given file.

Remove selected RAM disk(s).

Remove selected RAM disk(s)

3.3.15 Instant Flash

Instant Flash is a UEFI flash utility embedded in Flash ROM. This convenient UEFI update tool allows you to update system UEFI without entering operating systems first like MS-DOS or Windows. Just save the new UEFI file to your USB flash drive, floppy disk or hard drive and launch this tool, then you can update your UEFI only in a few clicks without preparing an additional floppy diskette or other complicated flash utility. Please be noted that the USB flash drive or hard drive must use FAT32/16/12 file system. If you execute Instant Flash utility, the utility will show the UEFI files and their respective information. Select the proper UEFI file to update your UEFI, and reboot your system after the UEFI update process is completed.

3.4 Server Mgmt



Wait For BMC

Wait For BMC response for specified time out. BMC starts at the same time when BIOS starts during AC power ON. It takes around 90 seconds to initialize Host to BMC interfaces.

3.4.1 System Event Log

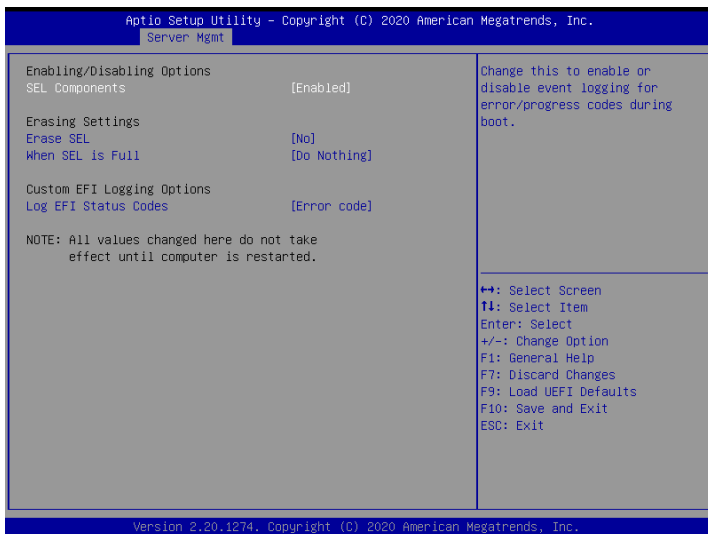

SEL Components

Change this to enable or disable event logging for error/progress codes during boot.

Erase SEL

Use this to choose options for erasing SEL.

When SEL is Full

Use this to choose options for reactions to a full SEL.

Log EFI Status Codes

Use this item to disable the logging of EFI Status Codes or log only error code or only progress code or both.

3.4.2 BMC Network Configuration

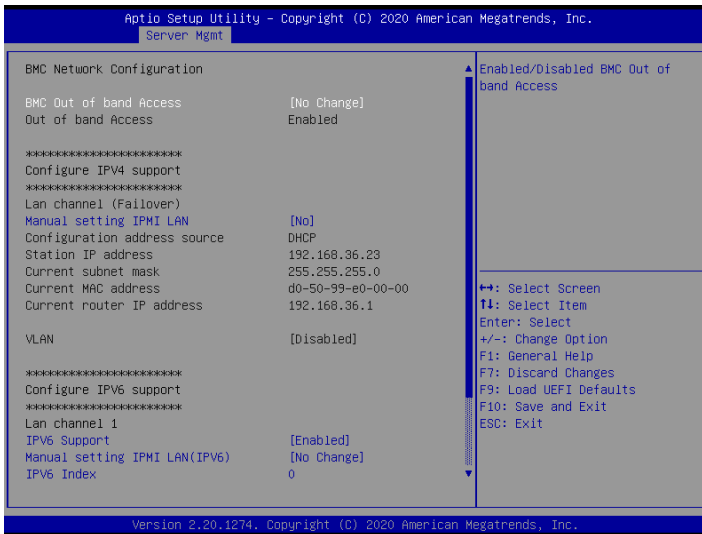

BMC Out of Band Access

Enabled/Disabled BMC Out of band Access.

Manual Setting IPMI LAN

If [No] is selected, the IP address is assigned by DHCP. If you prefer using a static IP address, toggle to [Yes], and the changes take effect after the system reboots. The default value is [No].

Configuration Address Source

Select to configure BMC network parameters statically or dynamically (by BIOS or BMC). Configuration options: [Static] and [DHCP].

Static: Manually enter the IP Address, Subnet Mask and Gateway Address in the BIOS for BMC LAN channel configuration.

DHCP: IP address, Subnet Mask and Gateway Address are automatically assigned by the network's DHCP server.



When [DHCP] or [Static] is selected, do NOT modify the BMC network settings on the IPMI web page.



The default login information for the IPMI web interface is:

Username: admin

Password: admin

For more instructions on how to set up remote control environment and use the IPMI management platform, please refer to the IPMI Configuration User Guide or go to the Support website at: <http://www.asrockrack.com/support/faq.asp>

IPV6 Support

Enable or Disable LAN1 IPV6 Support.

3.4.3 BMC Tools

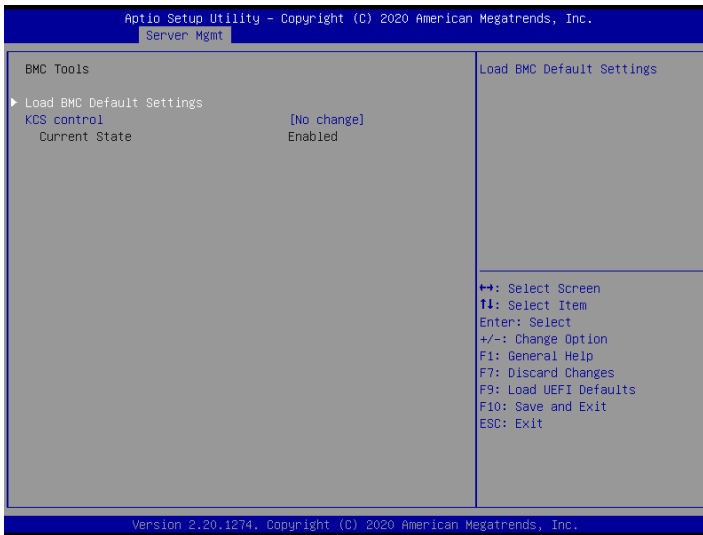

Load BMC Default Settings

Use this item to Load BMC Default Settings

KCS Control

Select this KCS interface state after POST end. If [Enabled] is selected, the BMC will remain KCS interface after POST stage. If [Disabled] is selected, the BMC will disable KCS interface after POST stage

3.5 Security

In this section, you may set or change the supervisor/user password for the system. For the user password, you may also clear it.

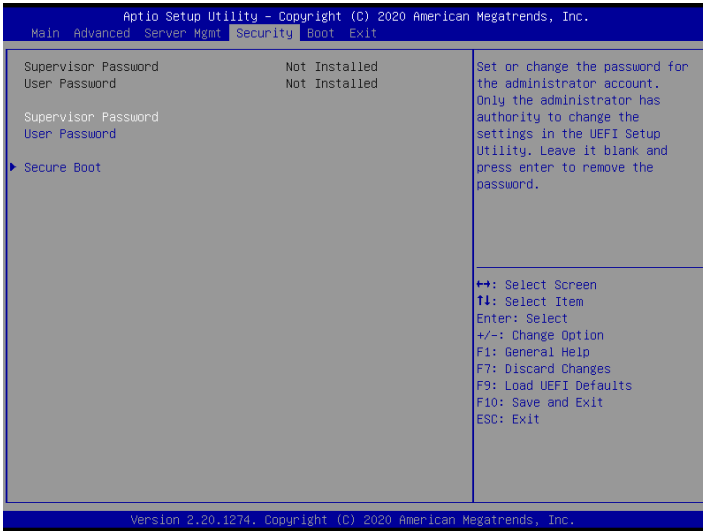

Supervisor Password

Set or change the password for the administrator account. Only the administrator has authority to change the settings in the UEFI Setup Utility. Leave it blank and press enter to remove the password.

User Password

Set or change the password for the user account. Users are unable to change the settings in the UEFI Setup Utility. Leave it blank and press enter to remove the password.

Secure Boot

Use this to enable or disable Secure Boot Control. The default value is [Disabled]. Enable to support Windows Server 2012 R2 or later versions Secure Boot.

Secure Boot Mode

Secure Boot mode selector: Standard/Custom. In Custom mode, Secure Boot Policy variables can be configured by a physically present user without full authentication.

3.5.1 Key Management

In this section, expert users can modify Secure Boot Policy variables without full authentication.

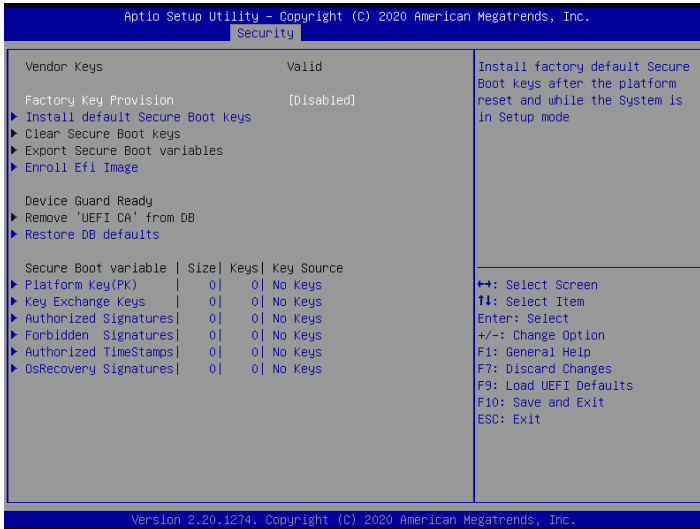

Factory Key Provision

Install factory default Secure Boot keys after the platform reset and while the System is in Setup mode.

Install Default Secure Boot Keys

Please install default secure boot keys if it's the first time you use secure boot.

Clear Secure Boot keys

Force System to Setup Mode - clear all Secure Boot Variables. Change takes effect after reboot.

Export Secure Boot variables

Copy NVRAM content of Secure Boot variables to files in a root folder on a file system device.

Enroll Efi Image

Allow the image to run in Secure Boot mode. Enroll SHA256 Hash certificate of a PE image into Authorized Signature Database (db).

Remove 'UEFI CA' from DB

Device Guard ready system must not list 'Microsoft UEFI CA' Certificate in Authorized Signature database (db).

Restore DB defaults

Restore DB variable to factory defaults.

Platform Key(PK)

Enroll Factory Defaults or load certificates from a file:

1. Public Key Certificate in:

- a) EFI_SIGNATURE_LIST
- b) EFI_CERT_X509 (DER)
- c) EFI_CERT_RSA2048 (bin)
- d) EFI_CERT_SHA256, 384, 512

2. Authenticated UEFI Variable

3. EFI PE/COFF Image(SHA256)

Key Source: Factory, External, Mixed

Key Exchange Keys

Enroll Factory Defaults or load certificates from a file:

1. Public Key Certificate in:

- a) EFI_SIGNATURE_LIST
- b) EFI_CERT_X509 (DER encoded)
- c) EFI_CERT_RSA2048 (bin)
- d) EFI_CERT_SHA256, 384, 512

2. Authenticated UEFI Variable

3. EFI PE/COFF Image(SHA256)

Key Source: Factory, External, Mixed

Authorized Signatures

Enroll Factory Defaults or load certificates from a file:

1. Public Key Certificate in:

- a) EFI_SIGNATURE_LIST
- b) EFI_CERT_X509 (DER encoded)
- c) EFI_CERT_RSA2048 (bin)
- d) EFI_CERT_SHA256, 384, 512

2. Authenticated UEFI Variable

3. EFI PE/COFF Image(SHA256)

Key Source: Factory, External, Mixed

Forbidden Signatures

Enroll Factory Defaults or load certificates from a file:

1. Public Key Certificate in:

- a) EFI_SIGNATURE_LIST
- b) EFI_CERT_X509 (DER encoded)
- c) EFI_CERT_RSA2048 (bin)
- d) EFI_CERT_SHA256, 384, 512

2. Authenticated UEFI Variable

3. EFI PE/COFF Image(SHA256)

Key Source: Factory, External, Mixed

Authorized TimeStamps

Enroll Factory Defaults or load certificates from a file:

1. Public Key Certificate in:

- a) EFI_SIGNATURE_LIST
- b) EFI_CERT_X509 (DER encoded)
- c) EFI_CERT_RSA2048 (bin)
- d) EFI_CERT_SHA256, 384, 512

2. Authenticated UEFI Variable

3. EFI PE/COFF Image(SHA256)

Key Source: Factory, External, Mixed

OsRecovery Signatures

Enroll Factory Defaults or load certificates from a file:

1. Public Key Certificate in:

- a) EFI_SIGNATURE_LIST
- b) EFI_CERT_X509 (DER encoded)
- c) EFI_CERT_RSA2048 (bin)
- d) EFI_CERT_SHA256, 384, 512

2. Authenticated UEFI Variable

3. EFI PE/COFF Image(SHA256)

Key Source: Default, External, Mixed, Test

3.6 Boot Screen

In this section, it will display the available devices on your system for you to configure the boot settings and the boot priority.

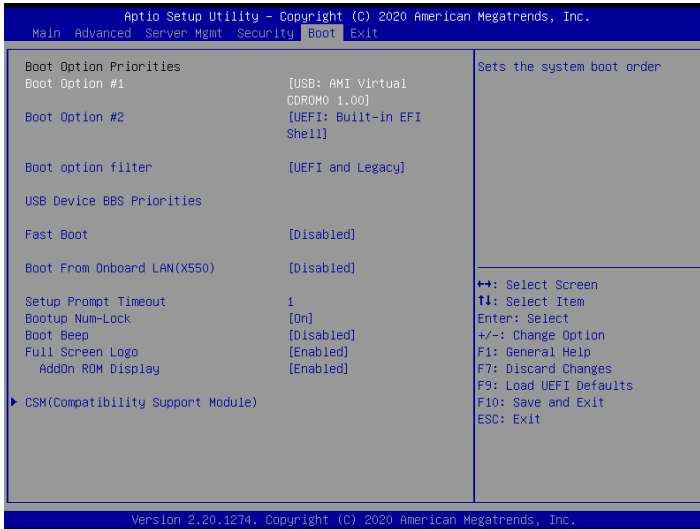

Boot Option #1

Use this item to set the system boot order.

Boot Option #2

Use this item to set the system boot order.

Boot Option Filter

This option controls Legacy/UEFI ROMs priority.

USB Device BBS Priorities

This page will show only when system install USB Storage.

Fast Boot

Fast Boot minimizes your computer's boot time. In fast mode you may not boot from an USB storage device. Ultra Fast mode is only supported by Windows 8.1 and the VBIOS must support UEFI GOP if you are using an external graphics card. Please notice that Ultra Fast mode will boot so fast that the only way to enter this UEFI Setup Utility is to Clear CMOS or run the Restart to UEFI utility in Windows.

Boot From Onboard LAN(X550)

Use this item to enable or disable the Boot From Onboard LAN feature.

Setup Prompt Timeout

This shows the number of seconds to wait for setup activation key. 65535(0XFFFF) means indefinite waiting.

Bootup Num-Lock

If this item is set to [On], it will automatically activate the Numeric Lock function after boot-up.

Boot Beep

Select whether the Boot Beep should be turned on or off when the system boots up. Please note that a buzzer is needed.

Full Screen Logo

Use this item to enable or disable OEM Logo. The default value is [Enabled].

AddOn ROM Display

Use this option to adjust AddOn ROM Display. If you enable the option “Full Screen Logo” but you want to see the AddOn ROM information when the system boots, please select [Enabled]. Configuration options: [Enabled] and [Disabled]. The default value is [Enabled].

3.6.1 CSM Parameters



CSM

Enable to launch the Compatibility Support Module. Please do not disable unless you're running a WHCK test. If you are using Windows 8.1 64-bit and all of your devices support UEFI, you may also disable CSM for faster boot speed.

Launch Other Storage OpROM Policy

Select UEFI only to run those that support UEFI option ROM only. Select Legacy only to run those that support legacy option ROM only. Select Do not launch to not execute both legacy and UEFI option ROM.

Launch Video OpROM Policy

Select UEFI only to run those that support UEFI option ROM only. Select Legacy only to run those that support legacy option ROM only. Select Do not launch to not execute both legacy and UEFI option ROM.

PCIe7 Slot OpROM

This option controls Legacy/UEFI ROMs priority.

3.7 Exit Screen

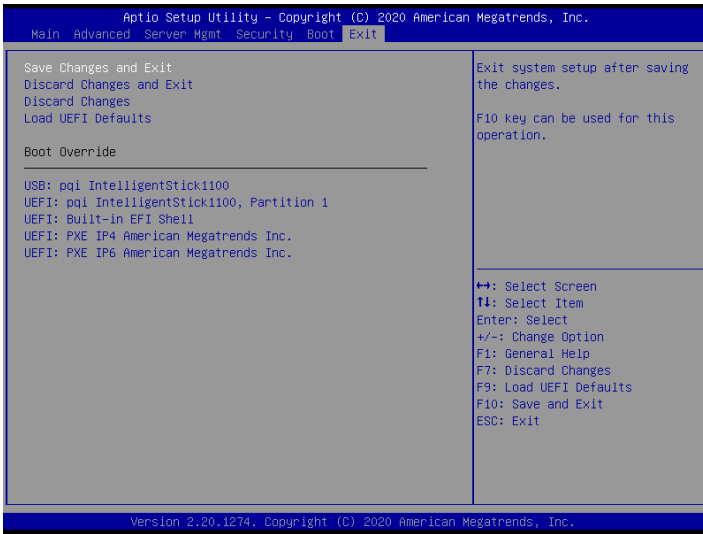

Save Changes and Exit

When you select this option, the following message “Save configuration changes and exit setup?” will pop-out. Press <F10> key or select [Yes] to save the changes and exit the UEFI SETUP UTILITY.

Discard Changes and Exit

When you select this option, the following message “Discard changes and exit setup?” will pop-out. Press <ESC> key or select [Yes] to exit the UEFI SETUP UTILITY without saving any changes.

Discard Changes

When you select this option, the following message “Discard changes?” will pop-out. Press <F7> key or select [Yes] to discard all changes.

Load UEFI Defaults

Load UEFI default values for all the setup questions. F9 key can be used for this operation.

Boot Override

These items displays the available devices. Select an item to start booting from the selected device.

Chapter 4 Software Support

4.1 Install Operating System

This motherboard supports various Microsoft® Windows® / Linux compliant. Because motherboard settings and hardware options vary, use the setup procedures in this chapter for general reference only. Refer to your OS documentation for more information.

**Please download the Intel® SATA Floppy Image driver from the ASRock Rack's website (www.asrockrack.com) to your USB drive or simply install the SATA driver from the Support CD while installing OS in SATA RAID mode.*

4.2 Support CD Information

The Support CD that came with the motherboard contains necessary drivers and useful utilities that enhance the motherboard's features.

4.2.1 Running The Support CD

To begin using the support CD, insert the CD into your CD-ROM drive. The CD automatically displays the Main Menu if "AUTORUN" is enabled in your computer. If the Main Menu does not appear automatically, locate and double click on the file "ASRSetup.exe" from the root folder in the Support CD to display the menu.

4.2.2 Drivers Menu

The Drivers Menu shows the available device's drivers if the system detects installed devices. Please install the necessary drivers to activate the devices.

4.2.3 Utilities Menu

The Utilities Menu shows the application softwares that the motherboard supports. Click on a specific item then follow the installation wizard to install it.

4.2.4 Contact Information

If you need to contact ASRock Rack or want to know more about ASRock Rack, welcome to visit ASRock Rack's website at <http://www.ASRockRack.com>; or you may contact your dealer for further information.

Chapter 5 Troubleshooting

5.1 Troubleshooting Procedures

Follow the procedures below to troubleshoot your system.



Always unplug the power cord before adding, removing or changing any hardware components. Failure to do so may cause physical injuries to you and damages to motherboard components.

1. Disconnect the power cable and check whether the PWR LED is off.
2. Unplug all cables, connectors and remove all add-on cards from the motherboard. Make sure that the jumpers are set to default settings.
3. Confirm that there are no short circuits between the motherboard and the chassis.
4. Install a CPU and fan on the motherboard, then connect the chassis speaker and power LED.

If there is no power...

1. Confirm that there are no short circuits between the motherboard and the chassis.
2. Make sure that the jumpers are set to default settings.
3. Check the settings of the 115V/230V switch on the power supply.
4. Verify if the battery on the motherboard provides ~3VDC. Install a new battery if it does not.

If there is no video...

1. Try replugging the monitor cables and power cord.
2. Check for memory errors.

If there are memory errors...

1. Verify that the DIMM modules are properly seated in the slots.
2. Use recommended DDR4 ECC SO-DIMMs.
3. If you have installed more than one DIMM modules, they should be identical with the same brand, speed, size and chip-type.
4. Try inserting different DIMM modules into different slots to identify faulty ones.
5. Check the settings of the 115V/230V switch on the power supply.

Unable to save system setup configurations...

1. Verify if the battery on the motherboard provides ~3VDC. Install a new battery if it does not.
2. Confirm whether your power supply provides adequate and stable power.

Other problems...

1. Try searching keywords related to your problem on ASRock Rack's FAQ page:
<http://www.asrockrack.com/support>

5.2 Technical Support Procedures

If you have tried the troubleshooting procedures mentioned above and the problems are still unsolved, please contact ASRock Rack's technical support with the following information:

1. Your contact information
2. Model name, BIOS version and problem type.
3. System configuration.
4. Problem description.

You may contact ASRock Rack's technical support at:
<http://www.asrockrack.com/support/tsd.asp>

5.3 Returning Merchandise for Service

For warranty service, the receipt or a copy of your invoice marked with the date of purchase is required. By calling your vendor or going to our RMA website (<http://event.asrockrack.com/tsd.asp>) you may obtain a Returned Merchandise Authorization (RMA) number.

The RMA number should be displayed on the outside of the shipping carton which is mailed prepaid or hand-carried when you return the motherboard to the manufacturer. Shipping and handling charges will be applied for all orders that must be mailed when service is complete.

This warranty does not cover damages incurred in shipping or from failure due to alteration, misuse, abuse or improper maintenance of products.

Contact your distributor first for any product related problems during the warranty period.