



OPEN

Industry Standard, Flexible Architecture

GREEN

Less Heat, Less Power Consumption

STABLE

Robust Design, Quality Parts

Stable and
Reliable Solution

Server/Workstation

Motherboard

D1541D4I-2L2T

D1541D4I

D1521D4I

User Manual

English



Version 1.0

Published February 2016

Copyright©2016 ASRock Rack Inc. All rights reserved.

Copyright Notice:

No part of this documentation may be reproduced, transcribed, transmitted, or translated in any language, in any form or by any means, except duplication of documentation by the purchaser for backup purpose, without written consent of ASRock Rack Inc.

Products and corporate names appearing in this documentation may or may not be registered trademarks or copyrights of their respective companies, and are used only for identification or explanation and to the owners' benefit, without intent to infringe.

Disclaimer:

Specifications and information contained in this documentation are furnished for informational use only and subject to change without notice, and should not be constructed as a commitment by ASRock Rack. ASRock Rack assumes no responsibility for any errors or omissions that may appear in this documentation.

With respect to the contents of this documentation, ASRock Rack does not provide warranty of any kind, either expressed or implied, including but not limited to the implied warranties or conditions of merchantability or fitness for a particular purpose.

In no event shall ASRock Rack, its directors, officers, employees, or agents be liable for any indirect, special, incidental, or consequential damages (including damages for loss of profits, loss of business, loss of data, interruption of business and the like), even if ASRock Rack has been advised of the possibility of such damages arising from any defect or error in the documentation or product.



This device complies with Part 15 of the FCC Rules. Operation is subject to the following two conditions:

- (1) this device may not cause harmful interference, and
- (2) this device must accept any interference received, including interference that may cause undesired operation.

CALIFORNIA, USA ONLY

The Lithium battery adopted on this motherboard contains Perchlorate, a toxic substance controlled in Perchlorate Best Management Practices (BMP) regulations passed by the California Legislature. When you discard the Lithium battery in California, USA, please follow the related regulations in advance.

“Perchlorate Material-special handling may apply, see www.dtsc.ca.gov/hazardouswaste/perchlorate”

ASRock Rack's Website: www.ASRockRack.com

Contact Information

If you need to contact ASRock Rack or want to know more about ASRock Rack, you're welcome to visit ASRock Rack's website at www.ASRockRack.com; or you may contact your dealer for further information.

ASRock Rack Incorporation

6F., No.37, Sec. 2, Jhongyang S. Rd., Beitou District,

Taipei City 112, Taiwan (R.O.C.)

Contents

Chapter 1 Introduction	1
1.1 Package Contents	1
1.2 Specifications	2
1.3 Unique Features	5
1.4 Motherboard Layout	6
1.5 Onboard LED Indicators	11
1.6 I/O Panel	12
1.7 Block Diagram	14
Chapter 2 Installation	16
2.1 Screw Holes	16
2.2 Pre-installation Precautions	16
2.3 Installation of Memory Modules (DIMM)	17
2.4 Expansion Slots (PCI Express Slots)	19
2.5 Jumper Setup	20
2.6 Onboard Headers and Connectors	21
2.7 Unit Identification purpose LED/Switch	28
2.8 Driver Installation Guide	28
2.9 Dual LAN and Teaming Operation Guide	29
2.10 M.2_SSD (NGFF) Module Installation Guide	30
Chapter 3 UEFI Setup Utility	32
3.1 Introduction	32
3.1.1 UEFI Menu Bar	32
3.1.2 Navigation Keys	33

3.2	Main Screen	34
3.3	Advanced Screen	35
3.3.1	ACPI Configuration	36
3.3.2	Configure Super IO Settings	37
3.3.3	Serial Port Console Redirection	38
3.3.4	CSM Configuration	41
3.3.5	USB Configuration	42
3.3.6	System Configuration	43
3.3.7	Hard Disk S.M.A.R.T Settings	45
3.3.8	3rd Storage Configuration	46
3.3.9	NVMe Configuration	47
3.3.9	H/W Monitor	48
3.3.10	WHEA Configuration	50
3.3.11	Instant Flash	52
3.4	IntelRCSetup	53
3.4.1	Processor Configuration	54
3.4.2	Advanced Power Management Configuration	56
3.4.3	Memory Configuration	58
3.4.4	IIO Configuration	59
3.4.5	PCH Configuration	60
3.4.6	Server ME Configuration	62
3.5	Server Mgmt	63
3.5.1	System Event Log	64
3.5.2	BMC Network Configuration	65

3.6	Security Screen	67
3.7	Boot Screen	68
3.8	Event Logs	70
3.9	Exit Screen	71
Chapter 4 Software Support		72
4.1	Install Operating System	72
4.2	Support CD Information	72
4.2.1	Running The Support CD	72
4.2.2	Drivers Menu	72
4.2.3	Utilities Menu	72
4.2.4	Contact Information	72
Chapter 5 Troubleshooting		73
5.1	Troubleshooting Procedures	73
5.2	Technical Support Procedures	75
5.3	Returning Merchandise for Service	75
Chapter 6: Net Framework Installation Guide		76
6.1	Installing .Net Framework 3.5.1 (For Server 2008 R2)	76

Chapter 1 Introduction

Thank you for purchasing ASRock Rack **D1541D4I-2L2T / D1541D4I / D1521D4I** motherboard, a reliable motherboard produced under ASRock Rack's consistently stringent quality control. It delivers excellent performance with robust design conforming to ASRock Rack's commitment to quality and endurance.

In this manual, chapter 1 and 2 contains introduction of the motherboard and step-by-step guide to the hardware installation. Chapter 3 and 4 contains the configuration guide to BIOS setup and information of the Support CD.



Because the motherboard specifications and the BIOS software might be updated, the content of this manual will be subject to change without notice. In case any modifications of this manual occur, the updated version will be available on ASRock Rack website without further notice. You may find the latest memory and CPU support lists on ASRock Rack website as well. ASRock Rack's Website: www.ASRockRack.com

*If you require technical support related to this motherboard, please visit our website for specific information about the model you are using.
<http://www.asrockrack.com/support/>*

1.1 Package Contents

- ASRock Rack D1521D4I / D1541D4I / D1541D4I-2L2T Motherboard (Mini-ITX Form Factor: 6.7-in x 6.7-in, 17.02 cm x 17.02 cm)
- Support CD
- User Manual
- 2 x Serial ATA (SATA)3 Cables (60cm)
- 1 x Mini SAS Cable (6G) (60cm)
- 1 x I/O Shield
- 1 x Screw for M.2 Socket



If any items are missing or appear damaged, contact your authorized dealer.

1.2 Specifications

D1521D4I / D1541D4I / D1541D4I-2L2T	
MB Physical Status	
Form Factor	Mini-ITX
Dimension	6.7" x 6.7" (17.02 cm x 17.02 cm)
Processor System	
CPU	Supports Intel® Xeon® D1541 / D1521 Processor
Chipset	Soc
System Memory	
Capacity	- 4x DDR4 DIMM slots - Supports up to 128GB DDR4 ECC RDIMM - Supports up to 64GB DDR4 ECC/non-ECC UDIMM
DIMM Sizes and Type per DIMM	- Non-ECC UDIMM :4GB, 8GB, 16GB - ECC UDIMM : 4GB, 8GB, 16GB - RDIMM : 4GB, 8GB, 16GB,32GB
Frequency	D1521D4I: - Non-ECC UDIMM : 1600, 1866, 2133MHz - ECC UDIMM : 1600, 1866, 2133MHz - RDIMM : 1600, 1866, 2133MHz D1541D4I / D1541D4I-2L2T: - Non-ECC UDIMM : 1600, 1866, 2133MHz, 2400MHz - ECC UDIMM : 1600, 1866, 2133MHz, 2400MHz - RDIMM : 1600, 1866, 2133MHz, 2400MHz
Voltage	1.2V
Expansion Slot	
PCIe 3.0 x 16	1 slot
M.2	1 slot (PCIe, support form factor: 2242/2280)
Storage	
SATA Controller	D1541 / D1521: 6 x SATA3 6Gb/s (4 port from mini SAS, 1 port supports SATA DOM)
Ethernet	
Interface	1000 /100 /10 Mbps
LAN Controller	D1521D4I / D1541D4I: - 2 x RJ45 GLAN by Intel® i210 D1541D4I-2L2T: - 2 x RJ45 GLAN by Intel® i210 2 x RJ45 10GLAN by Intel® X557-AT2 - Supports Wake-On-LAN - Supports Energy Efficient Ethernet 802.3az - Supports Dual LAN with Teaming function - Supports PXE

Management	
BMC Controller	ASPEED AST2400
IPMI Dedicated GLAN	1 x Realtek RTL8211E for dedicated management GLAN
Features	<ul style="list-style-type: none"> - Watch Dog - NMI - IPMI (Intelligent Platform Management Interface) v.2.0 - Virtual media over LAN function - KVM over LAN function
Graphics	
Controller	ASPEED AST2400
VRAM	DDR3 16MB SDRAM
Output	Supports D-Sub with max. resolution up to 1920x1200 @ 60Hz
Rear Panel I/O	
VGA Port	1 x D-Sub
USB 3.0 Port	2
LAN Port	<p>D1521D4I / D1541D4I:</p> <ul style="list-style-type: none"> - RJ45: 2x GLAN(by Intel® i210) - LAN Ports with LED (ACT/LINK LED and SPEED LED) <p>D1541D4I-2L2T:</p> <ul style="list-style-type: none"> - RJ45: 2x 10GLAN(by Intel® X557-AT2)+ 2x GLAN(by Intel® i210) - LAN Ports with LED (ACT/LINK LED and SPEED LED)
UID Button/UID LED	1
Internal Connector	
Auxiliary Panel Header	1 (include chassis intrusion, location button & LED, front LAN LED , system fault LED)
TPM Header	1
IPMB Header	1
COM Header	1
Fan Header	4 (ICPU/2Front/1Rear)
ATX Power	1 x (24-pin)
DC-IN Power	1 x (8pin 12V)
System BIOS	
BIOS Type	128Mb AMI UEFI Legal BIOS
BIOS Features	<ul style="list-style-type: none"> - Plug and Play (PnP) - ACPI 2.0 Compliance Wake Up Events - SMBIOS 2.8.0 Support - ASRock Rack Instant Flash

Hardware Monitor	
Temperature	<ul style="list-style-type: none"> - CPU Temperature Sensing - System Temperature Sensing - System Inlet Temperature Sensing
Fan	<ul style="list-style-type: none"> - CPU/Rear/Front Fan Tachometer - CPU Quiet Fan (Allow Chassis Fan Speed Auto-Adjust by CPU Temperature) - CPU/Rear/Front Fan Multi-Speed Control
Voltage	Voltage Monitoring: +12V, +5V, +3.3V, CPU Vcore, DRAM, 1.05V_PCH, +BAT, 3VSB, 5VSB
Support OS	
OS	<p>Microsoft® Windows®</p> <ul style="list-style-type: none"> - Server 2008 R2 SP1 (64 bit) - Server 2012 (64 bit) - Server 2012 R2 (64 bit) <p>Linux®</p> <ul style="list-style-type: none"> - CentOS 6.6 (32 / 64 bit) / 7.0 (64 bit) (only supports AHCI mode) - SUSE Enterprise Linux Server 11 SP3 (32 / 64 bit) / 12 (64 bit) - FreeBSD 10.1 (32 / 64 bit) - Fedora Core 22 (64 bit) - Ubuntu 15.04 (64 bit) / 15.10 (64 bit) (AHCI mode) - RedHat Enterprise Linux Server 6.6 (32 / 64 bit) / 7.0 (64 bit) <p>Virtual:</p> <ul style="list-style-type: none"> - VMWare ESXi 5.5/ ESXi 6.0 <p>* Please refer to our website for the latest OS support list.</p>
Environment	
Temperature	<p>Operation temperature: 10°C ~ 35°C / Non operation temperature: -40°C ~ 70°C</p>

* For detailed product information, please visit our website: <http://www.asrockrack.com>



This motherboard supports Wake from on Board LAN. To use this function, please make sure that the "Wake on Magic Packet from power off state" is enabled in Device Manager > Intel® Ethernet Connection > Power Management. And the "PCI Devices Power On" is enabled in UEFI SETUP UTILITY > Advanced > ACPI Configuration. After that, onboard LAN1&2 can wake up S5 under OS.



If you install Intel® LAN utility, this motherboard may fail Windows® Hardware Quality Lab (WHQL) certification tests. If you install the drivers only, it will pass the WHQL tests.

1.3 Unique Features

ASRock Instant Flash is a BIOS flash utility embedded in Flash ROM. This convenient BIOS update tool allows you to update system BIOS without entering operating systems first like MS-DOS or Windows[®]. With this utility, you can press the <F6> key during the POST or the <F2> key to enter into the BIOS setup menu to access ASRock Rack Instant Flash. Just launch this tool and save the new BIOS file to your USB flash drive, floppy disk or hard drive, then you can update your BIOS only in a few clicks without preparing an additional floppy diskette or other complicated flash utility. Please be noted that the USB flash drive or hard drive must use FAT32/16/12 file system.

1.4 Motherboard Layout

D1541D4I-2L2T

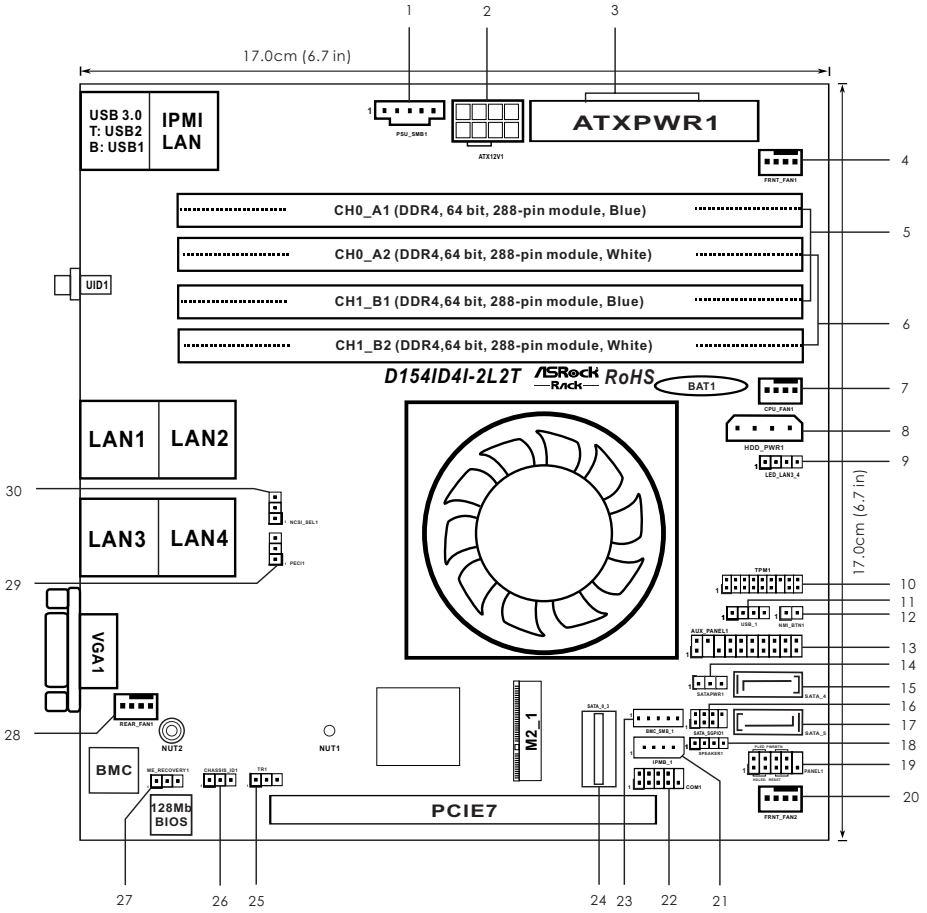

No.	Description
1	PSU SMBus (PSU_SMB1)
2	DC-IN 12V Power Connector (ATX12V1)*
3	ATX Power Connector (ATXPWR1)*
4	Front Fan Connector (FRNT_FAN1)
5	2 x 288-pin DDR4 DIMM Slots (CH0_A1, CH1_B1)
6	2 x 288-pin DDR4 DIMM Slots (CH0_A2, CH1_B2)
7	CPU Fan Connector (CPU_FAN1)
8	HDD Power Connector (HDD_PWR1)
9	LAN LED Connector (LED_LAN3_4)
10	TPM Header (TPM1)
11	USB 2.0 Header (USB_1)
12	Non Maskable Interrupt Button (NMI_BTN1)
13	Auxiliary Panel Header (AUX_PANEL1)
14	SATA DOM Power Jumper (SATAPWR1)
15	SATA3 Connector (SATA_4)
16	SATA SGPIO Connector (SATA_SGPIO1)
17	SATA3 Connector (SATA_5)
18	Speaker Header (SPEAKER1)
19	System Panel Header (PANEL1)
20	Front Fan Connector (FRNT_FAN2)
21	Intelligent Platform Management Bus header (IPMB_1)
22	COM Port Header (COM1)
23	BMC SMB Header (BMC_SMB1)
24	Mini SAS Connector (SATA_0_3)
25	Thermal Sensor Header (TR1)
26	Chassis ID Jumper (CHASSIS_ID1)
27	ME Recovery Jumper (ME_RECOVERY1)
28	Rear Fan Connector (REAR_FAN1)
29	CPU PECI Mode Jumper (PECI1)
30	NCSI Mode Jumper (NCSI_SEL1)

*Please use either the DC-IN 12V Power Connector (ATX12V1) or the ATX Power Connector (ATXPWR1) at one time. Do not connect them both simultaneously.

D1541D4I

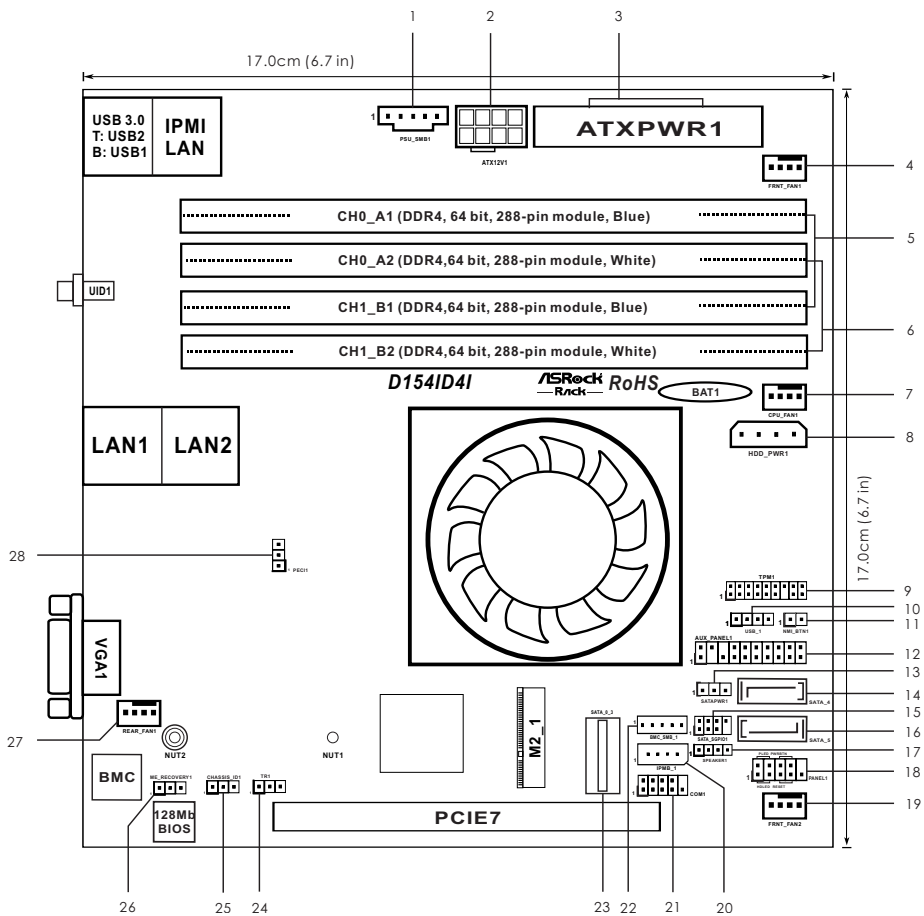

D1521D4I

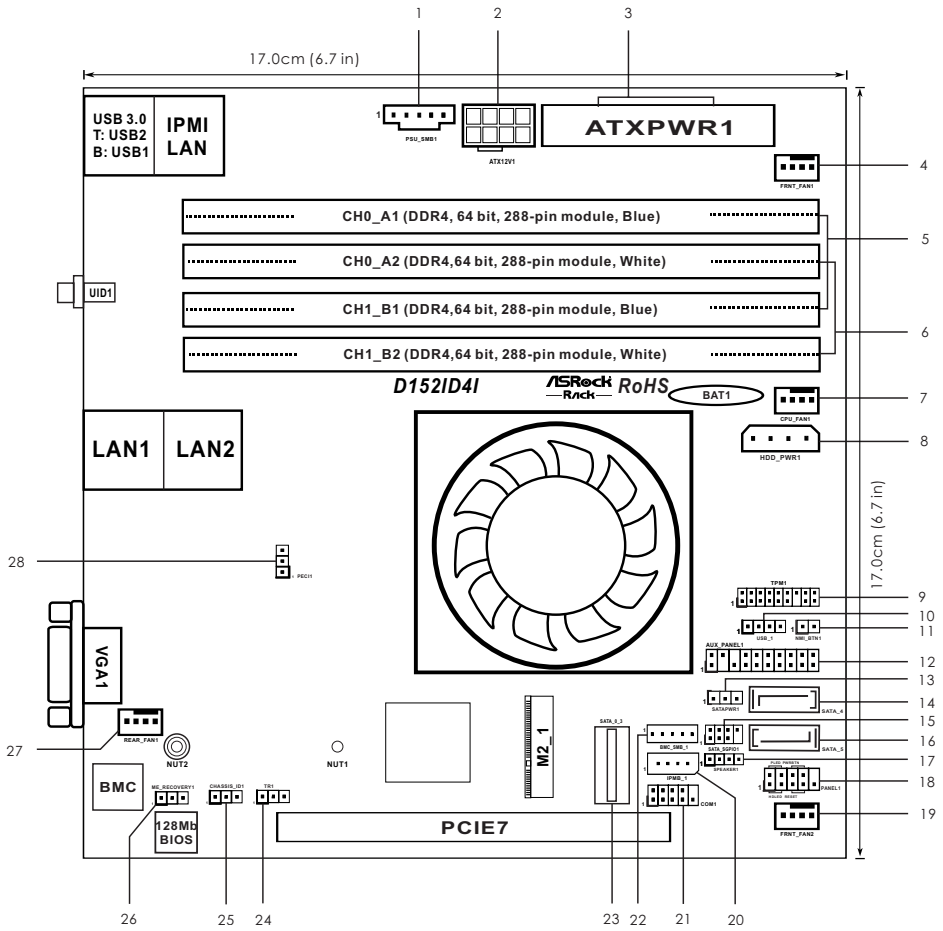

No.	Description
1	PSU SMBus (PSU_SMB1)
2	DC-IN 12V Power Connector (ATX12V1)*
3	ATX Power Connector (ATXPWR1)*
4	Front Fan Connector (FRNT_FAN1)
5	2 x 288-pin DDR4 DIMM Slots (CH0_A1, CH1_B1)
6	2 x 288-pin DDR4 DIMM Slots (CH0_A2, CH1_B2)
7	CPU Fan Connector (CPU_FAN1)
8	HDD Power Connector (HDD_PWR1)
9	TPM Header (TPM1)
10	USB 2.0 Header (USB_1)
11	Non Maskable Interrupt Button (NMI_BTN1)
12	Auxiliary Panel Header (AUX_PANEL1)
13	SATA DOM Power Jumper (SATAPWR1)
14	SATA3 Connector (SATA_4)
15	SATA SGPIO Connector (SATA_SGPIO1)
16	SATA3 Connector (SATA_5)
17	Speaker Header (SPEAKER1)
18	System Panel Header (PANEL1)
19	Front Fan Connector (FRNT_FAN2)
20	Intelligent Platform Management Bus header (IPMB_1)
21	COM Port Header (COM1)
22	BMC SMB Header (BMC_SMB1)
23	Mini SAS Connector (SATA_0_3)
24	Thermal Sensor Header (TR1)
25	Chassis ID Jumper (CHASSIS_ID1)
26	ME Recovery Jumper (ME_RECOVERY1)
27	Rear Fan Connector (REAR_FAN1)
28	CPU PECI Mode Jumper (PECI1)

*Please use either the DC-IN 12V Power Connector (ATX12V1) or the ATX Power Connector (ATXPWR1) at one time. Do not connect them both simultaneously.

1.5 Onboard LED Indicators

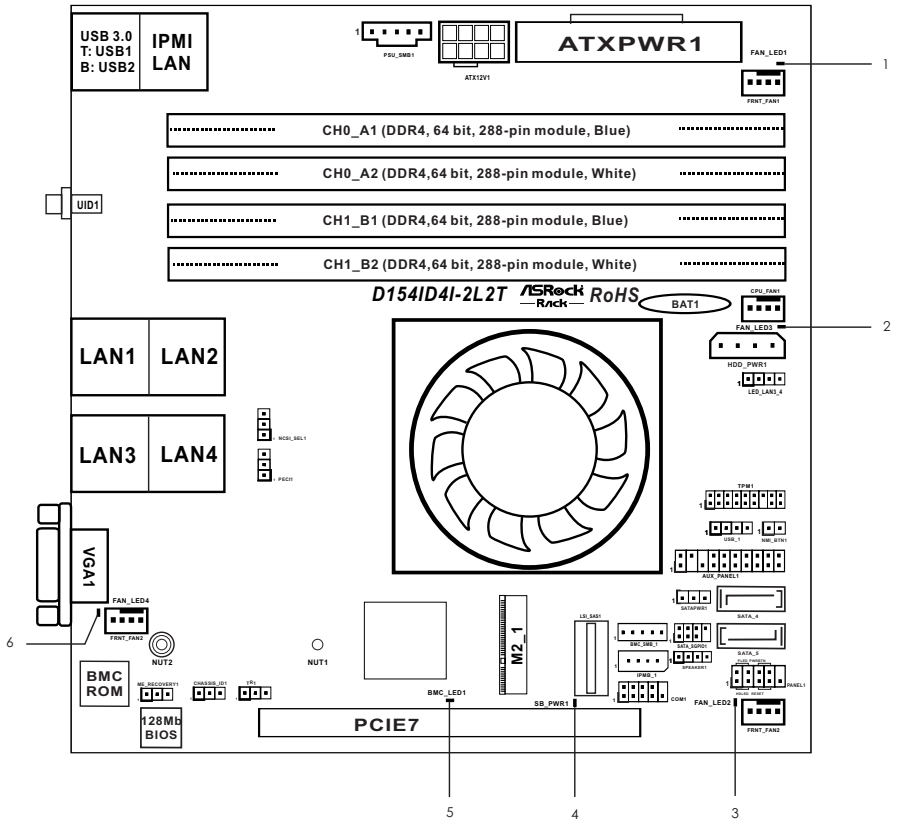

No.	Status	Description
1	Amber	Front_FAN1 failed
2	Amber	CPU_FAN1 failed
3	Amber	Front_FAN2 failed
4	Green	STB PWR ready
5	Green	BMC heartbeat LED
6	Amber	Rear_FAN1 failed

1.6 I/O Panel

D1541D4I-2L2T

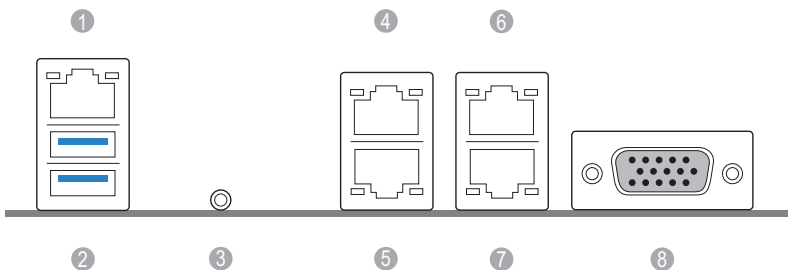

No.	Description	No.	Description
1	Dedicated IPMI LAN Port*	5	LAN RJ-45 Port (LAN1)*
2	USB 3.0 Ports (USB3_12)	6	10G LAN RJ-45 Port (LAN4)**
3	UID Switch/LED (UID_SW_LED1)	7	10G LAN RJ-45 Port (LAN3)**
4	LAN RJ-45 Port (LAN2)*	8	VGA Port (VGA1)

D1541D4I / D1521D4I

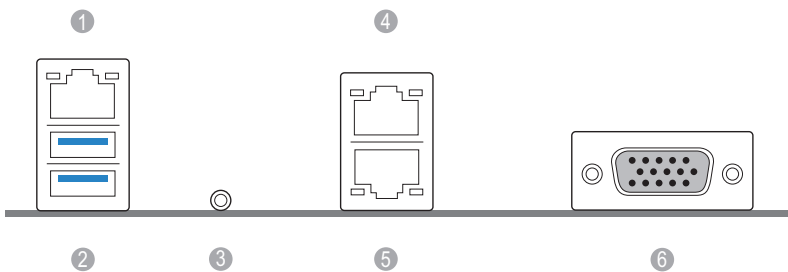

No.	Description	No.	Description
1	Dedicated IPMI LAN Port*	4	LAN RJ-45 Port (LAN2)*
2	USB 3.0 Ports (USB3_12)	5	LAN RJ-45 Port (LAN1)*
3	UID Switch/LED (UID_SW_LED1)	6	VGA Port (VGA1)

LAN Port LED Indications

*There are two LED next to the LAN port. Please refer to the table below for the LAN port LED indications.

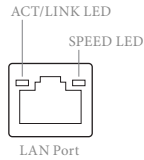

Dedicated IPMI / LAN1 / LAN2 LAN Port LED Indications

Activity / Link LED		Speed LED	
Status	Description	Status	Description
Off	No Link	Off	No Link
Blinking Yellow	Data Activity	Off	10M bps connection
On	Link	Yellow	100M bps connection
		Green	1G bps connection

**There are two LEDs on each LAN port. Please refer to the table below for the LAN port LED indications.

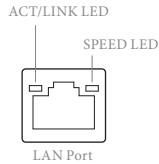

LAN Port (LAN3, LAN4) LED Indications

10G For D1541D4I-2L2T

Activity / Link LED		Speed LED	
Status	Description	Status	Description
Off	No Link	Off	100Mbps connection or no link
Blinking Green	Data Activity	Yellow	1Gbps connection
On	Link	Green	10Gbps connection

1.7 Block Diagram

D1541D4I-2L2T

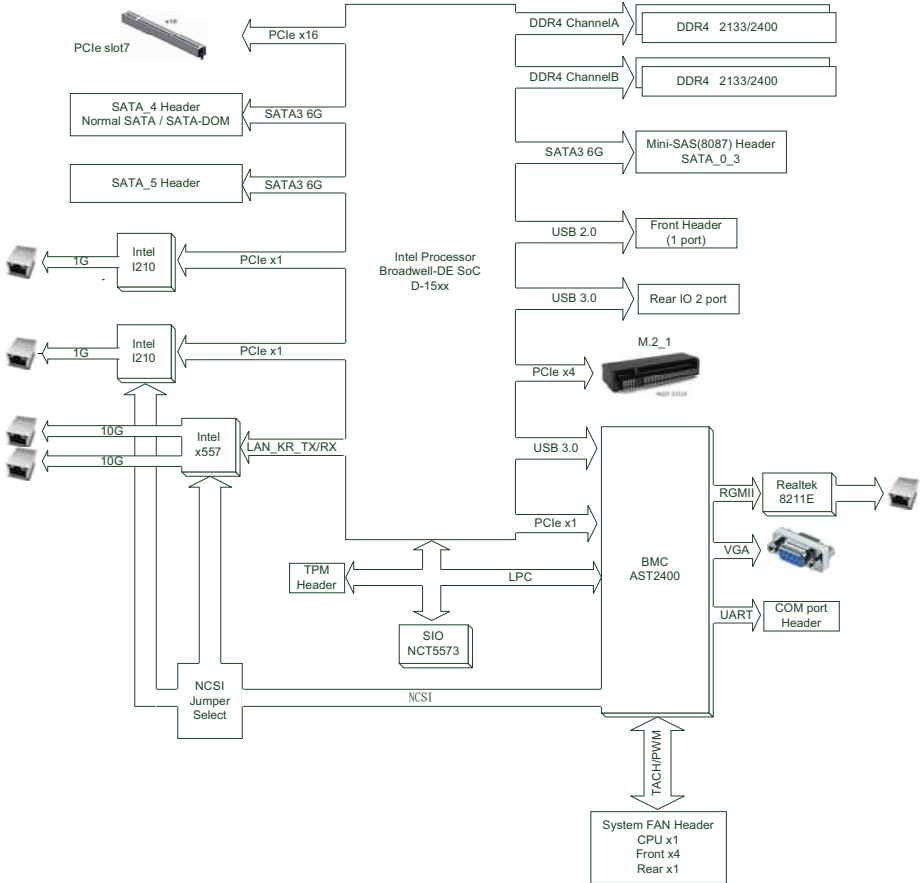

D1541D4I / D1521D4I

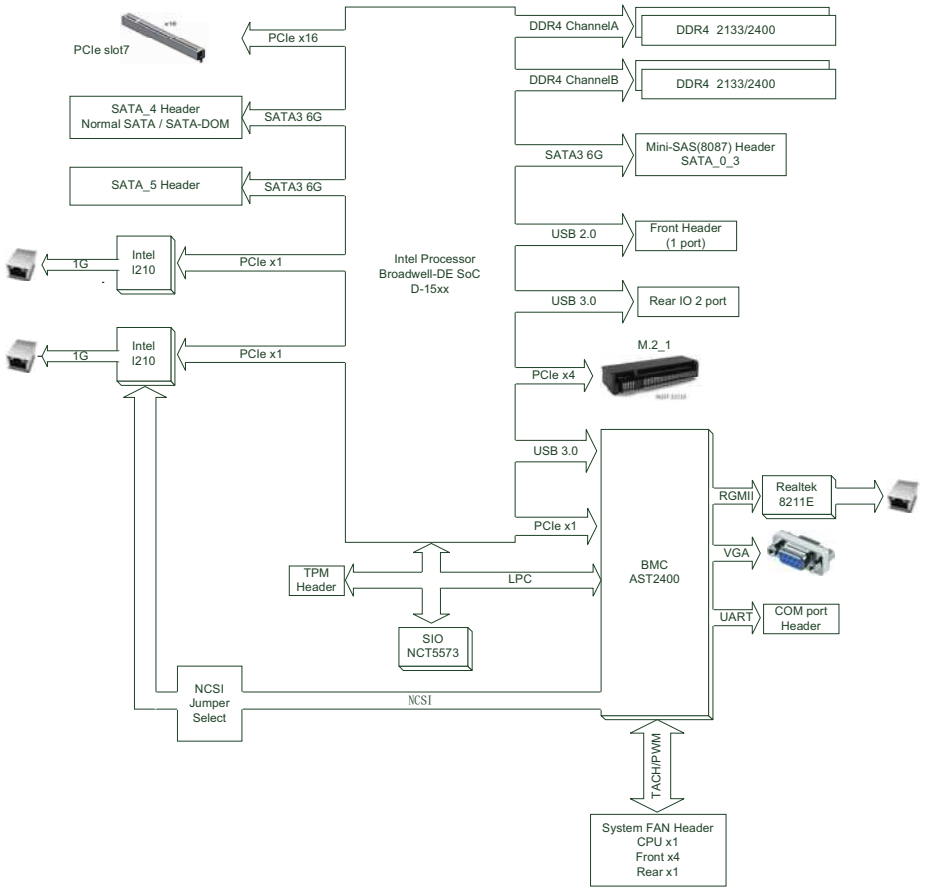

Chapter 2 Installation

This is a Mini-ITX form factor (6.7" x 6.7", 17.0 cm x 17.0 cm) motherboard. Before you install the motherboard, study the configuration of your chassis to ensure that the motherboard fits into it.



Make sure to unplug the power cord before installing or removing the motherboard. Failure to do so may cause physical injuries to you and damages to motherboard components.

2.1 Screw Holes

Place screws into the holes indicated by circles to secure the motherboard to the chassis.



Do not over-tighten the screws! Doing so may damage the motherboard.

2.2 Pre-installation Precautions

Take note of the following precautions before you install motherboard components or change any motherboard settings.

1. Unplug the power cord from the wall socket before touching any components.
2. To avoid damaging the motherboard's components due to static electricity, NEVER place your motherboard directly on the carpet or the like. Also remember to use a grounded wrist strap or touch a safety grounded object before you handle the components.
3. Hold components by the edges and do not touch the ICs.
4. Whenever you uninstall any component, place it on a grounded anti-static pad or in the bag that comes with the component.
5. When placing screws into the screw holes to secure the motherboard to the chassis, please do not over-tighten the screws! Doing so may damage the motherboard.



Before you install or remove any component, ensure that the power is switched off or the power cord is detached from the power supply. Failure to do so may cause severe damage to the motherboard, peripherals, and/or components.

2.3 Installation of Memory Modules (DIMM)

This motherboard provides four 288-pin DDR4 (Double Data Rate 4) DIMM slots, and supports Dual Channel Memory Technology.



1. For dual channel configuration, you always need to install identical (the same brand, speed, size and chip-type) DDR4 DIMM pairs.
2. It is not allowed to install a DDR, DDR2 or DDR3 memory module into a DDR4 slot; otherwise, this motherboard and DIMM may be damaged.
3. Please install the memory module on CH0_A1 for the first priority.
4. To activate Dual Channel Memory Technology, please follow the "Dual Channel Memory Configuration" table below.

Dual Channel Memory Configuration

Priority	CH0_A1 (Blue)	CH0_A2 (White)	CH1_B1 (Blue)	CH1_B2 (White)
1	Populated		Populated	
2	Populated	Populated	Populated	Populated

**Since installing three memory modules is NOT supported on this motherboard, we suggest not using this configuration.*



The DIMM only fits in one correct orientation. It will cause permanent damage to the motherboard and the DIMM if you force the DIMM into the slot at incorrect orientation.

1

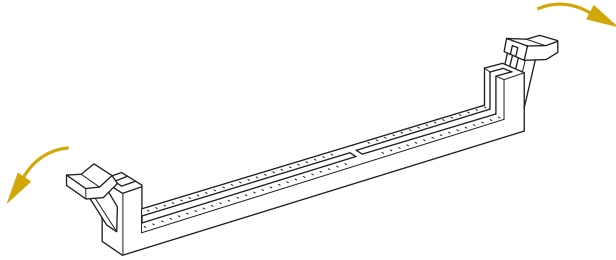

2

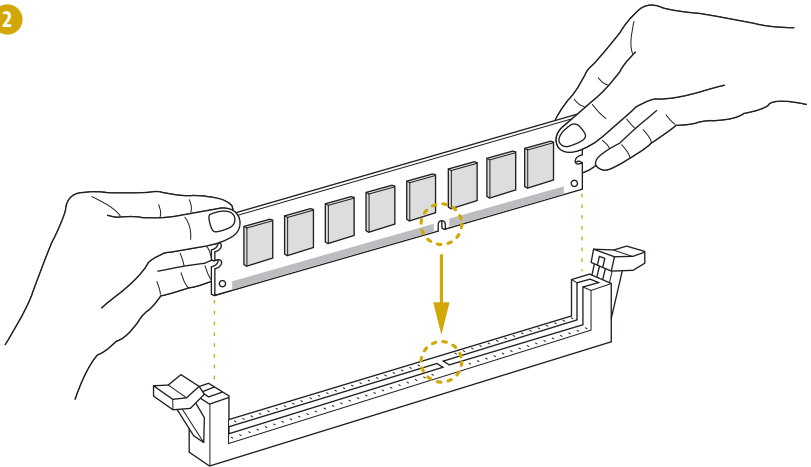

3

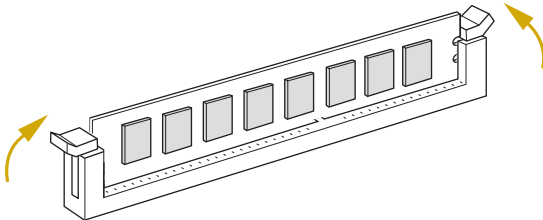

2.4 Expansion Slots (PCI Express Slots)

There is 1 PCI Express slots on this motherboard.

PCIe slot:

PCIe1 (PCIe 3.0 x16 slot) is used for PCI Express x16 lane width cards.

Installing an expansion card

- Step 1. Before installing an expansion card, please make sure that the power supply is switched off or the power cord is unplugged. Please read the documentation of the expansion card and make necessary hardware settings for the card before you start the installation.
- Step 2. Remove the system unit cover (if your motherboard is already installed in a chassis).
- Step 3. Remove the bracket facing the slot that you intend to use. Keep the screws for later use.
- Step 4. Align the card connector with the slot and press firmly until the card is completely seated on the slot.
- Step 5. Fasten the card to the chassis with screws.
- Step 6. Replace the system cover.

2.5 Jumper Setup

The illustration shows how jumpers are setup. When the jumper cap is placed on the pins, the jumper is “Short”. If no jumper cap is placed on the pins, the jumper is “Open”. The illustration shows a 3-pin jumper whose pin1 and pin2 are “Short” when a jumper cap is placed on these 2 pins.

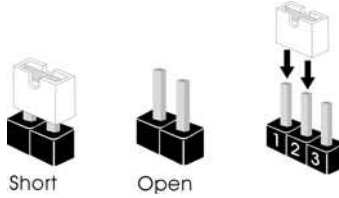

ME Recovery Jumper
(3-pin ME_RECOVERY1)



Normal Mode (Default)



ME Recovery Mode

SATA DOM Power
Jumper
(3-pin SATAPWR1)



SATA DOM (SATA_4)
requires 5V power supply



Normal SATA (Default)
SATA DOM (SATA_4) does
NOT require 5V power
supply

NCSI Mode Jumper
(3-pin NCSI_SEL1)

**Supports D1541D41-2L2T only*



NCSI is set LAN1 (i210)
(Default)



NCSI is set to LAN3 (X557)

CPU PECE Mode Jumper
(3-pin PECE1)



CPU PECE connected to PCH



CPU PECE connected to
BMC
(Default)

2.6 Onboard Headers and Connectors



Onboard headers and connectors are NOT jumpers. Do NOT place jumper caps over these headers and connectors. Placing jumper caps over the headers and connectors will cause permanent damage to the motherboard.

*You can see p.6~8 for motherboard layout.

Serial ATA3 Connectors

(SATA_4)

(SATA_5)



SATA_4



SATA_5

These two Serial ATA3 (SATA3) connectors support SATA data cables for internal storage devices. The current SATA3 interface allows up to 6.0 Gb/s data transfer rate.

Serial ATA3 DOM

Connector

(SATA_4)



SATA_4

The SATA3 DOM connector supports both a SATA DOM (Disk-On-Module) and a SATA data cable for internal storage device.

Mini SAS Connector

(SATA_0_3)

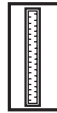

This connector supports MiniSAS-to-SATA or MiniSAS-to-MiniSAS data cables for internal storage devices with up to 6.0 Gb/s data transfer rate. Each connector is used to connect to four HDDs.

USB 2.0 Header

(4-pin USB_1)

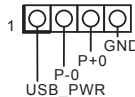

There is one USB 2.0 header on this motherboard, and it can support one USB 2.0 port.

Chassis Speaker Header
(4-pin SPEAKER1)

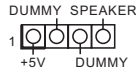

Please connect the chassis speaker to this header.

TPM Header
(17-pin TPM1)

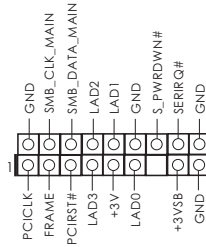

This connector supports Trusted Platform Module (TPM) system, which can securely store keys, digital certificates, passwords, and data. A TPM system also helps enhance network security, protects digital identities, and ensures platform integrity.

Serial General Purpose
Input/Output Headers
(7-pin SATA_SGPIO1)

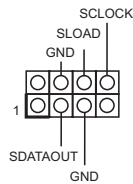

This header supports Serial Link interface for onboard SATA connections.

PSU SMBus
(PSU_SMB1)

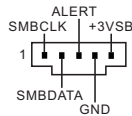

PSU SMBus monitors the status of the power supply, fan and system temperature.

System Panel Header (9-pin PANEL1)

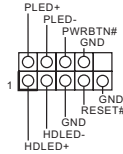

This header accommodates several system front panel functions.



PWRBTN (Power Switch):

Connect to the power switch on the chassis front panel. You may configure the way to turn off your system using the power switch.

RESET (Reset Switch):

Connect to the reset switch on the chassis front panel. Press the reset switch to restart the computer if the computer freezes and fails to perform a normal restart.

PLED (System Power LED):

Connect to the power status indicator on the chassis front panel. The LED is on when the system is operating. The LED is off when the system is in powered off (S5).

HDLED (Hard Drive Activity LED):

Connect to the hard drive activity LED on the chassis front panel. The LED is on when the hard drive is reading or writing data.

The front panel design may differ by chassis. A front panel module mainly consists of power switch, reset switch, power LED, hard drive activity LED, speaker and etc. When connecting your chassis front panel module to this header, make sure the wire assignments and the pin assignments are matched correctly.

Auxiliary Panel Header (18-pin AUX_PANEL1)

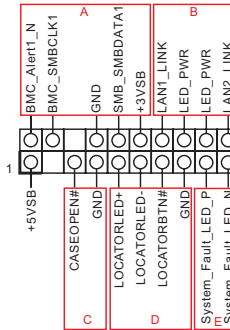

This header supports multiple functions on the front panel, including front panel SMB, internet status indicator.



A. Front panel SMBus connecting pin (6-1 pin FPSMB)

This header allows you to connect SMBus (System Management Bus) equipment. It can be used for communication between peripheral equipment in the system, which has slower transmission rates, and power management equipment.

B. Internet status indicator (2-pin LAN1_LED, LAN2_LED)

These two 2-pin headers allow you to use the Gigabit internet indicator cable to connect to the LAN status indicator. When this indicator flickers, it means that the internet is properly connected.

C. Chassis intrusion pin (2-pin CHASSIS)

This header is provided for host computer chassis with chassis intrusion detection designs. In addition, it must also work with external detection equipment, such as a chassis intrusion detection sensor or a microswitch. When this function is activated, if any chassis component movement occurs, the sensor will immediately detect it and send a signal to this header, and the system will then record this chassis intrusion event. The default setting is set to the CASEOPEN and GND pin; this function is off.

D. Locator LED (4-pin LOCATOR)

This header is for the locator switch and LED on the front panel.

E. System Fault LED (2-pin LOCATOR)

This header is for the Fault LED on the system.

Front and Rear Fan Connectors

(4-pin FRNT_FAN1)

(4-pin FRNT_FAN2)

(4-pin REAR_FAN1)

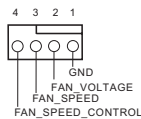

Please connect the fan cables to the fan connectors and match the black wire to the ground pin. All fans supports Fan Control.

CPU Fan Connectors (4-pin CPU_FAN1)

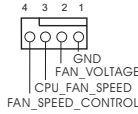

Please connect the CPU fan cable to the connector and match the black wire to the ground pin.

Though this motherboard provides a 4-Pin CPU fan (Quiet Fan) connector, 3-Pin CPU fans can still work successfully even without the fan speed control function. If you plan to connect a 3-Pin CPU fan to the CPU fan connector on this motherboard, please connect it to Pin 1-3.

**For more details, please refer to the Cooler QVL list on the ASRock Rack website.*

ATX Power Connector (24-pin ATXPWR1)

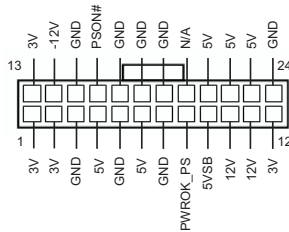

Please connect an ATX power supply to this connector.

Though this motherboard provides a 24-pin ATX power connector, it can still work if you adopt a traditional 20-pin ATX power supply. To use a 20-pin ATX power supply, please plug your power supply along Pin 1 and Pin 13.

DC-IN 12V Power Connector (8-pin ATX12V1)

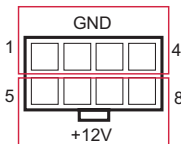

This motherboard provides one 8-pin DC-IN 12V power connector.

Intelligent Platform
Management Bus header
(4-pin IPMB_1)

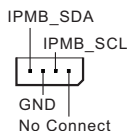

This 4-pin connector is used to provide a cabled baseboard or front panel connection for value added features and 3rd-party add-in cards, such as Emergency Management cards, that provide management features using the IPMB.

Non Maskable Interrupt
Button Header
(2-pin NMI_BTN1)



Please connect a NMI device to this header.

BMC SMB Headers
(5-pin BMC_SMB_1)

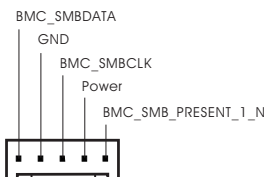

This header is used for the SM BUS devices.

LAN LED Connector
(LED_LAN3_4)

**Supports D1541D41-2L2T only*

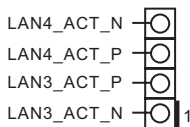

This 4-pin connector is used for the front LAN status indicator.

Thermal Sensor Header
(3-pin TR1)



Please connect the thermal sensor cable to either pin 1-2 or pin 2-3 and the other end to the device which you wish to monitor its temperature.

HDD Power Connector
(4-pin HDD_PWR1)

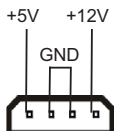

Please connect a 4 pin molex power cable to this connector to connect a HDD.

Serial Port Header
(9-pin COM1)

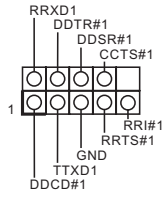

This COM header supports a serial port module.

2.7 Unit Identification purpose LED/Switch

With the UID button, You are able to locate the server you're working on from behind a rack of servers.

Unit Identification
purpose LED/Switch
(UID1)



When the UID button on the front or rear panel is pressed, the front/rear UID blue LED indicator will be turned on. Press the UID button again to turn off the indicator.

2.8 Driver Installation Guide

To install the drivers to your system, please insert the support CD to your optical drive first. Then, the drivers compatible to your system can be auto-detected and listed on the support CD driver page. Please follow the order from top to bottom to install those required drivers. Therefore, the drivers you install can work properly.

2.9 Dual LAN and Teaming Operation Guide

Dual LAN with Teaming enabled on this motherboard allows two single connections to act as one single connection for twice the transmission bandwidth, making data transmission more effective and improving the quality of transmission of distant images. Fault tolerance on the dual LAN network prevents network downtime by transferring the workload from a failed port to a working port.



The speed of transmission is subject to the actual network environment or status even with Teaming enabled.

Before setting up Teaming, please make sure whether your Switch (or Router) supports Teaming (IEEE 802.3ad Link Aggregation). You can specify a preferred adapter in Intel PROSet. Under normal conditions, the Primary adapter handles all non-TCP/IP traffic. The Secondary adapter will receive fallback traffic if the primary fails. If the Preferred Primary adapter fails, but is later restored to an active status, control is automatically switched back to the Preferred Primary adapter.

Step 1

From **Device Manager**, open the properties of a team.

Step 2

Click the **Settings** tab.

Step 3

Click the **Modify Team** button.

Step 4

Select the adapter you want to be the primary adapter and click the **Set Primary** button.

If you do not specify a preferred primary adapter, the software will choose an adapter of the highest capability (model and speed) to act as the default primary. If a failover occurs, another adapter becomes the primary. The adapter will, however, rejoin the team as a non-primary.

2.10 M.2_SSD (NGFF) Module Installation Guide

The M.2, also known as the Next Generation Form Factor (NGFF), is a small size and versatile card edge connector that aims to replace mPCIe and mSATA. This M.2_SSD (NGFF) Socket 3 can accommodate a M.2 PCI Express module up to Gen3 x4 (32 Gb/s) only.

Installing the M.2_SSD (NGFF) Module

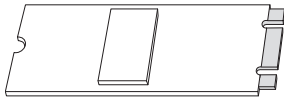

Step 1

Prepare a M.2_SSD (NGFF) module and the screw.

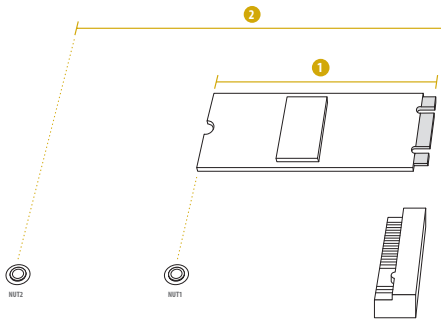

Step 2

Depending on the PCB type and length of your M.2_SSD (NGFF) module, find the corresponding nut location to be used.

No.	1	2
PCB Length	4.2cm	8cm
Module Type	Type 2242	Type 2280

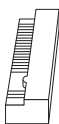

Step 3

Move the standoff based on the module type and length. The standoff is placed at the nut location D by default. Skip Step 3 and 4 and go straight to Step 5 if you are going to use the default nut. Otherwise, release the standoff by hand.



Step 4

Peel off the yellow protective film on the nut to be used. Hand tighten the standoff into the desired nut location on the motherboard.

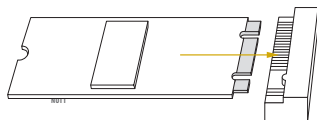
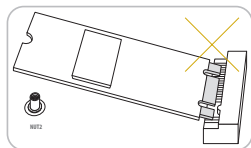

Step 5

Align and gently insert the M.2 (NGFF) SSD module into the M.2 slot. Please be aware that the M.2 (NGFF) SSD module only fits in one orientation.

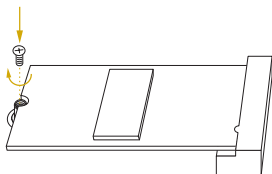

Step 6

Tighten the screw with a screwdriver to secure the module into place. Please do not overtighten the screw as this might damage the module.

M.2_SSD (NGFF) Module Support List

For the latest updates of M.2_SSD (NFGG) module support list, please visit our website for details: <http://www.asrockrack.com>

Chapter 3 UEFI Setup Utility

3.1 Introduction

This section explains how to use the UEFI SETUP UTILITY to configure your system. The UEFI chip on the motherboard stores the UEFI SETUP UTILITY. You may run the UEFI SETUP UTILITY when you start up the computer. Please press <F2> or during the Power-On-Self-Test (POST) to enter the UEFI SETUP UTILITY; otherwise, POST will continue with its test routines.

If you wish to enter the UEFI SETUP UTILITY after POST, restart the system by pressing <Ctrl> + <Alt> + <Delete>, or by pressing the reset button on the system chassis. You may also restart by turning the system off and then back on.



Because the UEFI software is constantly being updated, the following UEFI setup screens and descriptions are for reference purpose only, and they may not exactly match what you see on your screen.

3.1.1 UEFI Menu Bar

The top of the screen has a menu bar with the following selections:

Item	Description
Main	To set up the system time/date information
Advanced	To set up the advanced UEFI features
H/W Monitor	To display current hardware status
IntelRCSetup	For Intel CPU and chipset settings
Server Mgmt	To manage the server
Security	To set up the security features
Boot	To set up the default system device to locate and load the Operating System
Event Logs	For event log configuration
Exit	To exit the current screen or the UEFI SETUP UTILITY

Use <←> key or <→> key to choose among the selections on the menu bar, and then press <Enter> to get into the sub screen.

3.1.2 Navigation Keys

Please check the following table for the function description of each navigation key.

Navigation Key(s)	Function Description
← / →	Moves cursor left or right to select Screens
↑ / ↓	Moves cursor up or down to select items
+ / -	To change option for the selected items
<Tab>	Switch to next function
<Enter>	To bring up the selected screen
<PGUP>	Go to the previous page
<PGDN>	Go to the next page
<HOME>	Go to the top of the screen
<END>	Go to the bottom of the screen
<F1>	To display the General Help Screen
<F7>	Discard changes and exit the UEFI SETUP UTILITY
<F9>	Load optimal default values for all the settings
<F10>	Save changes and exit the UEFI SETUP UTILITY
<F12>	Print screen
<ESC>	Jump to the Exit Screen or exit the current screen

3.2 Main Screen

Once you enter the UEFI SETUP UTILITY, the Main screen will appear and display the system overview. The Main screen provides system overview information and allows you to set the system time and date.



3.3 Advanced Screen

In this section, you may set the configurations for the following items: ACPI Configuration, Configure Super IO Settings, Serial Port Console Redirection, CSM Parameters, USB Configuration, System Configuration, Hard Disk S.M.A.R.T Settings, 3rd Storage Configuration, NVMe Configuration, H/W Monitor, WHEA Configuration and Instant Flash.

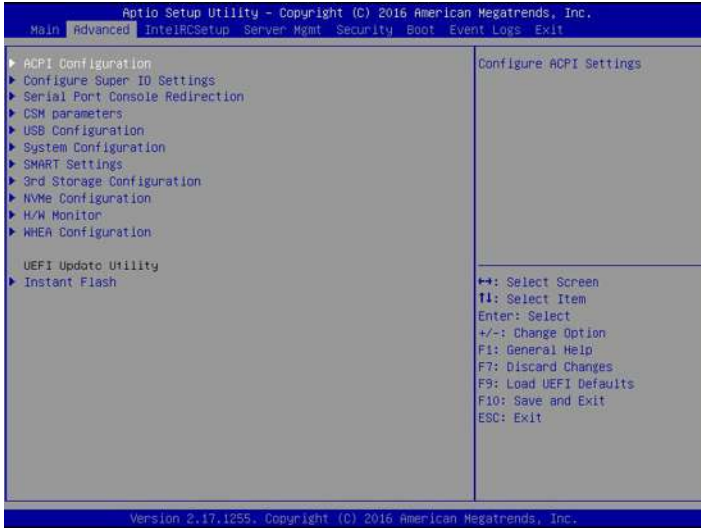

Setting wrong values in this section may cause the system to malfunction.

3.3.1 ACPI Configuration



PCIE Devices Power On

Use this item to enable or disable PCIE devices to turn on the system from the power-soft-off mode.

Ring-In Power On

Use this item to enable or disable Ring-In signals to turn on the system from the power-soft-off mode.

RTC Alarm Power On

Use this item to enable or disable RTC (Real Time Clock) to power on the system.

3.3.2 Configure Super IO Settings



Serial Port 1 Configuration

Use this item to configure the onboard serial port 1.

Select and enter the "Serial Port 1 Configuration" and you will see the followings:

Serial Port

Use this item to enable or disable the onboard serial port.

Serial Port Address

Use this item to select an optimal setting for Super IO device.

SOL Configuration

Use this item to set parameters of SOL.

Select and enter the "SOL Configuration" and you will see the followings:

SOL Port

Use this item to enable or disable the SOL port.

SOL Port Address

Use this item to select an optimal setting for Super IO device.

3.3.3 Serial Port Console Redirection



COM1 / SOL

Console Redirection

Use this option to enable or disable Console Redirection. If this item is set to Enabled, you can select a COM Port to be used for Console Redirection.

Console Redirection Settings

Use this option to configure Console Redirection Settings, and specify how your computer and the host computer to which you are connected exchange information.

Terminal Type

Use this item to select the preferred terminal emulation type for out-of-band management. It is recommended to select [VT-UTF8].

Option	Description
VT100	ASCII character set
VT100+	Extended VT100 that supports color and function keys
VT-UTF8	UTF8 encoding is used to map Unicode chars onto 1 or more bytes
ANSI	Extended ASCII character set

Bits Per Second

Use this item to select the serial port transmission speed. The speed used in the host

computer and the client computer must be the same. Long or noisy lines may require lower transmission speed. The options include [9600], [19200], [57600], [38400] and [115200].

Data Bits

Use this item to set the data transmission size. The options include [7] and [8] (Bits).

Parity

Use this item to select the parity bit. The options include [None], [Even], [Odd], [Mark] and [Space].

Stop Bits

The item indicates the end of a serial data packet. The standard setting is [1] Stop Bit. Select [2] Stop Bits for slower devices.

Flow Control

Use this item to set the flow control to prevent data loss from buffer overflow. When sending data, if the receiving buffers are full, a "stop" signal can be sent to stop the data flow. Once the buffers are empty, a "start" signal can be sent to restart the flow. Hardware flow uses two wires to send start/stop signals. The options include [None] and [Hardware RTS/CTS].

VT-UTF8 Combo Key Support

Use this item to enable or disable the VT-UTF8 Combo Key Support for ANSI/VT100 terminals.

Recorder Mode

Use this item to enable or disable Recorder Mode to capture terminal data and send it as text messages.

Resolution 100x31

Use this item to enable or disable extended terminal resolution support.

Legacy OS Redirection Resolution

Use this item to select the number of rows and columns used in legacy OS redirection.

Putty Keypad

Use this item to select Function Key and Keypad on Putty.

Redirection After BIOS POST

If the [LoadBooster] is selected, legacy console redirection is disabled before booting to legacy OS. If [Always Enabled] is selected, legacy console redirection is enabled for legacy OS. The default value is [Always Enabled].

Legacy Console Redirection**Legacy Console Redirection Settings**

Use this option to configure Legacy Console Redirection Settings.

Legacy Serial Redirection Port

Use this item to select a COM port to display redirection of Legacy OS and Legacy OPROM

Messages.

Serial Port for Out-of-Band Management/Windows Emergency Management Services (EMS)

Console Redirection

Use this option to enable or disable Console Redirection. If this item is set to Enabled, you can select a COM Port to be used for Console Redirection.

Console Redirection Settings

Use this option to configure Console Redirection Settings, and specify how your computer and the host computer to which you are connected exchange information.

Out-of-Band Mgmt Port

Microsoft Windows Emergency Management Services (EMS) allows for remote management of a Windows Server OS through a serial port.

Out-of-Band Mgmt Port

Microsoft Windows Emergency Management Services (EMS) allows for remote management of a Windows Server OS through a serial port.

Terminal Type

Use this item to select the preferred terminal emulation type for out-of-band management. It is recommended to select [VT-UTF8].

Option	Description
VT100	ASCII character set
VT100+	Extended VT100 that supports color and function keys
VT-UTF8	UTF8 encoding is used to map Unicode chars onto 1 or more bytes
ANSI	Extended ASCII character set

Bits Per Second

Use this item to select the serial port transmission speed. The speed used in the host computer and the client computer must be the same. Long or noisy lines may require lower transmission speed. The options include [9600], [19200], [57600] and [115200].

Flow Control

Use this item to set the flow control to prevent data loss from buffer overflow. When sending data, if the receiving buffers are full, a "stop" signal can be sent to stop the data flow. Once the buffers are empty, a "start" signal can be sent to restart the flow. Hardware flow uses two wires to send start/stop signals. The options include [None], [Hardware RTS/CTS], and [Software Xon/Xoff].

Data Bits

Parity

Stop Bits

3.3.4 CSM Configuration



Boot Option Filter

This option controls Legacy/UEFI ROMs priority.

Launch Storage OpROM Policy

Select UEFI only to run those that support UEFI option ROM only. Select Legacy only to run those that support legacy option ROM only. Select Do not launch to not execute both legacy and UEFI option ROM.

PCIE7 Slot OpROM

Use this item to select PCIE7 Option ROM policy.

3.3.5 USB Configuration



Intel USB3.0 Mode

Use this item to select the mode of operation of Intel USB 3.0 controller. Configuration options: [Enabled], [Disabled], [Auto] and [Smart Auto]. If [Auto] is selected, all USB ports work as USB3.0 after boot to OS. If [Smart Auto] is selected, all USB ports work as USB3.0 after boot to OS and work as USB2.0 in deep sleep stages.

Legacy USB 3.0 Support

Use this option to enable or disable legacy support for USB devices. The default value is [Enabled].

3.3.6 System Configuration

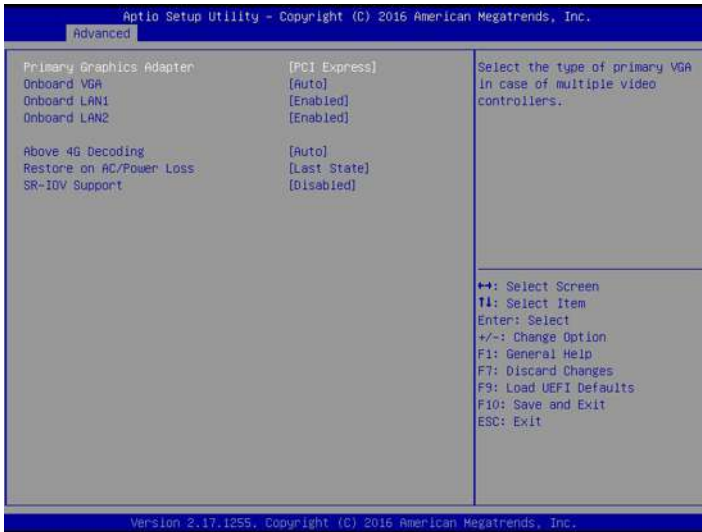

Primary Graphics Adapter

Use this item to select the type and primary VGA in case of multiple video controllers.

Onboard VGA

Use this to enable or disable the Onboard VGA function. The default value is [Auto].

Onboard LAN1

This allows you to enable or disable the Onboard LAN1 features.

Onboard LAN2

This allows you to enable or disable the Onboard LAN2 features.

Onboard LAN3 & LAN4 *(For D1541D4I-2L2T only)*

This allows you to enable or disable the Onboard LAN3 & LAN4 features.

Above 4G Decoding

Enable or disable 64bit capable Devices to be decoded in Above 4G Address Space (only if the system supports 64 bit PCI decoding).

Restore on AC/Power Loss

This allows you to set the power state after an unexpected AC/power loss. If [Power Off]

is selected, the AC/power remains off when the power recovers. If [Power On] is selected, the AC/power resumes and the system starts to boot up when the power recovers. If [Last State] is selected, it will recover to the state before AC/power loss.

SR-IOV Support

If system has SR-IOV capable PCIe Devices, this option Enables or Disables Single Root IO Virtualization Support.

3.3.7 Hard Disk S.M.A.R.T Settings



Hard Disk S.M.A.R.T.

Use this item to enable or disable the S.M.A.R.T. (Self-Monitoring, Analysis, and Reporting Technology) feature. Configuration options: [Disabled] and [Enabled].

3.3.8 3rd Storage Configuration



In this section, you may set the configurations or see the information of the connected 3rd storage device.

3.3.9 NVMe Configuration



The NVMe Configuration displays the NVMe controller and Drive information.

3.3.9 H/W Monitor

In this section, it allows you to monitor the status of the hardware on your system, including the parameters of the CPU temperature, motherboard temperature, CPU fan speed, chassis fan speed, and the critical voltage.

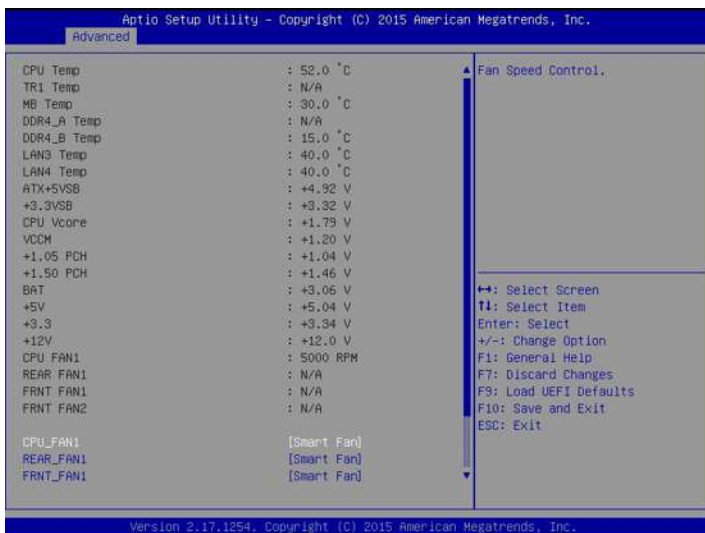

CPU_FAN1

This allows you to set the CPU fan1's speed. The default value is [Smart Fan].

REAR_FAN1

This allows you to set the rear fan 1's speed. The default value is [Smart Fan].

FRNT_FAN1

This allows you to set the front fan 1's speed. The default value is [Smart Fan].

FRNT_FAN2

This allows you to set the front fan 2's speed. The default value is [Smart Fan].

Smart Fan Control

This allows you to set the Smart fan's level speed.

Smart Fan Duty Control

Smart Fan Duty x (x means 1 to 11 stage)

This allows you to set duty cycle for each stage.

Smart Fan Temp Control

Smart Fan Temp x (x means 1 to 11 stage)

This allows you to set temperature for each stage.

Watch Dog Timer

This allows you to enable or disable the Watch Dog Timer. The default value is [Disabled].

3.3.10 WHEA Configuration

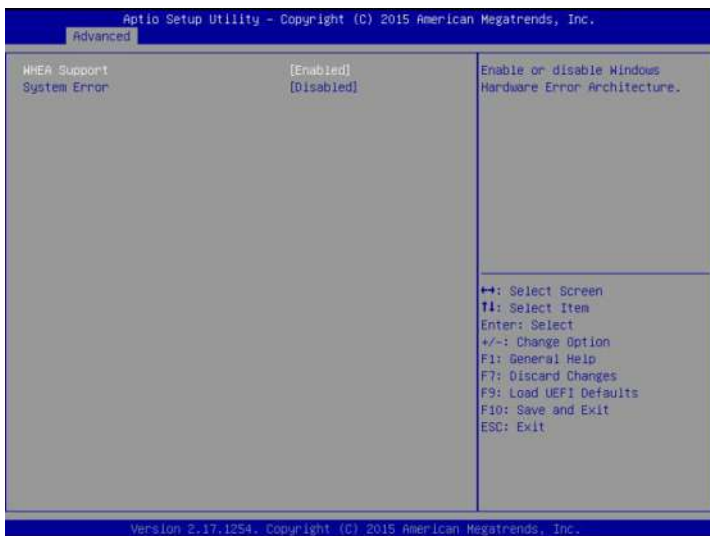

WHEA Support

Use this item to enable or disable Windows Hardware Error Architecture.

System Error

Use this item to enable or disable System Error feature. When it is set to [Enabled], you can configure Memory Error and PCIe Error log features.

Memory Error

Memory enabling and logging setup option.

Correctable Error Threshold

Correctable Error Threshold (1 - 32767) used for sparing, tagging, and leaky bucket.

PCIe Error

PCIe enabling and logging setup option.

Corrected Error Enable

Use this item to enable or disable PCIe Correctable errors.

Uncorrected Error Enable

Use this item to enable or disable PCIe Uncorrectable errors.

Fatal Error Enable

Use this item to enable or disable PCIe Fatal errors.

3.3.11 Instant Flash

Instant Flash is a UEFI flash utility embedded in Flash ROM. This convenient UEFI update tool allows you to update system UEFI without entering operating systems first like MS-DOS or Windows. Just save the new UEFI file to your USB flash drive, floppy disk or hard drive and launch this tool, then you can update your UEFI only in a few clicks without preparing an additional floppy diskette or other complicated flash utility. Please be noted that the USB flash drive or hard drive must use FAT32/16/12 file system. If you execute Instant Flash utility, the utility will show the UEFI files and their respective information. Select the proper UEFI file to update your UEFI, and reboot your system after the UEFI update process is completed.

3.4 IntelRCSetup

In this section, you may set the configurations for the following items: Processor Configuration, Advanced Power Management Configuration, Memory Configuration, IIO Configuration, PCH Configuration and Server ME Configuration.

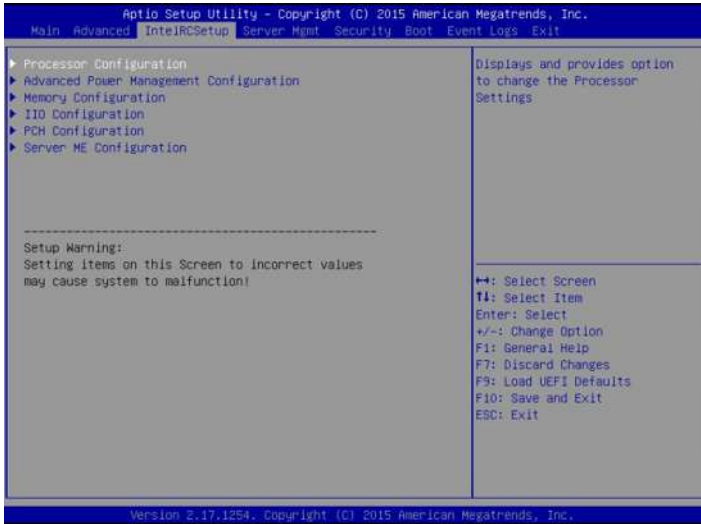

3.4.1 Processor Configuration

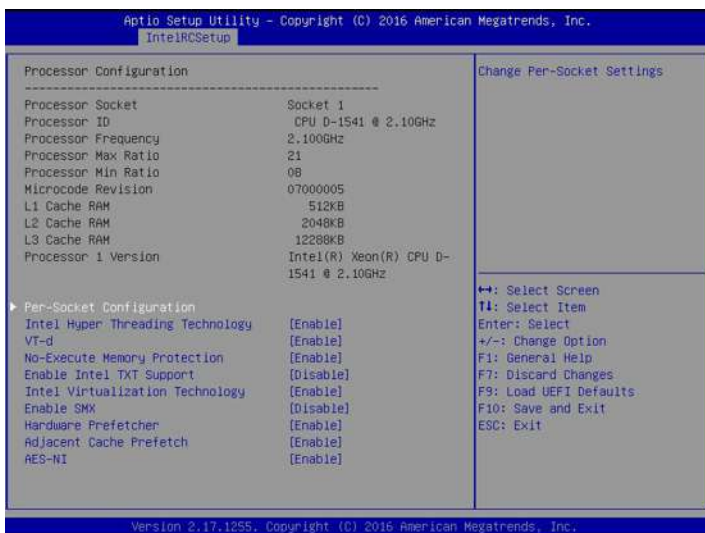

Per-Socket Configuration

Change Per-Socket Settings.

CPU Socket 1 Configuration

Active Processor Cores

Enter the number of cores to be enabled. 0 means all cores.

Intel Hyper Threading Technology

Intel Hyper Threading Technology allows multiple threads to run on each core, so that the overall performance on threaded software is improved.

VT-d

Intel® Virtualization Technology for Directed I/O helps your virtual machine monitor better utilize hardware by improving application compatibility and reliability, and providing additional levels of manageability, security, isolation, and I/O performance.

No-Execute Memory Protection

Processors with No-Execution Memory Protection Technology may prevent certain classes of malicious buffer overflow attacks.

Enable Intel TXT Support

Enable Intel Trusted Execution Technology configuration. Please disable "EX DFX Features" when TXT is enabled.

Intel Virtualization Technology

Intel Virtualization Technology allows a platform to run multiple operating systems and applications in independent partitions, so that one computer system can function as multiple virtual systems.

Enable SMX

Use this item to enable Safer Mode Extensions.

Hardware Prefetcher

Automatically prefetch data and code for the processor. Enable for better performance.

Adjacent Cache Prefetch

Automatically prefetch the subsequent cache line while retrieving the currently requested cache line. Enable for better performance.

AES-NI

Use this item to enable or disable AES-NI support.

3.4.2 Advanced Power Management Configuration



Intel SpeedStep Technology

Intel SpeedStep technology is Intel's new power saving technology. Processors can switch between multiple frequencies and voltage points to enable power saving. The default value is [Enabled]. Configuration options: [Enabled] and [Disabled]. If you install Windows® Vista™ / 7 / 8 and want to enable this function, please set this item to [Enabled]. This item will be hidden if the current CPU does not support Intel(R) SpeedStep technology.



Please note that enabling this function may reduce CPU voltage and lead to system stability or compatibility issues with some power supplies. Please set this item to [Disabled] if above issues occur.

Intel Turbo Boost Technology

Use this item to enable or disable Intel Turbo Boost Technology. Turbo Boost allows processor cores to run faster than marked frequency in specific conditions. The default value is [Enabled].

Package C State Support

Enable CPU, PCIe, Memory, Graphics C State Support for power saving.

CPU C3 State Support

Enable C3 sleep state for lower power consumption.

CPU C6 State Support

Enable C6 deep sleep state for lower power consumption.

CPU Thermal Throttling

Enable CPU internal thermal control mechanisms to keep the CPU from overheating.

3.4.3 Memory Configuration



Enforce POR

Enable to enforce POR restrictions for DDR4 frequency and voltage programming.

DRAM Frequency

If [Auto] is selected, the motherboard will detect the memory module(s) inserted and assign the appropriate frequency automatically.

ECC Support

Use this item to enable or disable DDR ECC Support.

Memory Information

Displays memory topology with DIMM population information.

Memory Map

Set memory mapping settings.

Channel Interleaving

Select to configure Channel Interleaving settings.

Rank Interleaving

Select to configure Rank Interleaving settings.

3.4.4 IIO Configuration



PCI-E Link Width

This allows you to select PCI-E Link Width. The default value is [x16].

PCI-E Link Speed

This allows you to select PCI-E Link Speed. The default value is [Auto].

PCI-E ASPM Support

This option enables or disables the ASPM support for all downstream devices.

3.4.5 PCH Configuration



PCH SATA Configuration

SATA devices and settings

SATA Controller

Use this item to enable or disable SATA Controller.

SATA Mode Selection

Identify the SATA port is connected to Solid State Drive or Hard Disk Drive.

SATA Aggressive Link Power Mgmt

Use this item to enable or disable SALP.

SATA Port 0 / 1 / 2 / 3 / 4 / 5

Hot Plug

Designates this port as Hot Pluggable.

Configure as External SATA

External SATA configuration.

Spin Up Device

If enabled for any of ports, Staggered Spin Up will be performed and only the drives which have this option enabled will spin up at boot. Otherwise all drives spin up at boot.

SATA Device Type

Identify the SATA port connected to Solid State Drive or Hard Disk Drive.

3.4.6 Server ME Configuration



Spread Spectrum

Use this item to select spread spectrum mode.

3.5 Server Mgmt



Wait For BMC

Wait For BMC response for specified time out. In PILOTII, BMC starts at the same time when BIOS starts during AC power ON. It takes around 30 seconds to initialize Host to BMC interfaces.

3.5.1 System Event Log



SEL Components

Change this to enable or disable all features of System Event Logging during boot.

Erase SEL

Use this to choose options for erasing SEL.

When SEL is Full

Use this to choose options for reactions to a full SEL.

Log EFI Status Codes

Use this item to disable the logging of EFI Status Codes or log only error code or only progress or both.

3.5.2 BMC Network Configuration

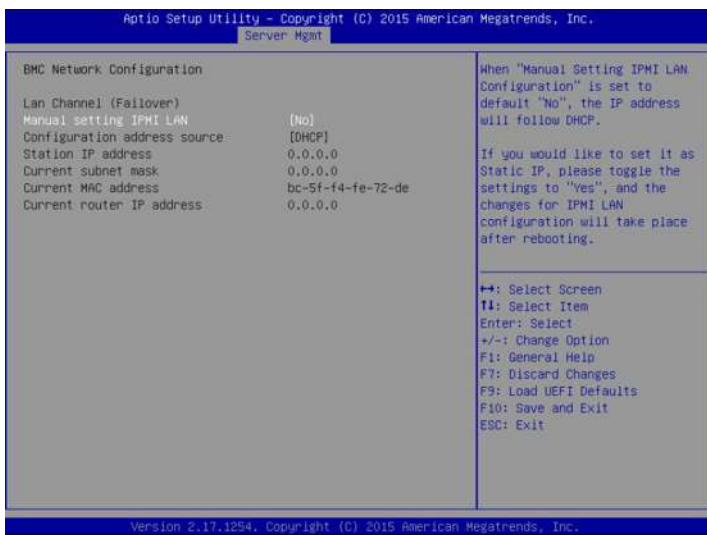

Lan Channel (Failover)

Manual setting IPMI LAN

If [No] is selected, the IP address is assigned by DHCP. If you prefer using a static IP address, toggle to [Yes], and the changes take effect after the system reboots. The default value is [No].

Configuration Address Source

Select to configure BMC network parameters statically or dynamically (by BIOS or BMC). Configuration options: [Static] and [DHCP].

Static: Manually enter the IP Address, Subnet Mask and Gateway Address in the BIOS for BMC LAN channel configuration.

DHCP: IP address, Subnet Mask and Gateway Address are automatically assigned by the network's DHCP server.



When [DHCP] or [Static] is selected, do NOT modify the BMC network settings on the IPMI web page.



The default login information for the IPMI web interface is:

Username: admin

Password: admin

ASRock Rack American Megatrends

Username: admin

Password: *****

[Forgot Password?](#)

Login

Language: English

For more instructions on how to set up remote control environment and use the IPMI management platform, please refer to the IPMI Configuration User Guide or go to the Support website at: <http://www.asrockrack.com/support/ipmi.asp>

BMC Mac Backup Tool

Use this to restore BMC Mac from the backup.

3.6 Security Screen

In this section, you may set or change the supervisor/user password for the system. For the user password, you may also clear it.



Supervisor Password

Set or change the password for the administrator account. Only the administrator has authority to change the settings in the UEFI Setup Utility. Leave it blank and press enter to remove the password.

User Password

Set or change the password for the user account. Users are unable to change the settings in the UEFI Setup Utility. Leave it blank and press enter to remove the password.

3.7 Boot Screen

In this section, it will display the available devices on your system for you to configure the boot settings and the boot priority.



Boot Option #1

Use this item to set the system boot order.

Boot Option #2

Use this item to set the system boot order.

Boot Option #3

Use this item to set the system boot order.

USB Device BBS Priorities

Use this item to set the system boot order from USB devices.

Boot From Onboard LAN

Use this item to enable or disable the Boot From Onboard LAN feature.

Setup Prompt Timeout

This shows the number of seconds to wait for setup activation key. 65535(0xFFFF) means indefinite waiting.

Bootup Num-Lock

If this item is set to [On], it will automatically activate the Numeric Lock function after boot-up.

Boot Beep

Select whether the Boot Beep should be turned on or off when the system boots up. Please note that a buzzer is needed.

Full Screen Logo

Use this item to enable or disable OEM Logo. The default value is [Enabled].

AddOn ROM Display

Use this option to adjust AddOn ROM Display. If you enable the option “Full Screen Logo” but you want to see the AddOn ROM information when the system boots, please select [Enabled]. Configuration options: [Enabled] and [Disabled]. The default value is [Enabled].

3.8 Event Logs



Change Smbios Event Log Settings

This allows you to configure the Smbios Event Log Settings.

View Smbios Event Log

This allows you to view the Smbios Event Log.

3.9 Exit Screen



Save Changes and Exit

When you select this option, the following message “Save configuration changes and exit setup?” will pop-out. Select [Yes] to save the changes and exit the UEFI SETUP UTILITY.

Discard Changes and Exit

When you select this option, the following message “Discard changes and exit setup?” will pop-out. Select [Yes] to exit the UEFI SETUP UTILITY without saving any changes.

Discard Changes

When you select this option, the following message “Discard changes?” will pop-out. Select [Yes] to discard all changes.

Load UEFI Defaults

Load UEFI default values for all the setup questions. F9 key can be used for this operation.

Chapter 4 Software Support

4.1 Install Operating System

This motherboard supports Microsoft® Windows® Server 2008 R2 SP1 (64 bit) / 2012 (64 bit) / Linux compliant. Because motherboard settings and hardware options vary, use the setup procedures in this chapter for general reference only. Refer your OS documentation for more information.

4.2 Support CD Information

The Support CD that came with the motherboard contains necessary drivers and useful utilities that enhance the motherboard's features.

4.2.1 Running The Support CD

To begin using the support CD, insert the CD into your CD-ROM drive. The CD automatically displays the Main Menu if "AUTORUN" is enabled in your computer. If the Main Menu does not appear automatically, locate and double click on the file "ASRSetup.exe" from the root folder in the Support CD to display the menu.

4.2.2 Drivers Menu

The Drivers Menu shows the available device's drivers if the system detects installed devices. Please install the necessary drivers to activate the devices.

4.2.3 Utilities Menu

The Utilities Menu shows the application softwares that the motherboard supports. Click on a specific item then follow the installation wizard to install it.

4.2.4 Contact Information

If you need to contact ASRock Rack or want to know more about ASRock Rack, welcome to visit ASRock Rack's website at <http://www.ASRockRack.com>; or you may contact your dealer for further information.

Chapter 5 Troubleshooting

5.1 Troubleshooting Procedures

Follow the procedures below to troubleshoot your system.



Always unplug the power cord before adding, removing or changing any hardware components. Failure to do so may cause physical injuries to you and damages to motherboard components.

1. Disconnect the power cable and check whether the PWR LED is off.
2. Unplug all cables, connectors and remove all add-on cards from the motherboard.
Make sure that the jumpers are set to default settings.
3. Confirm that there are no short circuits between the motherboard and the chassis.
4. Install a CPU and fan on the motherboard, then connect the chassis speaker and power LED.

If there is no power...

1. Confirm that there are no short circuits between the motherboard and the chassis.
2. Make sure that the jumpers are set to default settings.
3. Check the settings of the 115V/230V switch on the power supply.
4. Verify if the battery on the motherboard provides ~3VDC. Install a new battery if it does not.

If there is no video...

1. Try replugging the monitor cables and power cord.
2. Check for memory errors.

If there are memory errors...

1. Verify that the DIMM modules are properly seated in the slots.
2. Use recommended DDR3 1600/1333/1066 non ECC, unbuffered DIMMs.
3. If you have installed more than one DIMM modules, they should be identical with the same brand, speed, size and chip-type.
4. Try inserting different DIMM modules into different slots to identify faulty ones.
5. Check the settings of the 115V/230V switch on the power supply.

Unable to save system setup configurations...

1. Verify if the battery on the motherboard provides ~3VDC. Install a new battery if it does not.
2. Confirm whether your power supply provides adequate and stable power.

Other problems...

1. Try searching keywords related to your problem on ASRock Rack's FAQ page:
<http://www.asrockrack.com/support>

5.2 Technical Support Procedures

If you have tried the troubleshooting procedures mentioned above and the problems are still unsolved, please contact ASRock Rack's technical support with the following information:

1. Your contact information
2. Model name, BIOS version and problem type
3. System configuration
4. Problem description

You may contact ASRock Rack's technical support at:

<http://www.asrockrack.com/support/tsd.asp>

5.3 Returning Merchandise for Service

For warranty service, the receipt or a copy of your invoice marked with the date of purchase is required. By calling your vendor or going to our RMA website (<http://event.asrockrack.com/tsd.asp>) you may obtain a Returned Merchandise Authorization (RMA) number.

The RMA number should be displayed on the outside of the shipping carton which is mailed prepaid or hand-carried when you return the motherboard to the manufacturer. Shipping and handling charges will be applied for all orders that must be mailed when service is complete.

This warranty does not cover damages incurred in shipping or from failure due to alteration, misuse, abuse or improper maintenance of products.

Contact your distributor first for any product related problems during the warranty period.

Chapter 6: Net Framework Installation Guide

To let Intel® RSTe works properly, it is required to install Net Framework. Please follow the steps below to enable “.Net Framework” feature on Microsoft® Windows® Server 2008 R2.

6.1 Installing .Net Framework 3.5.1 (For Server 2008 R2)

1. Double-click the Server Manager icon in the Windows system tray.



2. Click Add Features in the right hand pane.



3. Check the box next to .Net Framework 3.5.1 and then click **Next**.

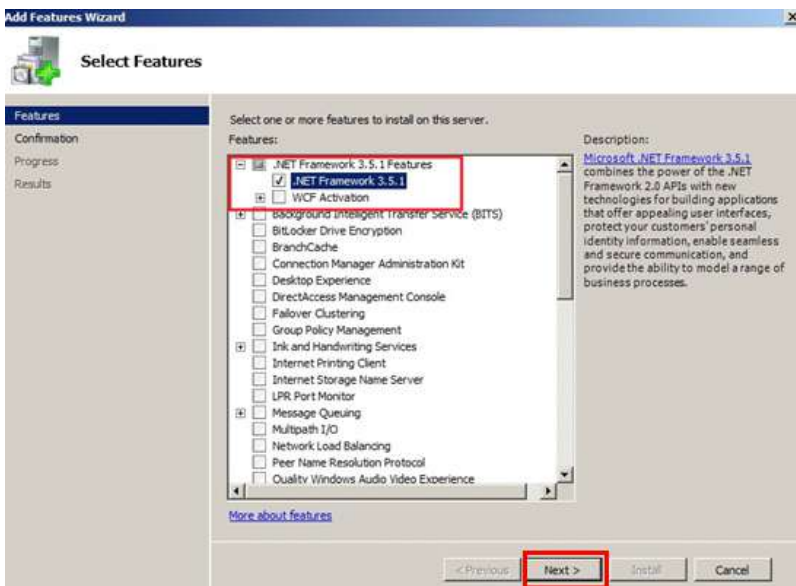

4. Click **Next** to continue.

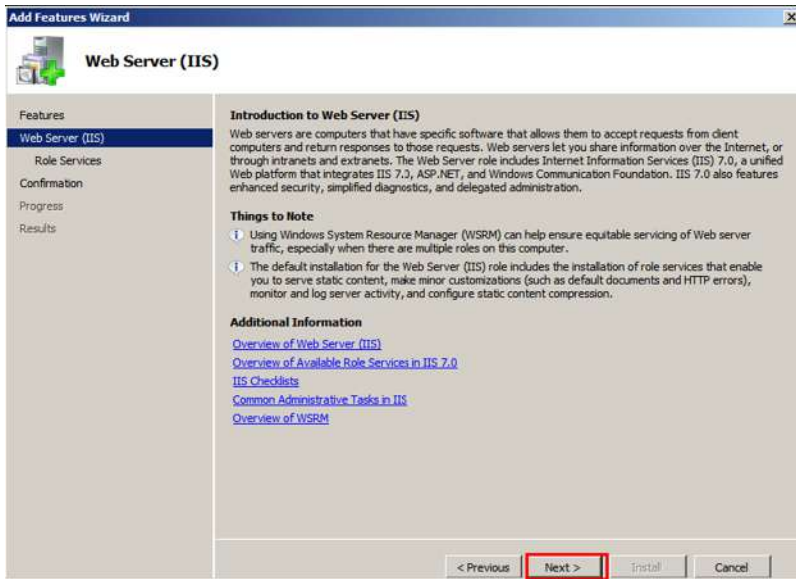

5. Click **Install** to start installing .Net Framework 3.5.1.

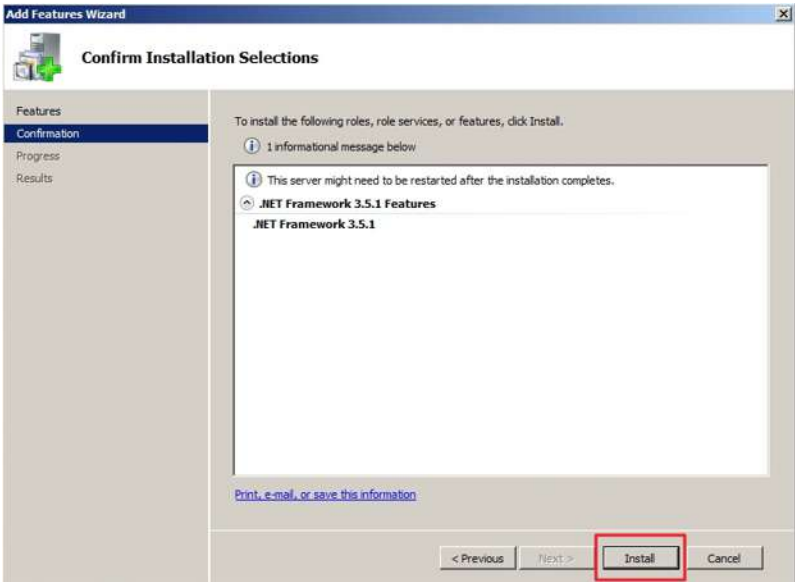

6. After the installation completes, click **Close**.

