



OPEN Industry Standard, Flexible Architecture

GREEN Less Heat, Less Power Consumption

STABLE Robust Design, Quality Parts

Stable and
Reliable Solution

Server/Workstation

Motherboard

C422 WSI/IPMI

X299 WSI/IPMI

User Manual

English



Version 1.0

Published August 2018

Copyright©2018 ASRock Rack Inc. All rights reserved.

Copyright Notice:

No part of this documentation may be reproduced, transcribed, transmitted, or translated in any language, in any form or by any means, except duplication of documentation by the purchaser for backup purpose, without written consent of ASRock Rack Inc.

Products and corporate names appearing in this documentation may or may not be registered trademarks or copyrights of their respective companies, and are used only for identification or explanation and to the owners' benefit, without intent to infringe.

Disclaimer:

Specifications and information contained in this documentation are furnished for informational use only and subject to change without notice, and should not be constructed as a commitment by ASRock Rack. ASRock Rack assumes no responsibility for any errors or omissions that may appear in this documentation.

With respect to the contents of this documentation, ASRock Rack does not provide warranty of any kind, either expressed or implied, including but not limited to the implied warranties or conditions of merchantability or fitness for a particular purpose.

In no event shall ASRock Rack, its directors, officers, employees, or agents be liable for any indirect, special, incidental, or consequential damages (including damages for loss of profits, loss of business, loss of data, interruption of business and the like), even if ASRock Rack has been advised of the possibility of such damages arising from any defect or error in the documentation or product.



This device complies with Part 15 of the FCC Rules. Operation is subject to the following two conditions:

- (1) this device may not cause harmful interference, and
- (2) this device must accept any interference received, including interference that may cause undesired operation.

CALIFORNIA, USA ONLY

The Lithium battery adopted on this motherboard contains Perchlorate, a toxic substance controlled in Perchlorate Best Management Practices (BMP) regulations passed by the California Legislature. When you discard the Lithium battery in California, USA, please follow the related regulations in advance.

“Perchlorate Material-special handling may apply, see www.dtsc.ca.gov/hazardouswaste/perchlorate”

ASRock Rack's Website: www.ASRockRack.com

Contact Information

If you need to contact ASRock Rack or want to know more about ASRock Rack, you're welcome to visit ASRock Rack's website at www.ASRockRack.com; or you may contact your dealer for further information.

ASRock Rack Incorporation

6F., No.37, Sec. 2, Jhongyang S. Rd., Beitou District,

Taipei City 112, Taiwan (R.O.C.)

Contents

Chapter 1 Introduction	1
1.1 Package Contents	1
1.2 Specifications	2
1.3 Unique Features	5
1.4 Motherboard Layout	6
1.5 Onboard LED Indicators	9
1.6 I/O Panel	10
1.7 Block Diagram	12
Chapter 2 Installation	13
2.1 Screw Holes	13
2.2 Pre-installation Precautions	13
2.3 Installation of Memory Modules (SODIMM)	18
2.4 Expansion Slot (PCI Express Slot)	20
2.5 Jumper Setup	21
2.6 Onboard Headers and Connectors	22
2.7 Driver Installation Guide	27
2.8 Dual LAN and Teaming Operation Guide	28
2.9 M.2_SSD (NGFF) Module Installation Guide (M2_2)	29
Chapter 3 UEFI Setup Utility	30
3.1 Introduction	30
3.1.1 UEFI Menu Bar	30
3.1.2 Navigation Keys	31
3.2 Main Screen	32

3.3	OC Tweaker Screen (for X299 WSI/IPMI only)	33
3.4	Advanced Screen	50
3.4.1	CPU Configuration	51
3.4.2	I/O Configuration	53
3.4.3	Chipset Configuration	54
3.4.4	Storage Configuration	56
3.4.5	Super IO Configuration	57
3.4.6	Serial Port Console Redirection	58
3.4.7	H/W Monitor	61
3.4.8	Intel ME Information	63
3.4.9	ACPI Configuration	64
3.4.10	USB Configuration	65
3.4.11	Instant Flash	66
3.5	Security	67
3.6	Boot Screen	68
3.7	Server Mgmt	72
3.7.1	System Event Log	73
3.7.2	BMC Network Configuration	74
3.8	Event Logs	75
3.9	Exit Screen	77
Chapter 4 Software Support		78
4.1	Install Operating System	78
4.2	Support CD Information	78
4.2.1	Running The Support CD	78

4.2.2	Drivers Menu	78
4.2.3	Utilities Menu	78
4.2.4	Contact Information	78
Chapter 5 Troubleshooting		79
5.1	Troubleshooting Procedures	79
5.2	Technical Support Procedures	81
5.3	Returning Merchandise for Service	81

Chapter 1 Introduction

Thank you for purchasing ASRock Rack **C422 WSI/IPMI / X299 WSI/IPMI** motherboard, a reliable motherboard produced under ASRock Rack's consistently stringent quality control. It delivers excellent performance with robust design conforming to ASRock Rack's commitment to quality and endurance.

In this manual, chapter 1 and 2 contains introduction of the motherboard and step-by-step guide to the hardware installation. Chapter 3 and 4 contains the configuration guide to BIOS setup and information of the Support CD.



Because the motherboard specifications and the BIOS software might be updated, the content of this manual will be subject to change without notice. In case any modifications of this manual occur, the updated version will be available on ASRock Rack website without further notice. You may find the latest memory and CPU support lists on ASRock Rack website as well. ASRock Rack's Website: www.ASRockRack.com

*If you require technical support related to this motherboard, please visit our website for specific information about the model you are using.
<http://www.asrockrack.com/support/>*

1.1 Package Contents

- ASRock Rack C422 WSI/IPMI / X299 WSI/IPMI Motherboard
(Mini ITX Form Factor: 6.7-in x 6.7-in, 17.02 cm x17.02 cm)
- Support CD
- Quick Installation Guide
- 1 x SATA3 Cable (60cm)
- 1 x I/O Shield
- 1 x Screw for M.2 Socket



If any items are missing or appear damaged, contact your authorized dealer.

1.2 Specifications

C422 WSI/IPMI/ X299 WSI/IPMI	
MB Physical Status	
Form Factor	Mini ITX
Dimension	6.7" x 6.7" (17.02cm x17.02 cm)
Processor System	
CPU	C422 WSI/IPMI: Supports Intel® Skylake-W Processors (LGA-2066) X299 WSI/IPMI: Supports Intel® Skylake-X Processors (LGA-2066) <i>(only support s i9)</i>
Socket	Single Socket R4(LGA 2066)
Chipset	C422 WSI/IPMI: Intel® C422 X299 WSI/IPMI: Intel® X299
System Memory	
Capacity	- 4 x DDR4 DIMM slots - Supports up to 64GB ECC SO-DIMM
DIMM Sizes and Type per DIMM	Quad Channel DDR4 memory technology C422 WSI/IPMI: SO-RDIMM: 8GB, 4GB ECC SO-DIMM: 8GB, 4GB Non-ECC SO-UDIMM: 16GB, 8GB, 4GB X299 WSI/IPMI: SO-DIMM: 16GB, 8GB ECC SO-DIMM: 32GB*,16GB, 8GB, 4GB <i>*32GB is supported by Cascadelake-X CPU only.</i>
Frequency	C422 WSI/IPMI: SO-RDIMM: 2666/2400/2133/1866/1600MHz ECC SO-DIMM: 2666/2400/2133/1866/1600MHz Non-ECC SO-UDIMM: 2666/2400/2133/1866/1600MHz X299 WSI/IPMI: SO-DIMM: 2666/2400/2133MHz * ECC SO-DIMM: 2666/2400/2133MHz** <i>*Please check our QVL before installation. **It can be installed but no ECC function is supported.</i>
Voltage	1.2 V
Expansion Slot	
PCIe 3.0 x16	1 slot (from CPU)

Storage	
SATA Controller	C422 WSI/IPMI: C422: 4x SATA3 6Gb/s X299 WSI/IPMI: X299: 4x SATA3 6Gb/s
OCuLink for U.2	1(from PCH)
Ethernet	
Interface	1000 /100 /10 Mbps
LAN	- 2 x RJ45 GLAN by Intel® i350 - Supports Wake-On-LAN - Supports Energy Efficient Ethernet 802.3az - Supports Dual LAN with Teaming function - Supports PXE
Management	
BMC Controller	ASPEED AST2500 : IPMI (Intelligent Platform Management Interface) 2.0 with Ikmv and vMedia support
IPMI Dedicated LAN	1 x Realtek RTL8211E for dedicated management GLAN
Features	- Watch Dog - NMI
Graphics	
Controller	ASPEED AST2500
VRAM	DDR4 4GB
Rear Panel I/O	
VGA Port	1 x D-Sub
USB 3.0 Port	2
LAN Port	- RJ45:2+1(IPMI) - LAN Ports with LED (ACT/LINK LED and SPEED LED)
Internal Connector	
Auxiliary Panel Header	1 (include chassis intrusion, location button & LED, and front LAN LED)
COM Header	1 (from SIO)
Speaker	1(4 pin)
TPM Header	1
IPMB Header	1
SGPIO Header	1
Fan Header	3 Fans (1CPU/2 system)
ATX Power	1x (24-pin) + 1x (8-pin))
USB 3.0 Header	1 (support 2 USB3.0)
ClearCMOS	1
NMI Button	1
Front Panel	1(rst, pwrbtn, hddled, pwrled)

M.2	1 (Bottom side, only supports 2280, PCIE(x4)/SATA3 6.0 Gb/s)
System BIOS	
BIOS Type	256Mb AMI UEFI Legal BIOS
BIOS Features	<ul style="list-style-type: none"> - Plug and Play (PnP) - ACPI 2.0 Compliance Wake Up Events - SMBIOS 2.8.0 Support - ASRock Rack Instant Flash
Hardware Monitor	
Temperature	<ul style="list-style-type: none"> - CPU Temperature Sensing - System Temperature Sensing - Card side Temperature Sensing
Fan	<ul style="list-style-type: none"> - CPU/Rear/Front Fan Tachometer - CPU Quiet Fan (Allow Chassis Fan Speed Auto-Adjust by CPU Temperature) - CPU/Rear/Front Fan Multi-Speed Control
Voltage	Voltage Monitoring: Vcore, VCCSA, VCCIO, VCCMAB, VCCMCD, 3v, 5v, 12v, 1.05V_PCH, +BAT, 3VSB, 5VSB, 5V_Dual
Support OS	
OS	<p>X299 WSI/IPMI:</p> <p>Microsoft® Windows®</p> <ul style="list-style-type: none"> - Windows 10 (64 bit) <p>C422 WSI/IPMI:</p> <p>Microsoft® Windows®</p> <ul style="list-style-type: none"> - Windows 10 (64 bit) <p>Linux®</p> <ul style="list-style-type: none"> - RedHat Enterprise Linux Server 6.9 (64 bit) / 7.3 (64 bit) / 7.5 (64 bit) - SUSE Enterprise Linux Server 11 SP4 (64 bit) / 12 SP2 (64 bit) / 12 SP3 (64 bit) - Ubuntu 16.04 (64 bit) / 16.10 (64 bit) <p>Virtual</p> <ul style="list-style-type: none"> - VMWare® Workstation 12 - Citrix XenServer 7.5 - Win hyper-V Server 2016 <p><i>* Please refer to our website for the latest OS support list.</i></p> <p><i>* On Ubuntu 16.04 (64bit) system, Intel Raid mode only supports UEFI BOOT.</i></p>

Environment

Temperature

Operation temperature: 10°C ~ 35°C / Non operation temperature: -40°C ~ 70°C

NOTE: Please refer to our website for the latest specifications.



This motherboard supports Wake from on Board LAN. To use this function, please make sure that the "Wake on Magic Packet from power off state" is enabled in Device Manager > Intel® Ethernet Connection > Power Management. And the "PCI Devices Power On" is enabled in UEFI SETUP UTILITY > Advanced > ACPI Configuration. After that, onboard LAN1&2 can wake up S5 under OS.



If you install Intel® LAN utility or Marvell SATA utility, this motherboard may fail Windows® Hardware Quality Lab (WHQL) certification tests. If you install the drivers only, it will pass the WHQL tests.

1.3 Unique Features

ASRock Rack Instant Flash is a BIOS flash utility embedded in Flash ROM. This convenient BIOS update tool allows you to update system BIOS without entering operating systems first like MS-DOS or Windows[®]. With this utility, you can press the <F6> key during the POST or the <F2> key to enter into the BIOS setup menu to access ASRock Rack Instant Flash. Just launch this tool and save the new BIOS file to your USB flash drive, floppy disk or hard drive, then you can update your BIOS only in a few clicks without preparing an additional floppy diskette or other complicated flash utility. Please be noted that the USB flash drive or hard drive must use FAT32/16/12 file system.

1.4 Motherboard Layout

Front View

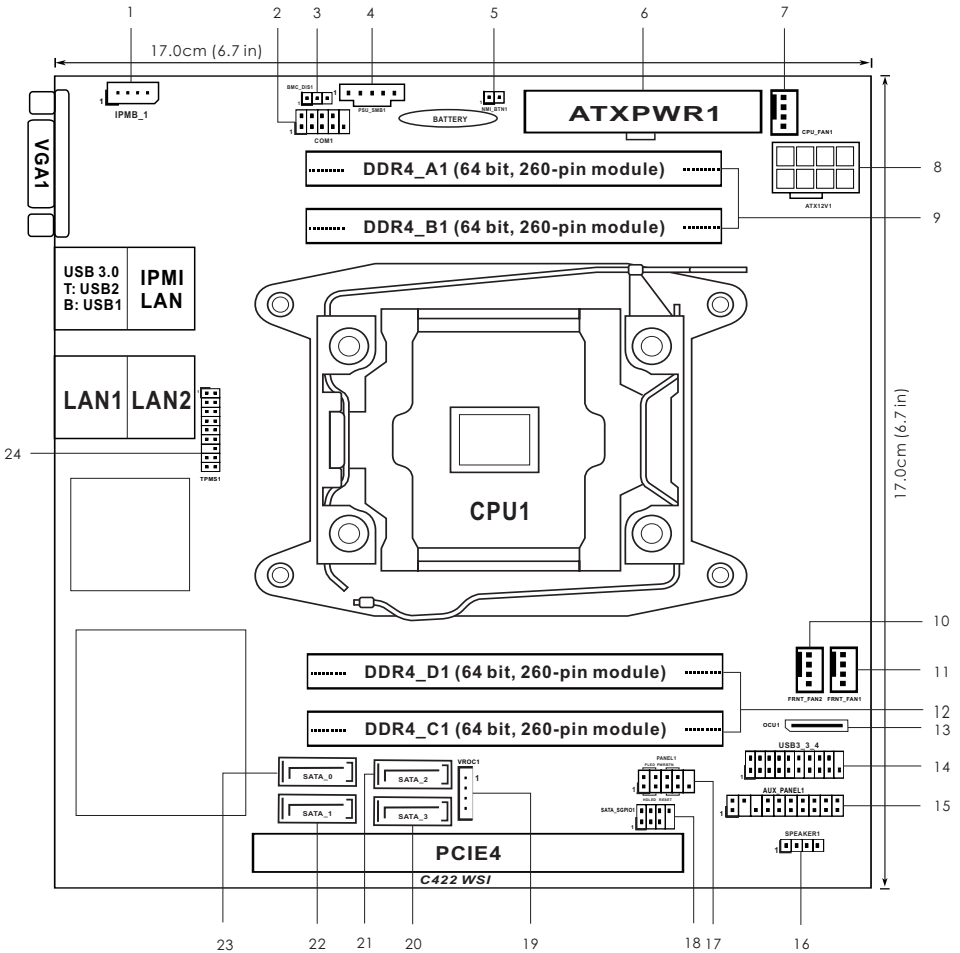

Rear View

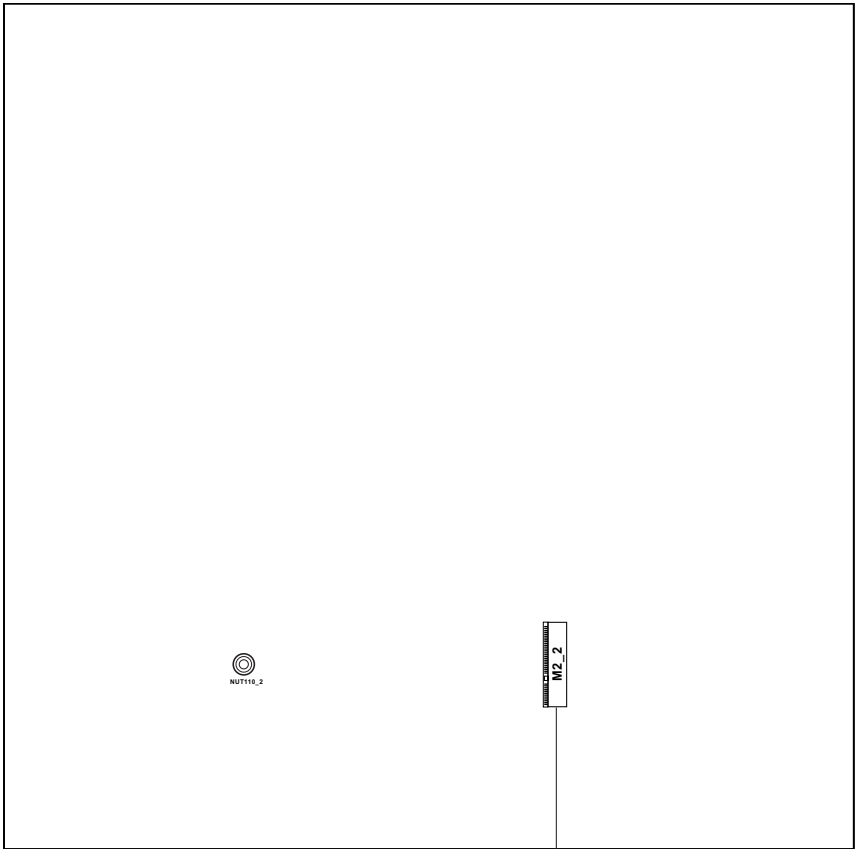

M2_2

25

No.	Description
1	Intelligent Platform Management Bus header (IPMB1_1)
2	COM Port Header (COM1)
3	Enable/Disable BMC Jumper (BMC_DIS1)
4	PSU SMBus Header (PSU_SMB1)
5	Non Maskable Interrupt Button (NMI_BTN1)
6	ATX Power Connector (ATXPWR1)
7	CPU Fan Connector (CPU_FAN1)
8	ATX 12V Power Connector (ATX12V1)
9	2 x 260-pin DDR4 SO-DIMM Slots (DDR4_A1, DDR4_B1)
10	Front Fan Connector (FRNT_FAN2)
11	Front Fan Connector (FRNT_FAN1)
12	2 x 260-pin DDR4 SO-DIMM Slots (DDR4_C1, DDR4_D1)
13	OCuLink x4 Connector (OCU1)
14	USB 3.0 Header (USB3_3_4)
15	Auxiliary Panel Header (AUX_PANEL1)
16	Chassis Speaker Header (SPEAKER1)
17	System Panel Header (PANEL1)
18	SATA SGPIO Connector (SATA_SGPIO1)
19	Virtual RAID On CPU Header (VROC1)
20	SATA3 Connector (SATA_3)
21	SATA3 Connector (SATA_2)
22	SATA3 Connector (SATA_1)
23	SATA3 Connector (SATA_0)
24	TPM Header (TPMS1)
25	M.2 Socket (M2_2) (Type 2280)

1.5 Onboard LED Indicators

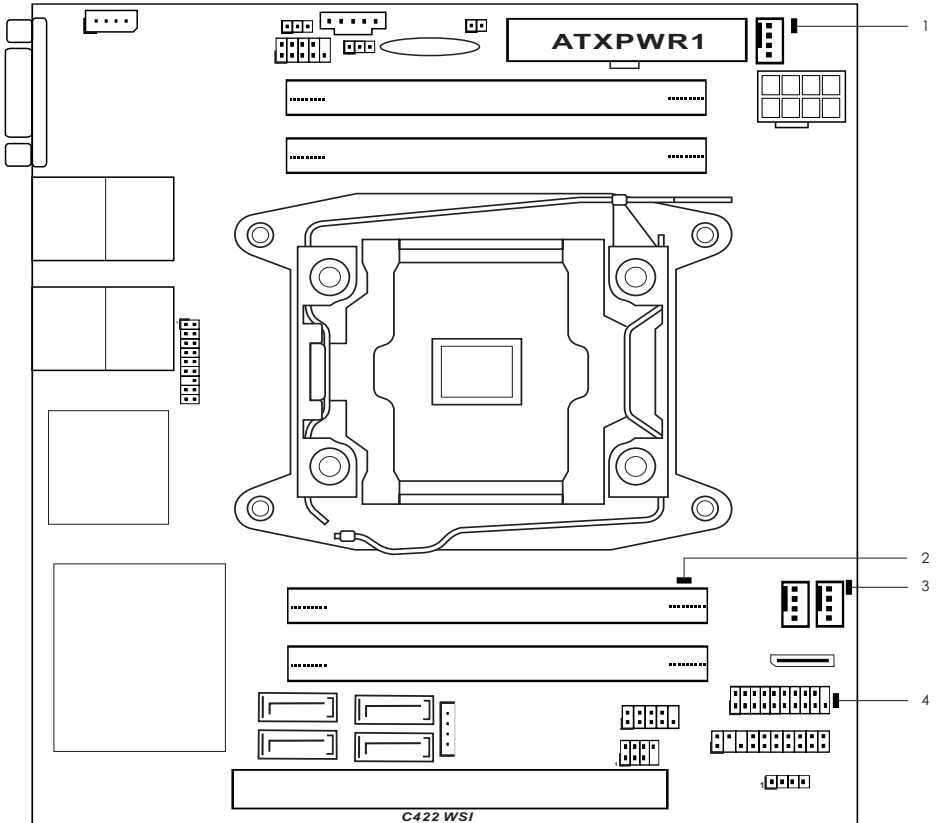

No.	Item	Status	Description
1	CPU_FAN_LED1	Amber	CPU_FAN1 failed
2	FFAN_LED2	Amber	FRNT_FAN2 failed
3	FFAN_LED1	Amber	FRNT_FAN1 failed
4	SB_PWR1	Green	STB PWR ready

1.6 I/O Panel

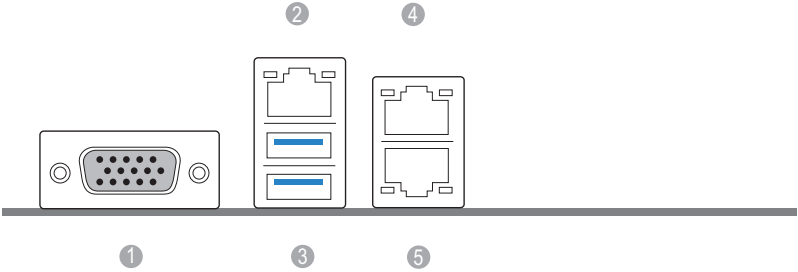

No.	Description	No.	Description
1	VGA Port (VGA1)	4	LAN RJ-45 Port (LAN1)**
2	LAN RJ-45 Port (IPMI_LAN)*	5	LAN RJ-45 Port (LAN2)**
3	USB 3.0 Ports (USB3_1_2)		

LAN Port LED Indications

*There are two LED next to the LAN port. Please refer to the table below for the LAN port LED indications.

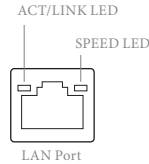

Dedicated IPMI LAN Port LED Indications

Activity / Link LED		Speed LED	
Status	Description	Status	Description
Off	No Link	Off	10M bps connection or no link
Blinking Yellow	Data Activity	Yellow	100M bps connection
On	Link	Green	1G bps connection

**There are two LEDs on each LAN port. Please refer to the table below for the LAN port LED indications.

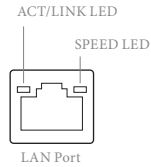

LAN Port LED Indications

Activity / Link LED		Speed LED	
Status	Description	Status	Description
Off	No Link	Off	10M bps connection or no link
Blinking Yellow	Data Activity	Yellow	100M bps connection
On	Link	Green	1Gbps connection

1.7 Block Diagram

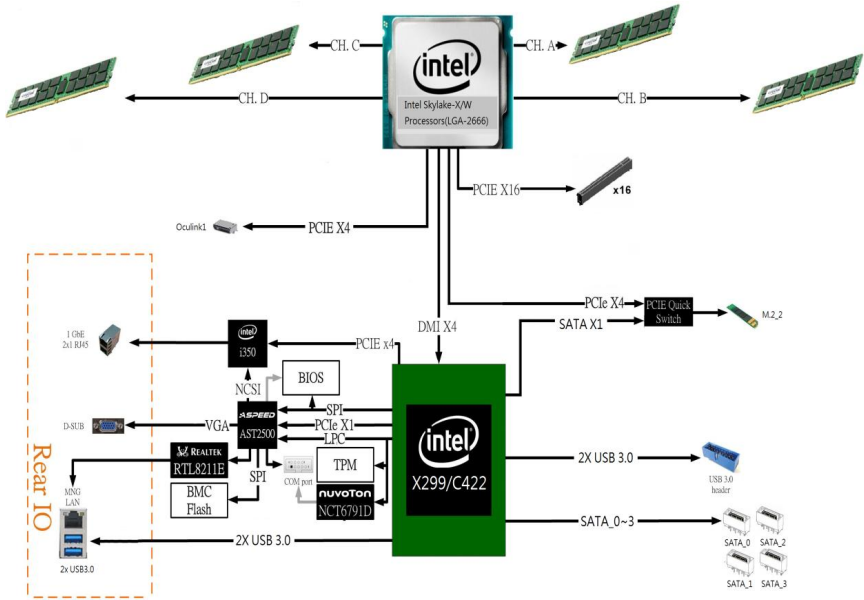

Chapter 2 Installation

This is a mini ITX form factor (6.7" x 6.7", 17.02 cm x 17.02 cm) motherboard. Before you install the motherboard, study the configuration of your chassis to ensure that the motherboard fits into it.



Make sure to unplug the power cord before installing or removing the motherboard. Failure to do so may cause physical injuries to you and damages to motherboard components.

2.1 Screw Holes

Place screws into the holes indicated by circles to secure the motherboard to the chassis.



Do not over-tighten the screws! Doing so may damage the motherboard.

2.2 Pre-installation Precautions

Take note of the following precautions before you install motherboard components or change any motherboard settings.

1. Unplug the power cord from the wall socket before touching any components.
2. To avoid damaging the motherboard's components due to static electricity, NEVER place your motherboard directly on the carpet or the like. Also remember to use a grounded wrist strap or touch a safety grounded object before you handle the components.
3. Hold components by the edges and do not touch the ICs.
4. Whenever you uninstall any component, place it on a grounded anti-static pad or in the bag that comes with the component.
5. When placing screws into the screw holes to secure the motherboard to the chassis, please do not over-tighten the screws! Doing so may damage the motherboard.



Before you install or remove any component, ensure that the power is switched off or the power cord is detached from the power supply. Failure to do so may cause severe damage to the motherboard, peripherals, and/or components.

2.3 Installing the CPU



1. Before you insert the **2066-Pin CPU** into the socket, please check if the **PnP cap** is on the socket, if the CPU surface is unclean, or if there are any **bent pins** in the socket. Do not force to insert the CPU into the socket if above situation is found. Otherwise, the CPU will be seriously damaged.
2. Unplug all power cables before installing the CPU.

1

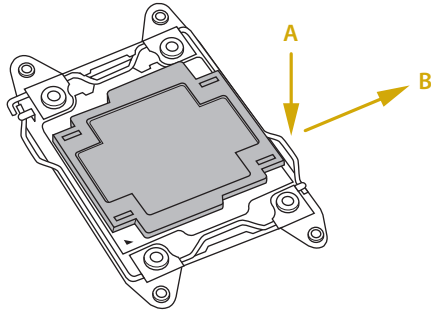

2

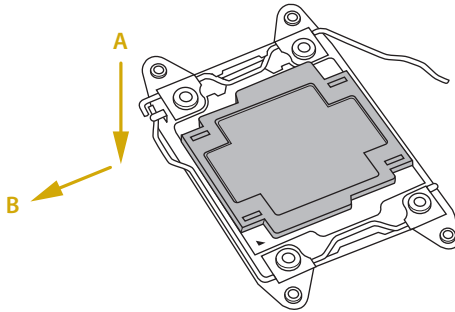

3

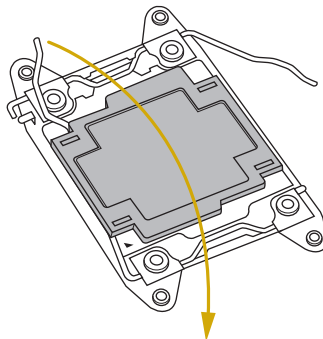

4

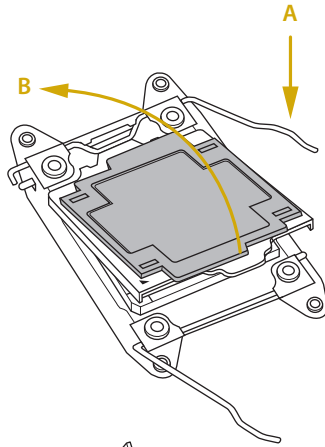

5

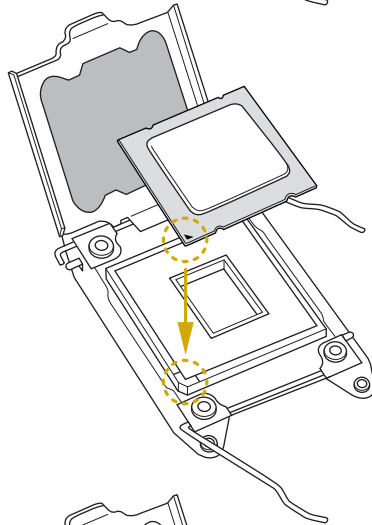

6

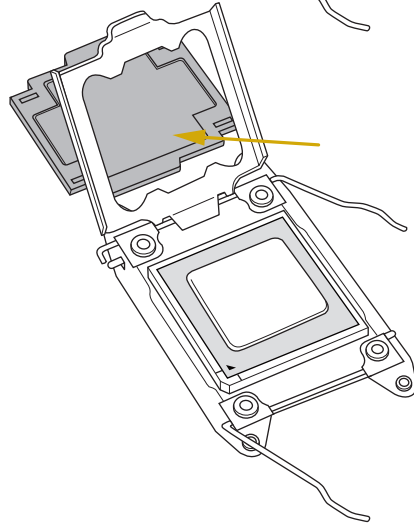

7

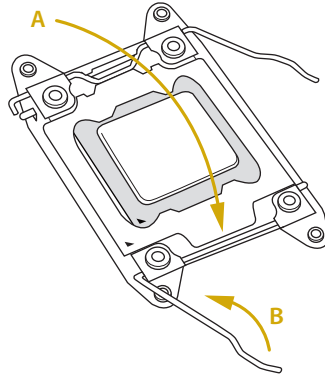

8

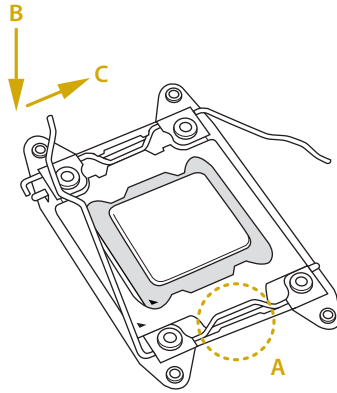

9

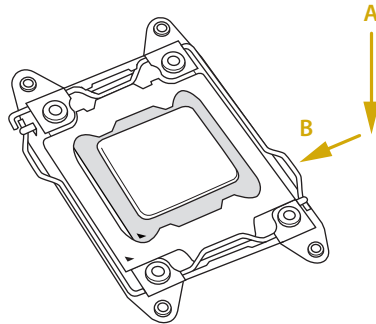

Please save and replace the cover if the processor is removed. The cover must be placed if you wish to return the motherboard for after service.

2.2 Installing the CPU Fan and Heatsink

10

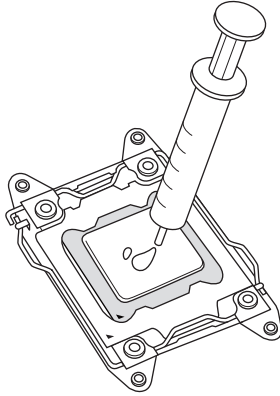

11

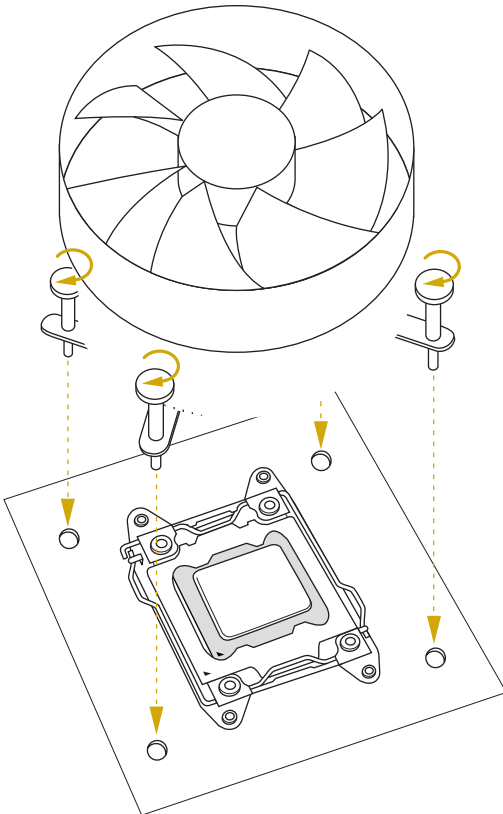

12

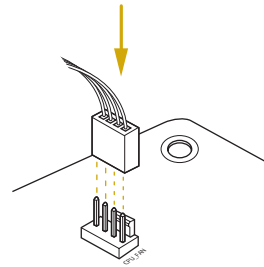

2.3 Installation of Memory Modules (SODIMM)

This motherboard provides four 260-pin DDR4 (Double Data Rate 4) SO-DIMM slots, and supports Quad Channel Memory Technology.



1. For quad channel configuration, you always need to install identical (the same brand, speed, size and chip-type) DDR4 DIMM pairs.
2. It is not allowed to install a DDR, DDR2 or DDR3 memory module into a DDR4 slot; otherwise, this motherboard and DIMM may be damaged.
3. The DIMM only fits in one correct orientation. It will cause permanent damage to the motherboard and the DIMM if you force the DIMM into the slot at incorrect orientation.

Dual Channel Memory Configuration

Priority	DDR4_A1	DDR4_B1	DDR4_C1	DDR4_D1
1		Populated		Populated
2	Populated		Populated	

Quad Channel Memory Configuration

Priority	DDR4_A1	DDR4_B1	DDR4_C1	DDR4_D1
1	Populated	Populated	Populated	Populated

- If only two memory modules are installed in the DDR4 DIMM slots, then Dual Channel Memory Technology is activated. If three memory modules are installed, then Triple Channel Memory Technology is activated. If four memory modules are installed in the DDR4 DIMM slots, then Quad Channel Memory Technology is activated.

1

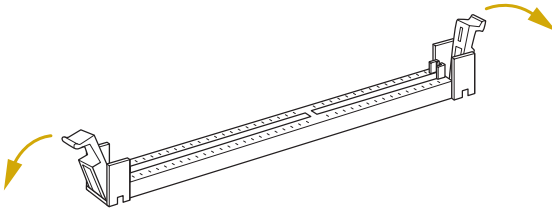

2

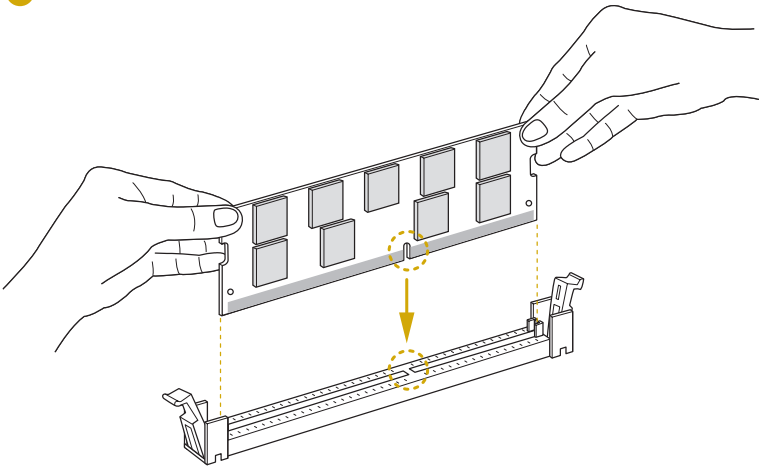

3

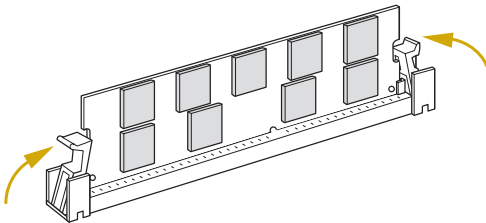

2.4 Expansion Slot (PCI Express Slot)

There is a PCI Express slot on this motherboard.

PCIe slot:

PCIe4 (PCIe 3.0 x16 slot) is used for PCI Express x16 lane width cards.

Slot	Generation	Mechanical	Electrical	Source
PCIe4	3.0	x16	x16	CPU

Installing an expansion card

- Step 1. Before installing an expansion card, please make sure that the power supply is switched off or the power cord is unplugged. Please read the documentation of the expansion card and make necessary hardware settings for the card before you start the installation.
- Step 2. Remove the system unit cover (if your motherboard is already installed in a chassis).
- Step 3. Remove the bracket facing the slot that you intend to use. Keep the screws for later use.
- Step 4. Align the card connector with the slot and press firmly until the card is completely seated on the slot.
- Step 5. Fasten the card to the chassis with screws.
- Step 6. Replace the system cover.

2.5 Jumper Setup

The illustration shows how jumpers are setup. When the jumper cap is placed on the pins, the jumper is “Short”. If no jumper cap is placed on the pins, the jumper is “Open”. The illustration shows a 3-pin jumper whose pin1 and pin2 are “Short” when a jumper cap is placed on these 2 pins.

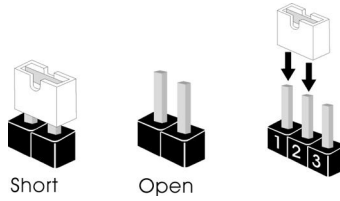

Enable/Disable BMC Jumper
(3-pin BMC_DIS1)
(see p.6, No. 3)



Normal Mode (Default)
BMC Enabled



BMC Disabled

2.6 Onboard Headers and Connectors



Onboard headers and connectors are NOT jumpers. Do NOT place jumper caps over these headers and connectors. Placing jumper caps over the headers and connectors will cause permanent damage to the motherboard.

System Panel Header
(9-pin PANEL1)
(see p.6, No. 17)

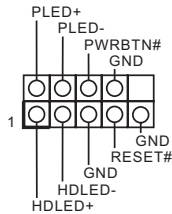

Connect the power switch, reset switch and system status indicator on the chassis to this header according to the pin assignments. Particularly note the positive and negative note the positive and negative pins before connecting the cables.



PWRBTN (Power Switch):

Connect to the power switch on the chassis front panel. You may configure the way to turn off your system using the power switch.

RESET (Reset Switch):

Connect to the reset switch on the chassis front panel. Press the reset switch to restart the computer if the computer freezes and fails to perform a normal restart.

PLED (System Power LED):

Connect to the power status indicator on the chassis front panel. The LED is on when the system is operating. The LED is off when the system is in S4 sleep state or powered off (S5).

HDLED (Hard Drive Activity LED):

Connect to the hard drive activity LED on the chassis front panel. The LED is on when the hard drive is reading or writing data.

The front panel design may differ by chassis. A front panel module mainly consists of power switch, reset switch, power LED, hard drive activity LED, speaker and etc. When connecting your chassis front panel module to this header, make sure the wire assignments and the pin assignments are matched correctly.

Auxiliary Panel Header
(18-pin AUX PANEL_1)
(see p.6, No. 15)

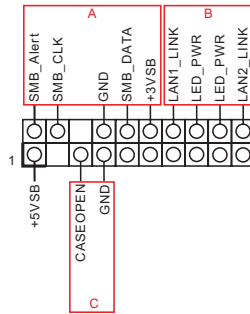

This header supports multiple functions on the front panel, including the front panel SMB, internet status indicator and chassis intrusion pin.



A. Front panel SMBus connecting pin (6-1 pin FPSMB)

This header allows you to connect SMBus (System Management Bus) equipment. It can be used for communication between peripheral equipment in the system, which has slower transmission rates, and power management equipment.

B. Internet status indicator (2-pin LAN1_LED, LAN2_LED)

These two 2-pin headers allow you to use the Gigabit internet indicator cable to connect to the LAN status indicator. When this indicator flickers, it means that the internet is properly connected.

C. Chassis intrusion pin (2-pin CHASSIS)

This header is provided for host computer chassis with chassis intrusion detection designs. In addition, it must also work with external detection equipment, such as a chassis intrusion detection sensor or a microswitch. When this function is activated, if any chassis component movement occurs, the sensor will immediately detect it and send a signal to this header, and the system will then record this chassis intrusion event. The default setting is set to the CASEOPEN and GND pin; this function is off.

Serial ATA3 Connectors

- (SATA_0)
(see p.6, No. 23)
- (SATA_1)
(see p.6, No. 22)
- (SATA_2)
(see p.6, No. 21)
- (SATA_3)
(see p.6, No. 20)

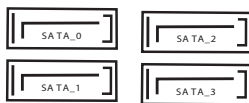

These SATA3 connectors support SATA data cables for internal storage devices with up to 6.0 Gb/s data transfer rate.

USB 3.0 Header (19-pin USB3_3_4) (see p.6, No. 14)

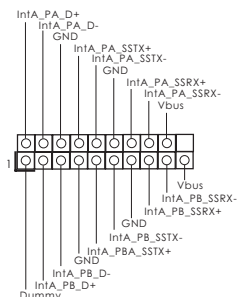

Besides two default USB 3.0 ports on the I/O panel, there is one USB 3.0 header on this motherboard. This USB 3.0 header can support two USB 3.0 ports.

CPU Fan Connector (4-pin CPU_FAN1) (see p.6, No. 7)

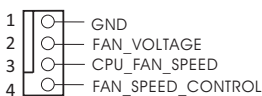

This motherboard provides one 4-Pin CPU fan (Quiet Fan) connectors. If you plan to connect a 3-Pin CPU fan, please connect it to Pin 1-3.

**For more details, please refer to the Cooler QVL list on the ASRock Rack website.*

Front Fan Connectors (4-pin FRNT_FAN1) (see p.6, No. 11) (4-pin FRNT_FAN2) (see p.6, No. 10)

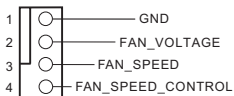

Please connect fan cables to the fan connector and match the black wire to the ground pin. All fans support Fan Control.

ATX Power Connector
(24-pin ATXPWR1)
(see p.6, No. 6)

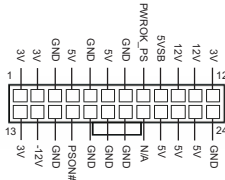

This motherboard provides a 24-pin ATX power connector. To use a 20-pin ATX power supply, please plug it along Pin 1 and Pin 13.

ATX 12V Power Connector
(4-pin ATX12V1)
(see p.6, No. 8)

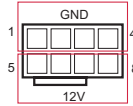

This motherboard provides one 8-pin 12V DC Input power connector.

TPM Header
(17-pin TPMS1)
(see p.6, No. 24)

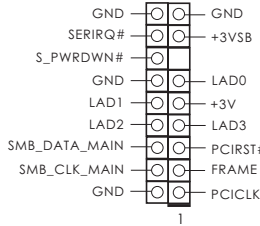

This connector supports Trusted Platform Module (TPM) system, which can securely store keys, digital certificates, passwords, and data. A TPM system also helps enhance network security, protects digital identities, and ensures platform integrity.

Non Maskable Interrupt Button Header
(2-pin NMI_BTN1)
(see p.6, No. 5)



Please connect a NMI device to this header.

Serial Port Header
(9-pin COM1)
(see p.6, No. 2)

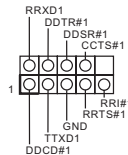

This COM header supports a serial port module.

PSU SMBus Header
(PSU_SMB1)
(see p.6, No. 4)

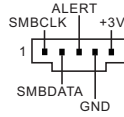

PSU SMBus monitors the status of the power supply, fan and system temperature.

Intelligent Platform Management Bus Header
(4-pin IPMB1)
(see p.6, No. 1)

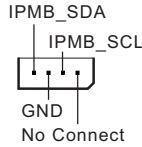

This 4-pin connector is used to provide a cabled base-board or front panel connection for value added features and 3rd-party add-in cards, such as Emergency Management cards, that provide management features using the IPMB.

OCuLink Connector
(OCU1)
(see p.6, No. 13)



Please connect a PCIE SSD to this connector.

Chassis Speaker Header
(4-pin SPEAKER1)
(see p.6, No. 16)

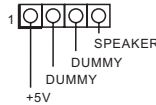

Please connect the chassis speaker to this header.

Serial General Purpose Input/Output Header
(7-pin SATA_SGPIO1)
(see p.6, No. 18)

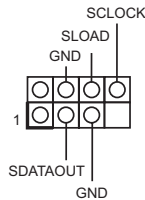

The header supports Serial Link interface for onboard SATA connections.

Virtual RAID On CPU Header
(4-pin VROC1)
(see p.6, No. 19)

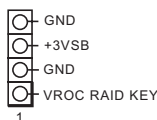

This connector supports Intel® Virtual RAID on CPU and NVME/AHCI RAID on CPU PCIE.

With the introduction of the Intel VROC product, there are three modes of operation:

SKU	HW key required	Key features
Pass-thru	Not needed	<ul style="list-style-type: none"> • Pass-thru only (no RAID) • LED Management • Hot Plug Support • RAID 0 support for Intel Fultondale NVMe SSDs
Standard	VROCSTANMOD	<ul style="list-style-type: none"> • Pass-thru SKU features • RAID 0, 1, 10
Premium	VROCPREMMOD	<ul style="list-style-type: none"> • Standard SKU features • RAID 5
ISS	VROCISSDMOD	<ul style="list-style-type: none"> • RAID 5 Write Hole Closure

*Only Intel SSDs are supported.

*For further details on VROC, please refer to the official information released by Intel.

2.7 Driver Installation Guide

To install the drivers to your system, please insert the support CD to your optical drive first. Then, the drivers compatible to your system can be auto-detected and listed on the support CD driver page. Please follow the order from top to bottom to install those required drivers. Therefore, the drivers you install can work properly.

2.8 Dual LAN and Teaming Operation Guide

Dual LAN with Teaming enabled on this motherboard allows two single connections to act as one single connection(s) for twice the transmission bandwidth, making data transmission more effective and improving the quality of transmission of distant images. Fault tolerance on the dual LAN network prevents network downtime by transferring the workload from a failed port to a working port.



The speed of transmission is subject to the actual network environment or status even with Teaming enabled.

Before setting up Teaming, please make sure whether your Switch (or Router) supports Teaming (IEEE 802.3ad Link Aggregation). You can specify a preferred adapter in Intel PROSet. Under normal conditions, the Primary adapter handles all non-TCP/IP traffic. The Secondary adapter will receive fallback traffic if the primary fails. If the Preferred Primary adapter fails, but is later restored to an active status, control is automatically switched back to the Preferred Primary adapter.

Step 1

From **Device Manager**, open the properties of a team.

Step 2

Click the **Settings** tab.

Step 3

Click the **Modify Team** button.

Step 4

Select the adapter you want to be the primary adapter and click the **Set Primary** button.

If you do not specify a preferred primary adapter, the software will choose an adapter of the highest capability (model and speed) to act as the default primary. If a failover occurs, another adapter becomes the primary. The adapter will, however, rejoin the team as a non-primary.

2.9 M.2_SSD (NGFF) Module Installation Guide (M2_2)

The M.2, also known as the Next Generation Form Factor (NGFF), is a small size and versatile card edge connector that aims to replace mPCIe and mSATA. The Socket (M2_2) supports M.2 SATA3 6.0 Gb/s module and M.2 PCI Express module up to Gen3 x4 (32 Gb/s).

Installing the M.2_SSD (NGFF) Module

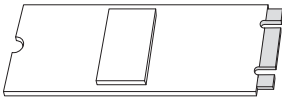

Step 1

Prepare a M.2_SSD (NGFF) module and the screw.

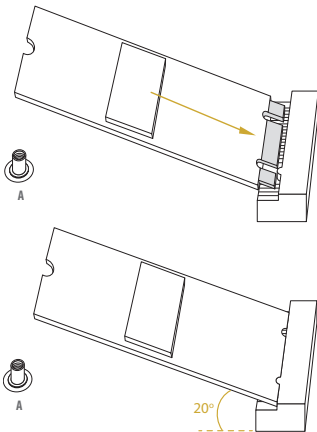

Step 2

Gently insert the M.2 (NGFF) SSD module into the M.2 slot. Please be aware that the M.2 (NGFF) SSD module only fits in one orientation.

No.	1
Nut Location	A
PCB Length	8cm
Module Type	Type 2280

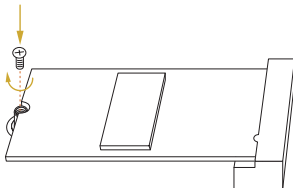

Step 3

Tighten the screw with a screwdriver to secure the module into place. Please do not overtighten the screw as this might damage the module.

Chapter 3 UEFI Setup Utility

3.1 Introduction

This section explains how to use the UEFI SETUP UTILITY to configure your system. The UEFI chip on the motherboard stores the UEFI SETUP UTILITY. You may run the UEFI SETUP UTILITY when you start up the computer. Please press <F2> or during the Power-On-Self-Test (POST) to enter the UEFI SETUP UTILITY; otherwise, POST will continue with its test routines.

If you wish to enter the UEFI SETUP UTILITY after POST, restart the system by pressing <Ctrl> + <Alt> + <Delete>, or by pressing the reset button on the system chassis. You may also restart by turning the system off and then back on.



Because the UEFI software is constantly being updated, the following UEFI setup screens and descriptions are for reference purpose only, and they may not exactly match what you see on your screen.

3.1.1 UEFI Menu Bar

The top of the screen has a menu bar with the following selections:

Item	Description
Main	To set up the system time/date information
OC Tweaker <i>(for X299 WSI/IPMI only)</i>	For overclocking configurations
Advanced	To set up the advanced UEFI features
Security	To set up the security features
Boot	To set up the default system device to locate and load the Operating System
Server Mgmt	To manage the server
Event Logs	For event log configuration
Exit	To exit the current screen or the UEFI SETUP UTILITY

Use <←→> key or <→> key to choose among the selections on the menu bar, and then press <Enter> to get into the sub screen. You can also use the mouse to click your required item.

3.1.2 Navigation Keys

Please check the following table for the function description of each navigation key.

Navigation Key(s)	Function Description
← / →	Moves cursor left or right to select Screens
↑ / ↓	Moves cursor up or down to select items
+ / -	To change option for the selected items
<Tab>	Switch to next function
<Enter>	To bring up the selected screen
<PGUP>	Go to the previous page
<PGDN>	Go to the next page
<HOME>	Go to the top of the screen
<END>	Go to the bottom of the screen
<F1>	To display the General Help Screen
<F7>	Discard changes and exit the UEFI SETUP UTILITY
<F9>	Load optimal default values for all the settings
<F10>	Save changes and exit the UEFI SETUP UTILITY
<F12>	Print screen
<ESC>	Jump to the Exit Screen or exit the current screen

3.2 Main Screen

Once you enter the UEFI SETUP UTILITY, the Main screen will appear and display the system overview. The Main screen provides system overview information and allows you to set the system time and date.



All screenshots in this document are provided for reference only, and may be different by models. Here is the example of X299 WSI/IPMI interface.

3.3 OC Tweaker Screen *(for X299 WSI/IPMI only)*

In the OC Tweaker screen, you can set up overclocking features.



Because the UEFI software is constantly being updated, the following UEFI setup screens and descriptions are for reference purpose only, and they may not exactly match what you see on your screen.

Load Optimized CPU OC Setting

You can use this option to load optimized CPU overclocking setting. Please note that overclocking may cause damage to your CPU and motherboard. It should be done at your own risk and expense. Please use better CPU cooler for system stability. Red color option may cause system to be unstable, which depends on CPU quality and system environment.

CPU Configuration

Benchmark Tweaker

Set Enabled to optimize the performance of benchmark.

Multi Core Enhancement

Improve the system's performance by forcing the CPU to perform the highest frequency on all CPU cores simultaneously. Disable to reduce power consumption .

CPU Ratio

The CPU speed is determined by the CPU Ratio multiplied with the BCLK. Increasing the CPU Ratio will increase the internal CPU clock speed without affecting the clock speed of other components.

CPU Mesh Max OC Ratio

The sets the maximum overclocking ratio for the CPU Mesh which is in OC Mailbox.

CPU Mesh Max Ratio

The sets the maximum ratio for the CPU Mesh.

CPU Mesh Min Ratio

The sets the minimum ratio for the CPU Mesh.

Flex Ratio

Use this item to set the Flex Ratio.

BCLK Frequency

The CPU speed is determined by the CPU Ratio multiplied with the BCLK. Increasing the BCLK will increase the internal CPU clock speed but also affect the clock speed of other components.

CPU PLL Spread Spectrum

Use this item to select CPU PLL Spread Spectrum.

SRC PLL Spread Spectrum

Use this item to select SRC PLL Spread Spectrum.

ClockGen Advanced Setting

Configure the Clockhen Advanced Setting.

BCLK Step

Configure the BCLK step value.

BCLK Reset Range

Issue a reset when BCLK overclocking exceeds this range.

Stable Delay

Configure the delay time after BCLK settings for stable signals. Unit: 1ms.

CPU BCLK Amplitude

Select BCLK amplitude for ClockGen CPU 0/1/2.

SRC BCLK Amplitude

Select BCLK amplitude for ClockGen SRC 0/1.

SATA BCLK Amplitude

Select BCLK amplitude for SATA.

CPU1 Slew Rate

Adjust the BCLK signal by defining the maximum change rate of the output voltage. Higher values will result in a shorter signal rising time.

CPU2/SRC1 Slew Rate

Adjust the BCLK signal by defining the maximum change rate of the output voltage. Higher values will result in a shorter signal rising time.

SRC0 Slew Rate

Adjust the BCLK signal by defining the maximum change rate of the output voltage. Higher values will result in a shorter signal rising time.

SATA Slew Rate

Adjust the BCLK signal by defining the maximum change rate of the output voltage. Higher values will result in a shorter signal rising time.

CPU PLL ORT

Overshoot Reduction Technology improves the BCLK signal to decrease overshoot/undershoot. Default is Level 3.

PCIE PLL ORT

Overshoot Reduction Technology improves the BCLK signal to decrease overshoot/undershoot. Default is Level 1.

CPU Output Divider

The default is set to 2 where the max BCLK is 1000 MHz, while divider 4 lowers the max BCLK to 500 MHz, while divider 10 lowers the max BCLK to 200 MHz, and divider 1 turns it into 2000 NHz.

SRC Output Divider

The default is set to 2 where the max BCLK is 1000 MHz, while divider 4 lowers the max BCLK to 500 MHz, while divider 10 lowers the max BCLK to 200 MHz, and divider 1 turns it into 2000 NHz.

PCIE Output Divider

The default is set to 2 where the max BCLK is 1000 MHz, while divider 4 lowers the max BCLK to 500 MHz, while divider 10 lowers the max BCLK to 200 MHz, and divider 1 turns it into 2000 NHz.

SRC0 Source

Choose to select the SRC0 source from CPU PLL or PCIE PLL.

CPU2/SRC1 Source

Choose to select the CPU2/SRC1 source from CPU PLL or PCIE PLL.

ClockGen Delay

Delay at beginning of ClockGen; delay Value * 1ms.

BCLK Strap

Choose to select corresponding straps for BCLK.

Boot Performance Mode

Select the performance state that the BIOS will set before OS handoff.

Intel Turbo Boost Technology

Intel Turbo Boost Technology enables the processor to run above its base operating frequency when the operating system requests the highest performance state.

Intel SpeedStep Technology

Intel SpeedStep technology allows processors to switch between multiple frequencies and voltage points for better power saving and heat dissipation.

Intel Speed Shift Technology

Disable: Hardware chooses a P-state based on OS Request (Legacy P-States)

Native Mode: Hardware chooses a P-state based on OS guidance

Out of Band Mode: Hardware autonomously chooses a P-state (no OS guidance)

Intel Turbo Boost Max Technology 3.0

Processors supporting the Intel Turbo Boost Max Technology 3.0 feature contain at least one processor core whose maximum turbo frequency is higher than the others.

Adjust Pll

Adjust the Pll for higher-BCLK ratio combination.

Pll Trim

Change Pll value between +63 to -63.

PLL Trim Prefix

Change PLL Trem prefix.

Pll Trim for Memory Controller

Change Pll Trim value for memory controller between +63 to -63

Pll Trim Prefix for Memory Controller

Change Pll Trim prefix for memory controller.

TJ-Max offset

Set CPU Tj Max to adjust TCC Target Temperature (0°C-125°C). Default is 105°C.

AVX2 Negative Offset

AVX2 Negative Offset applied by Pcode OC mailbox read(0x1A)/Write(0x1B).

AVX3 Negative Offset

AVX3 Negative Offset applied by Pcode OC mailbox read(0x1A)/Write(0x1B).

Primary Plane Current Limit

Configure the current limit of the CPU under Turbo Mode in ampere. A lower limit can protect the CPU and save power, while a higher limit may improve performance.

Long Duration Power Limit

Configure Package Power Limit 1 in watts. When the limit is exceeded, the CPU ratio will be lowered after a period of time. A lower limit can protect the CPU and save power, while a higher limit may improve performance.

Long Duration Maintained

Configure the period of time until the CPU ratio is lowered when the Long Duration Power Limit is exceeded.

Short Duration Power Limit

Configure Package Power Limit 2 in watts. When the limit is exceeded, the CPU ratio will be lowered immediately. A lower limit can protect the CPU and save power, while a higher limit may improve performance.

DRAM Configuration

DRAM Preset

Choose DRAM presets for different brands of DIMMs.

BCLK Frequency

The CPU speed is determined by the CPU Ratio multiplied with the BCLK. Increasing the BCLK will increase the internal CPU clock speed but also affect the clock speed of other components.

DRAM Reference Clock

Select Auto for optimized settings.

DRAM Frequency

If [Auto] is selected, the motherboard will detect the memory module(s) inserted and assign the appropriate frequency automatically.

Primary Timing

CAS# Latency (tCL)

The time between sending a column address to the memory and the beginning of the data in response.

RAS# to CAS# Delay (tRCD)

The number of clock cycles required between the opening of a row of memory and accessing columns within it.

Row Precharge Time (tRP)

The number of clock cycles required between the issuing of the precharge command and opening the next row.

RAS# Active Time (tRAS)

The number of clock cycles required between a bank active command and issuing the precharge command.

Command Rate (CR)

The delay between when a memory chip is selected and when the first active command can be issued.

Secondary Timing

Write Recovery Time (tWR)

The amount of delay that must elapse after the completion of a valid write operation, before an active bank can be precharged.

Refresh Cycle Time (tRFC)

The number of clocks from a Refresh command until the first Activate command to the same rank.

RAS to RAS Delay (tRRD)

The number of clocks between two rows activated in different banks of the same rank.

RAS to RAS Delay (tRRD_L)

The number of clocks between two rows activated in different banks of the same rank.

Write to Read Delay (tWTR)

The number of clocks between the last valid write operation and the next read command to the same internal bank.

Write to Read Delay (tWTR_L)

The number of clocks between the last valid write operation and the next read command to the same internal bank.

Read to Precharge (tRTP)

The number of clocks that are inserted between a read command to a row pre-charge command to the same rank.

Four Activate Window (tFAW)

The time window in which four activates are allowed the same rank.

CAS Write Latency (tCWL)

Configure CAS Write Latency.

Third Timing

tREFI

Configure refresh cycles at an average periodic interval.

tCKE

Configure the period of time the DDR4 initiates a minimum of one refresh command internally once it enters Self-Refresh mode.

tCCCD

Configure back to back CAS to CAS (i.e. READ to RAED or WRITE to WRITE) from same rank separation parameter.

tCCCD_L

Configure back to back CAS to CAS (i.e. READ to RAED or WRITE to WRITE)

from same rank separation parameter.

tCCCD_WR_L

Configure back to back CAS to CAS (i.e. READ to RAED or WRITE to WRITE) from same rank separation parameter.

tRRDS

Configure Back to back READ to READ from different subranks within the same logical rank separation parameter for LRDIMM.

tRRDS_L

Configure Back to back READ to READ from different subranks within the same logical rank separation parameter for LRDIMM.

tRRDR

Configure Read to Read different rank dead cycle Back to back READ to WRITE from different DIMM separation parameter.

tRRDD

Configure Read to Read different DIMM dead cycle Back to back READ to WRITE from different DIMM separation parameter.

tRWSR

Configure READ to WRITE same rank dead cycle Back to back READ to WRITE from same rank separation parameter.

tRWDS

Configure Back to back READ to WRITE from different subranks within the same logical rank separation parameter for LRDIMM.

tRWDR

Configure Back to back READ to WRITE from different ranks separation parameter.

tRWDD

Configure Back to back READ to WRITE from different dimm separation parameter.

tWRDS

Back to back WRITE to READ from different subbanks within the same logical rank separation parameter for LRDIMM. Min: 1 Max: 31

tWRDR

Back to back WRITE to READ from different RANK separation parameter.

tWRDD

Configure Write to Read different DIMM dead cycle Back to back READ to WRITE from different DIMM separation parameter.

tWWDS

Configure Back to back WRITE to WRITE from different subbanks within the same logical rank separation parameter for LRDIMM.

tWWDS_L

Configure Back to back WRITE to WRITE from different subbanks within the same logical rank separation parameter for LRDIMM.

tWWDR

Configure Write to Write different rank dead cycle Back to back READ to WRITE from different rank separation parameter.

tWWDD

Configure Write to Write different DIMM dead cycle Back to back READ to WRITE from different DIMM separation parameter.

Fourth Timing

RTL (A1)

Configure round trip latency.

RTL (A2)

Configure round trip latency.

RTL (B1)

Configure round trip latency.

RTL (B2)

Configure round trip latency.

RTL (C1)

Configure round trip latency.

RTL (C2)

Configure round trip latency.

RTL (D1)

Configure round trip latency.

RTL (D2)

Configure round trip latency.

IO-L (A1)

Configure IO latency.

IO-L (A2)

Configure IO latency.

IO-L (B1)

Configure IO latency.

IO-L (B2)

Configure IO latency.

IO-L (C1)

Configure IO latency.

IO-L (C2)

Configure IO latency.

IO-L (D1)

Configure IO latency.

IO-L (D2)

Configure IO latency.

Advanced Setting

ODT WR (A1)

Configure the memory on die termination resistors' WR for A1.

ODT WR (A2)

Configure the memory on die termination resistors' WR for A2.

ODT WR (B1)

Configure the memory on die termination resistors' WR for B1.

ODT WR (B2)

Configure the memory on die termination resistors' WR for B2.

ODT WR (C1)

Configure the memory on die termination resistors' WR for C1.

ODT WR (C2)

Configure the memory on die termination resistors' WR for C2.

ODT WR (D1)

Configure the memory on die termination resistors' WR for D1.

ODT WR (D2)

Configure the memory on die termination resistors' WR for D2.

ODT PARK (A1)

Configure the memory on die termination resistors' PARK for A1.

ODT PARK (A2)

Configure the memory on die termination resistors' PARK for B2.

ODT PARK (B1)

Configure the memory on die termination resistors' PARK for B1.

ODT PARK (B2)

Configure the memory on die termination resistors' PARK for A2.

ODT PARK (C1)

Configure the memory on die termination resistors' PARK for C1.

ODT PARK (C2)

Configure the memory on die termination resistors' PARK for C2.

ODT PARK (D1)

Configure the memory on die termination resistors' PARK for D1.

ODT PARK (D2)

Configure the memory on die termination resistors' PARK for D2.

ODT NOM (A1)

Use this to change ODT (A1) Auto/Manual settings. The default is [Auto].

ODT NOM (A2)

Use this to change ODT (A2) Auto/Manual settings. The default is [Auto].

ODT NOM (B1)

Use this to change ODT (B1) Auto/Manual settings. The default is [Auto].

ODT NOM (B2)

Use this to change ODT (B2) Auto/Manual settings. The default is [Auto].

ODT NOM (C1)

Use this to change ODT (C1) Auto/Manual settings. The default is [Auto].

ODT NOM (C2)

Use this to change ODT (C2) Auto/Manual settings. The default is [Auto].

ODT NOM (D1)

Use this to change ODT (D1) Auto/Manual settings. The default is [Auto].

ODT NOM (D2)

Configure the memory on die termination resistors' NOM for channel D2.

C/A Parity

[Enable] - Enables DDR4 Command Address Parity.

[Disable] - Disables this feature.

[Auto] - Sets it to the MRC default setting; current default is Disable.

Round Trip Latency Optimize

Configure the Round Trip Latency Optimize setting. The default is [Auto].

MRC Promote Warnings

Determines if MRC warnings are promoted to system level.

Promote Warnings

Determines if warnings are promoted to system level.

Halt on mem Training Error

Enable/Disable Halt on mem Training Error.

Memory Test

Enable/Disable memory test during normal boot.

MemTestLoops

Number of memory test loops during normal boot, set to 0 to run memtest infinitely.

Mem Test On Fast Boot

Enable/Disable memory test during fast boot.

Attempt Fast Boot

[Enable] - Portions of memory reference code will be skipped when possible to increase boot speed on warm boots.

[Disable] - Disable this feature.

[Auto] - Sets it to the MRC default setting; current default is Disable.

Attempt Fast Cold Boot

[Enable] - Portions of memory reference code will be skipped when possible to increase boot speed on cold boots.

[Disable] - Disable this feature.

[Auto] - Sets it to the MRC default setting; current default is Disable.

Voltage Configuration

CPU Input Voltage

Input voltage for the processor by the external voltage regulator.

CPU Load-Line Calibration

CPU Load-Line Calibration helps prevent CPU voltage droop when the system is under heavy loading.

DRAM AB Voltage

Configure the voltage for the DRAM on channel A, B.

DRAM CD Voltage

Configure the voltage for the DRAM on channel C, D.

1.0 PCH Voltage

Configure the voltage for Chipset 1.0V.

VCCIO Voltage

Configure the voltage for the VCCIO.

VCCSA Voltage

Configure the voltage for the VCCSA.

FIVR Configuration

CPU Vcore Voltage Mode

Configure the amount of voltage fed to the cores for the processor. Increase the voltage when increasing CPU Core Frequency.

Auto: For optimized settings.

Adaptive: Add voltage to the CPU when the system is under heavy loading.

Override: The voltage is fixed.

Vcore Voltage Additional Offset

Configure the dynamic Vcore voltage added to the Vcore. Max = 1.000V

Offset Prefix

Sets the offset value as positive or negative.

CPU Mesh Voltage Mode

Configure the amount of voltage fed to the UNCores fo the processor including its cache. Increase the voltage when increasing CPU Mesh Frequency.

Auto: For optimized settings.

Adaptive: Add voltage to the CPU Mesh when the system is under heavy loading.

Override: The voltage is fixed.

CPU Mesh Voltage Offset

Configure the voltage for the CPU Mesh Voltage Offset(V).

Min = -1.000V

Max = 1.000V

Offset Prefix

Sets the offset value as positive or negative.

System Agent Voltage Offset

Configure the amount of voltage fed to the System Agent of the processor including its PCIe controller and Power control Unit (PCU). Setting the voltage higher may increase system stability when overclocking the memory.

Min = -1.000V

Max = 1.000V

Offset Prefix

Sets the offset value as positive or negative.

VCCU Voltage Offset

Configure the VCCU Voltage.

Min = -1.000V

Max = 1.000V

Offset Prefix

Sets the offset value as positive or negative.

CPU Integrated VR Faults

Disable FIVR Faults to raise the threshold to trigger CPU over current protection and over voltage protection for better overclocking capabilities

CPU Integrated VR Efficiency Mode

Enable FIVR Efficiency Management for power saving. Disable for better performance and overclocking capabilities.

SVID Support

Enable/Disable SVID. Disabling SVID disables input voltage overrides.

3.4 Advanced Screen

In this section, you may set the configurations for the following items: CPU Configuration, IIO Configuration, Chipset Configuration, Storage Configuration, Super IO Configuration, Serial Port Console Redirection, H/W Monitor, Intel ME Information, ACPI Configuration, USB Configuration and Instant Flash.

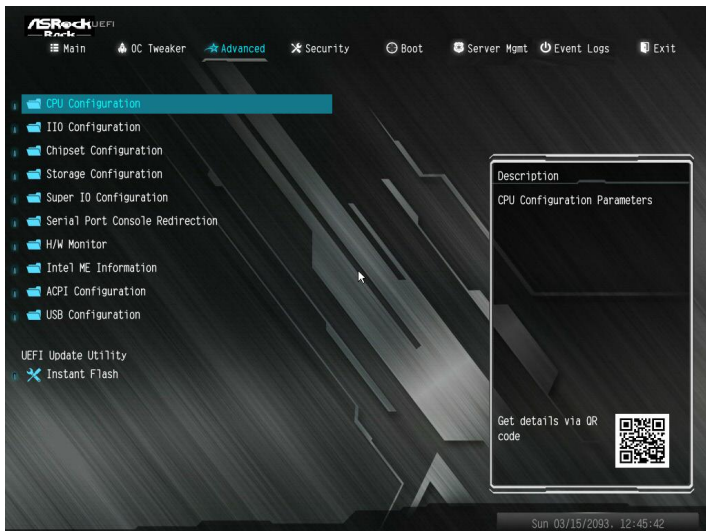

Setting wrong values in this section may cause the system to malfunction.

3.4.1 CPU Configuration



Intel Hyper-Threading Technology

Intel Hyper-Threading Technology allows multiple threads to run on each core, so that the overall performance on threaded software is improved.

Active Processor Cores

Select the number of cores to enable in each processor package.

CPU C States Support

Enable CPU C States Support for power saving. It is recommended to keep C3, C6 and C7 all enabled for better power saving.

CPU Thermal Throttling

Enable CPU internal thermal control mechanisms to keep the CPU from overheating.

No-Execute Memory Protection

Processors with No-Execution Memory Protection Technology may prevent certain classes of malicious buffer overflow attacks.

Intel Virtualization Technology

Intel Virtualization Technology allows a platform to run multiple operating systems and applications in independent partitions, so that one computer system can function as

multiple virtual systems.

Intel Safer Mode Extensions (SMX)

Safer Mode Extensions (SMX) provide a means for system software to launch an MLE and establish a measured environment within the platform to support trust decisions by end users.

DCU Streamer Prefetcher

DCU streamer prefetcher is an L1 data cache prefetcher (MSR 1A4h [2]).

Hardware Prefetcher

Automatically prefetch data and code for the processor. Enable for better performance.

Adjacent Cache Line Prefetch

Automatically prefetch the subsequent cache line while retrieving the currently requested cache line. Enable for better performance.

3.4.2 IIO Configuration

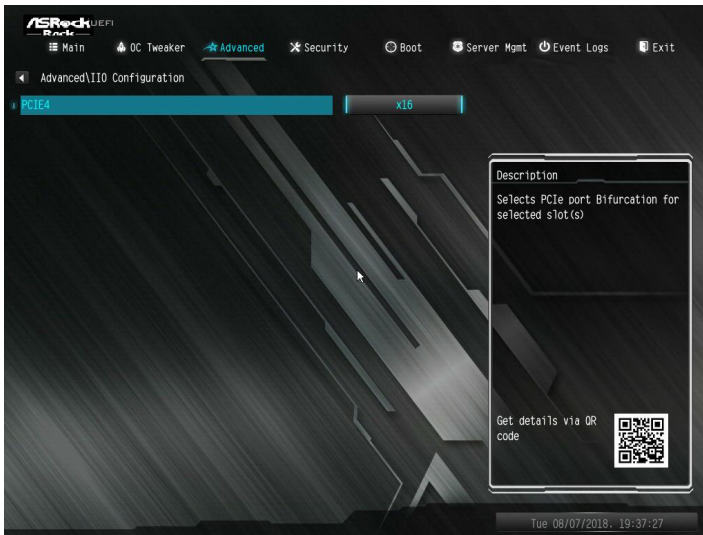

PCIe4

This allows you to select PCIe port Bifurcation for selected slots(s).

3.4.3 Chipset Configuration



Above 4GB MMIO BIOS Assignment

Enable/Disable above 4GB MemoryMappedIO BIOS assignment. This is disabled automatically when Aperture Size is set to 2048MB.

VT-d

Intel Virtualization Technology for Directed I/O helps your virtual machine monitor better utilize hardware by improving application compatibility and reliability, and providing additional levels of manageability, security, isolation, and I/O performance.

Primary Graphics Adapter

Select the type of primary VGA in case of multiple video controllers.

Onboard VGA

Use this item to Enable or Disable Onboard VGA.

Onboard LAN

Use this item to Enable or Disable Onboard LAN.

PCIE4 Link Speed

This allows you to select PCIE4 Link Speed. The default value is [Auto].

OCU1 Link Speed

This allows you to configure OCU1 Slot Link Speed. Auto mode is optimizing for overclocking.

PCIE ASPM Support

This option enables or disables the ASPM support for all CPU downstream devices.

PCH PCIE ASPM Support

This option enables or disables the ASPM support for all PCH downstream devices.

PCH DMI ASPM Support

This option enables/disables the ASPM support for all PCH DMI devices.

Restore AC Power Loss

Select the power state after a power failure. If [Power Off] is selected, the power will remain off when the power recovers. If [Power On] is selected, the system will start to boot up when the power recovers.

Restore AC Power Current State

This allows you to restore AC Power Current State.

3.4.4 Storage Configuration



SATA Controller(s)

Use this item to enable or disable SATA Controllers.

SATA/M.2_SATA Mode Selection

Identify the SATA/M.2_SATA port is connected to Solid State Drive or Hard Disk Drive. Press <Ctrl+I> to enter RAID ROM during UEFI POST process.

SATA Aggressive Link Power Management

Use this item to enable or disable SALP.

Hard Disk S.M.A.R.T.

Use this item to enable or disable the S.M.A.R.T. (Self-Monitoring, Analysis, and Reporting Technology) feature. Configuration options: [Disabled] and [Enabled].

Intel VMD Technology

Intel VMD Support for IOU2 (PCIe4)

Enable/Disable Intel Volume Management Device Technology.

3.4.5 Super IO Configuration

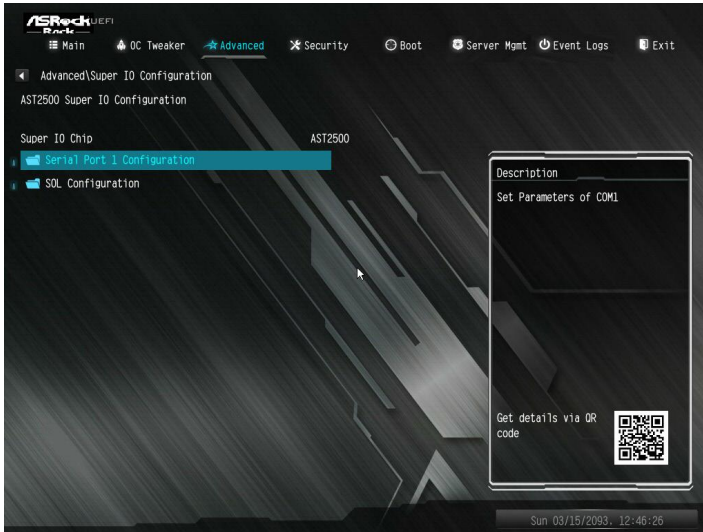

Serial Port 1 Configuration

Use this item to set parameters of Serial Port 1 (COM1).

Serial Port

Use this item to enable or disable the serial port.

Change Settings

Use this item to select an optimal setting for Super IO device.

SOL Configuration

Use this item to set parameters of SOL.

SOL Port

Use this item to set parameters of SOL.

Change Settings

Use this item to select an optimal setting for Super IO device.

3.4.6 Serial Port Console Redirection

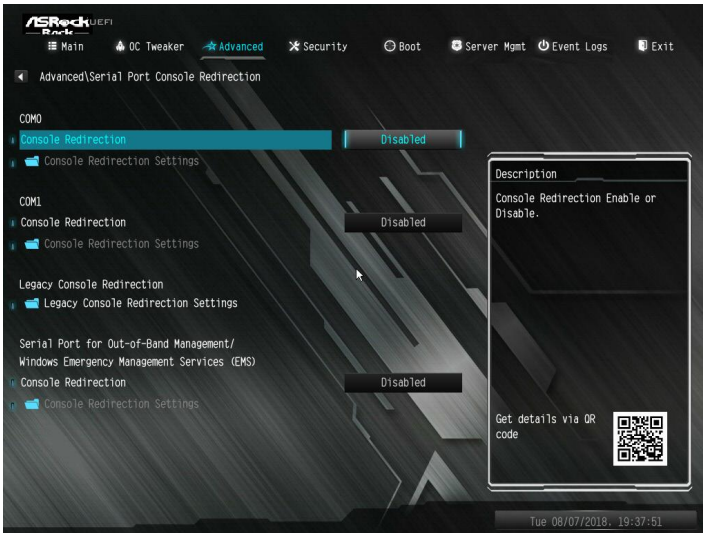

COM0 / COM1

Console Redirection

Use this option to enable or disable Console Redirection. If this item is set to Enabled, you can select a COM Port to be used for Console Redirection.

Console Redirection Settings

Use this option to configure Console Redirection Settings, and specify how your computer and the host computer to which you are connected exchange information.

Terminal Type

Use this item to select the preferred terminal emulation type for out-of-band management. It is recommended to select [VT-UTF8].

Option	Description
VT100	ASCII character set
VT100+	Extended VT100 that supports color and function keys
VT-UTF8	UTF8 encoding is used to map Unicode chars onto 1 or more bytes
ANSI	Extended ASCII character set

Bits Per Second

Use this item to select the serial port transmission speed. The speed used in the host computer and the client computer must be the same. Long or noisy lines may require lower transmission speed. The options include [9600], [19200], [38400], [57600] and [115200].

Data Bits

Use this item to set the data transmission size. The options include [7] and [8] (Bits).

Parity

Use this item to select the parity bit. The options include [None], [Even], [Odd], [Mark] and [Space].

Stop Bits

The item indicates the end of a serial data packet. The standard setting is [1] Stop Bit. Select [2] Stop Bits for slower devices.

Flow Control

Use this item to set the flow control to prevent data loss from buffer overflow. When sending data, if the receiving buffers are full, a "stop" signal can be sent to stop the data flow. Once the buffers are empty, a "start" signal can be sent to restart the flow. Hardware flow uses two wires to send start/stop signals. The options include [None] and [Hardware RTS/CTS].

VT-UTF8 Combo Key Support

Use this item to enable or disable the VT-UTF8 Combo Key Support for ANSI/VT100 terminals.

Recorder Mode

Use this item to enable or disable Recorder Mode to capture terminal data and send it as text messages.

Resolution 100x31

Use this item to enable or disable extended terminal resolution support.

Legacy OS Redirection Resolution

Use this item to select the number of rows and columns used in legacy OS redirection.

Putty Keypad

Use this item to select Function Key and Keypad on Putty.

Redirection After BIOS POST

If the [LoadBooster] is selected, legacy console redirection is disabled before booting to legacy OS. If [Always Enabled] is selected, legacy console redirection is enabled for legacy OS. The default value is [Always Enabled].

Legacy Console Redirection

Legacy Console Redirection Settings

Use this option to configure Legacy Console Redirection Settings, and specify how your computer and the host computer to which you are connected exchange information.

Legacy Serial Redirection Port

Use this item to select a COM port to display redirection of Legacy OS and Legacy OPROM Messages.

Serial Port for Out-of-Band Management/Windows Emergency Management Services (EMS)

Console Redirection

Use this option to enable or disable Console Redirection. If this item is set to Enabled, you can select a COM Port to be used for Console Redirection.

Console Redirection Settings

Use this option to configure Console Redirection Settings, and specify how your computer and the host computer to which you are connected exchange information.

Terminal Type

Use this item to select the preferred terminal emulation type for out-of-band management. It is recommended to select [VT-UTF8].

Option	Description
VT100	ASCII character set
VT100+	Extended VT100 that supports color and function keys
VT-UTF8	UTF8 encoding is used to map Unicode chars onto 1 or more bytes
ANSI	Extended ASCII character set

Bits Per Second

Use this item to select the serial port transmission speed. The speed used in the host computer and the client computer must be the same. Long or noisy lines may require lower transmission speed. The options include [9600], [19200], [57600] and [115200].

Flow Control

Use this item to set the flow control to prevent data loss from buffer overflow. When sending data, if the receiving buffers are full, a "stop" signal can be sent to stop the data flow. Once the buffers are empty, a "start" signal can be sent to restart the flow. Hardware flow uses two wires to send start/stop signals. The options include [None], [Hardware RTS/CTS], and [Software Xon/Xoff].

Data Bits

Parity

Stop Bits

3.4.7 H/W Monitor

In this section, it allows you to monitor the status of the hardware on your system, including the parameters of the CPU temperature, motherboard temperature, CPU fan speed, chassis fan speed, and the critical voltage.

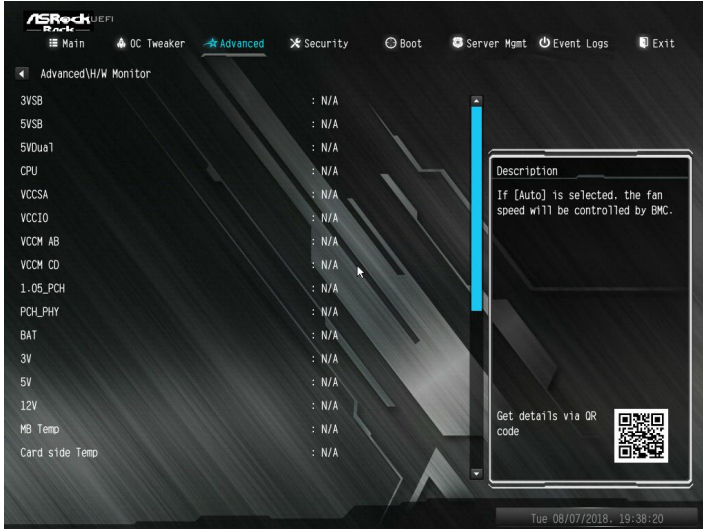

Fan Control

If [Auto] is selected, the fan speed will be controlled by BMC.

If [Manual] is selected, configure the items below.

CPU_FAN1

This allows you to set the CPU fan 1's speed. The default value is [Smart Fan].

FRNT_FAN1

This allows you to set the front fan 1's speed. The default value is [Smart Fan].

FRNT_FAN2

This allows you to set the front fan 2's speed. The default value is [Smart Fan].

Smart Fan Control

This allows you to set the Smart fan's level speed.

Smart Fan Duty Control

Smart Fan Duty x (x means 1 to 11 stage)

This allows you to set duty cycle for each stage.

Smart Fan Temp Control

Smart Fan Temp x (x means 1 to 11 stage)

This allows you to set temperature for each stage.

Watch Dog Timer

This allows you to enable or disable the Watch Dog Timer. The default value is [Disabled]..

3.4.8 Intel ME Information

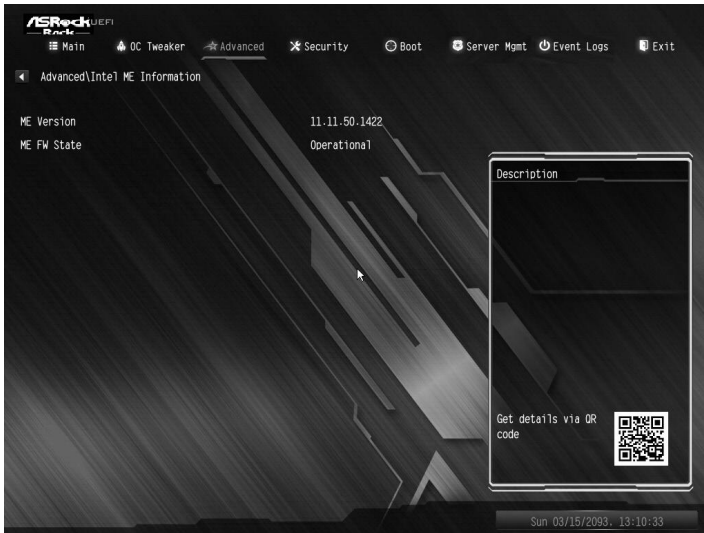

Intel ME Information screen displays the Intel ME Configuration information, such as Operational Firmware Version and Firmware State.

3.4.9 ACPI Configuration



PCIE Devices Power On

Allow the system to be waked up by a PCIE device and enable wake on LAN.

Ring-In Power On

Allow the system to be waked up by onboard COM port modem Ring-In signals.

RTC Alarm Power On

Allow the system to be waked up by the real time clock alarm. Set it to By OS to let it be handled by your operating system.

USB Keyboard/Remote Power On

Allow the system to be waked up by an USB keyboard or remote controller.

USB Mouse Power On

Allow the system to be waked up by an USB mouse.

3.4.10 USB Configuration

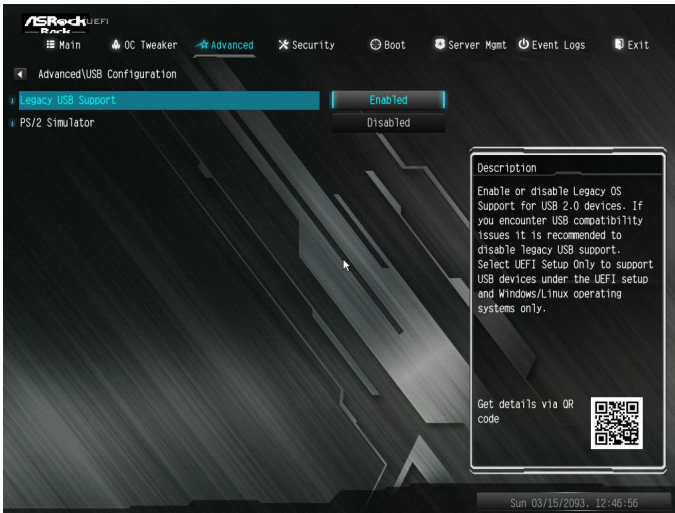

Legacy USB Support

Enable or disable Legacy OS Support for USB 2.0 devices. If you encounter USB compatibility issues it is recommended to disable legacy USB support. Select UEFI Setup Only to support USB devices under the UEFI setup and Windows/Linux operating systems only.

PS/2 Simulator

Enable the support of I/O port 60h/64h emulation. This should be enabled for the complete USB keyboard legacy support for non-USB aware OSes.

3.4.11 Instant Flash

Instant Flash is a UEFI flash utility embedded in Flash ROM. This convenient UEFI update tool allows you to update system UEFI without entering operating systems first like MS-DOS or Windows. Just save the new UEFI file to your USB flash drive, floppy disk or hard drive and launch this tool, then you can update your UEFI only in a few clicks without preparing an additional floppy diskette or other complicated flash utility. Please be noted that the USB flash drive or hard drive must use FAT32/16/12 file system. If you execute Instant Flash utility, the utility will show the UEFI files and their respective information. Select the proper UEFI file to update your UEFI, and reboot your system after the UEFI update process is completed.

3.5 Security

In this section, you may set or change the supervisor/user password for the system. For the user password, you may also clear it.

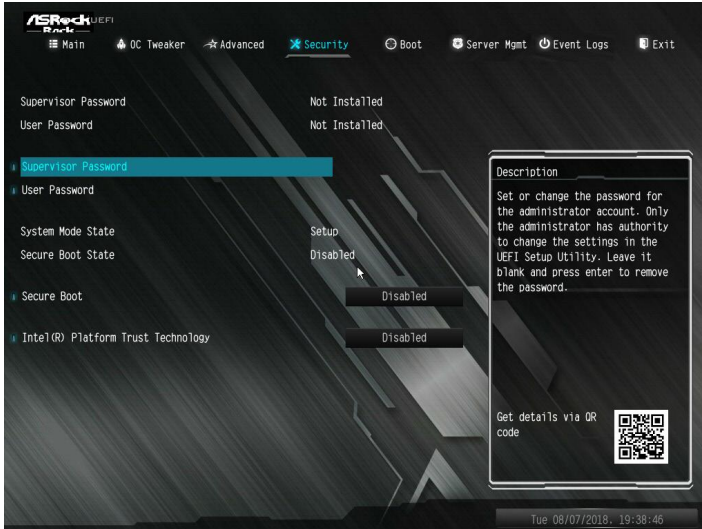

Supervisor Password

Set or change the password for the administrator account. Only the administrator has authority to change the settings in the UEFI Setup Utility. Leave it blank and press enter to remove the password.

User Password

Set or change the password for the user account. Users are unable to change the settings in the UEFI Setup Utility. Leave it blank and press enter to remove the password.

Secure Boot

Use this item to enable or disable support for Secure Boot.

Intel(R) Platform Trust Technology

Enable/disable Intel PTT in ME. Disable this option to use discrete TPM Module.

3.6 Boot Screen

This section displays the available devices on your system for you to configure the boot settings and the boot priority.

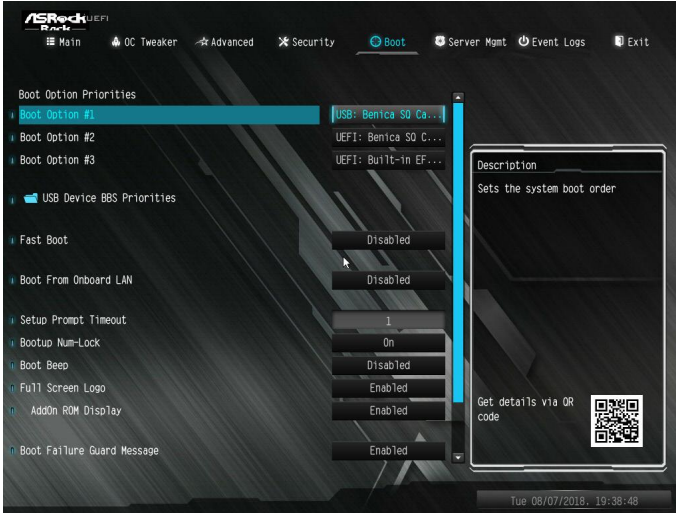

Boot Option #1

Use this item to set the system boot order.

Boot Option #2

Use this item to set the system boot order.

Boot Option #3

Use this item to set the system boot order.

USB Device BBS Priorities

This page will show only when system install USB Storage.

Fast Boot

Fast Boot minimizes your computer's boot time. In fast mode you may not boot from an USB storage device. The VBIOS must support UEFI GOP if you are using an external graphics card. Please notice that Ultra Fast mode will boot so fast that the only way to enter this UEFI Setup Utility is to Clear CMOS or run the Restart to UEFI utility in Windows.

Boot From Onboard LAN

Allow the system to be waked up by the onboard LAN.

Setup Prompt Timeout

Configure the number of seconds to wait for the setup hot key.

Bootup Num-Lock

Select whether Num Lock should be turned on or off when the system boots up.

Boot Beep

Select whether the Boot Beep should be turned on or off when the system boots up. Please note that a buzzer is needed.

Full Screen Logo

Enable to display the boot logo or disable to show normal POST messages.

AddOn ROM Display

Enable AddOn ROM Display to see the AddOn ROM messages or configure the AddOn ROM if you've enabled Full Screen Logo. Disable for faster boot speed.

Boot Failure Guard Message

If the computer fails to boot for a number of times the system automatically restores the default settings.

Boot Failure Guard Count

Configure the number of attempts to boot until the system automatically restores the default settings.

CSM (Compatibility Support Module)

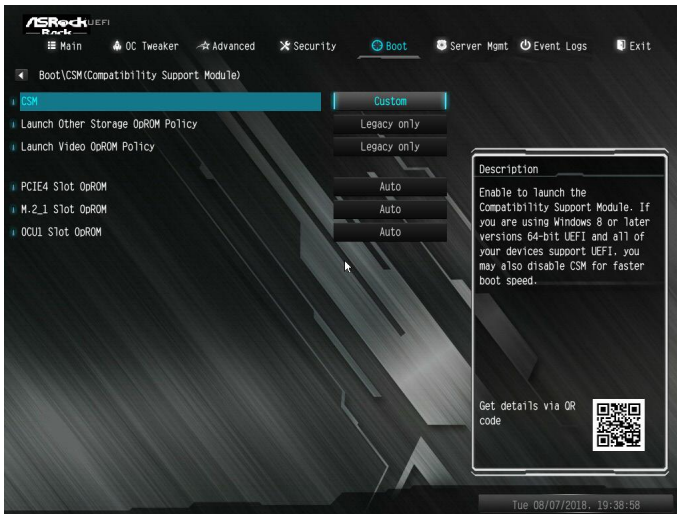

CSM

Enable to launch the Compatibility Support Module. Please do not disable unless you're running a WHCK test.

Launch Other Storage OpROM Policy

Select UEFI only to run those that support UEFI option ROM only. Select Legacy only to run those that support legacy option ROM only. Select Do not launch to not execute both legacy and UEFI option ROM.

Launch Video OpROM Policy

Select UEFI only to run those that support UEFI option ROM only. Select Legacy only to run those that support legacy option ROM only. Select Do not launch to not execute both legacy and UEFI option ROM.

PCIe4 Slot OpROM

Use this item to select slot storage and Network Option ROM policy. In Auto option, the default is Disabled with NVMe device, but it is Legacy with other devices. (This item can't select Video Option ROM policy.)

M.2_1 Slot OpROM

Use this item to select slot storage and Network Option ROM policy. In Auto option, the default is Disabled with NVMe device, but it is Legacy with other devices. (This item can't select Video Option ROM policy.)

OCU1 Slot OpROM

Use this item to select slot storage and Network Option ROM policy. In Auto option, the default is Disabled with NVMe device, but it is Legacy with other devices. (This item can't select Video Option ROM policy.)

3.7 Server Mgmt



Wait For BMC

Wait For BMC response for specified time out. BMC starts at the same time when BIOS starts during AC power ON. It takes around 90 seconds to initialize Host to BMC interfaces.

Inventory Support

This will execute inventory function for system. Enabling this item will take some time at system boot.

3.7.1 System Event Log

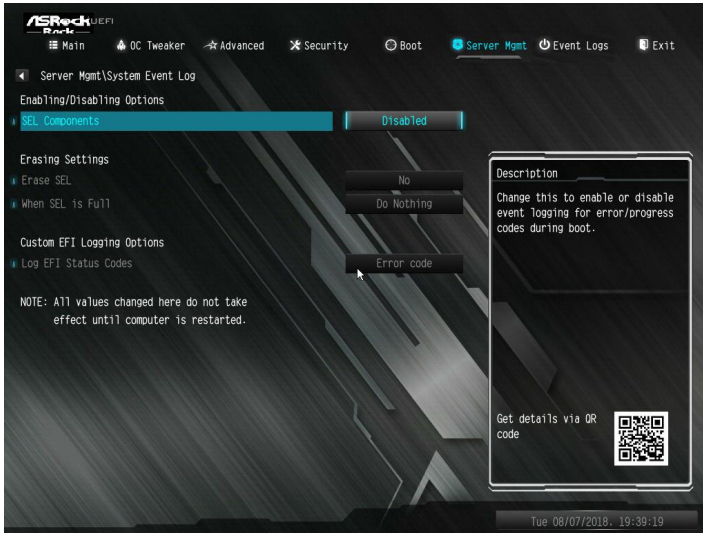

SEL Components

Change this to enable or disable event logging for error/progress codes during boot.

Erase SEL

Use this to choose options for erasing SEL.

When SEL is Full

Use this to choose options for reactions to a full SEL.

Log EFI Status Codes

Use this item to disable the logging of EFI Status Codes or log only error code or only progress code or both.

3.7.2 BMC Network Configuration



BMC Out of Band Access

Enabled/Disabled BMC Out of band Access.

Lan Channel (Failover)

Manual Setting IPMI LAN

If [No] is selected, the IP address is assigned by DHCP. If you prefer using a static IP address, toggle to [Yes], and the changes take effect after the system reboots. The default value is [No].

Configuration Address Source

Select to configure BMC network parameters statically or dynamically (by BIOS or BMC). Configuration options: [Static] and [DHCP].

Static: Manually enter the IP Address, Subnet Mask and Gateway Address in the BIOS for BMC LAN channel configuration.

DHCP: IP address, Subnet Mask and Gateway Address are automatically assigned by the network's DHCP server.



When [DHCP] or [Static] is selected, do NOT modify the BMC network settings on the IPMI web page.

3.8 Event Logs

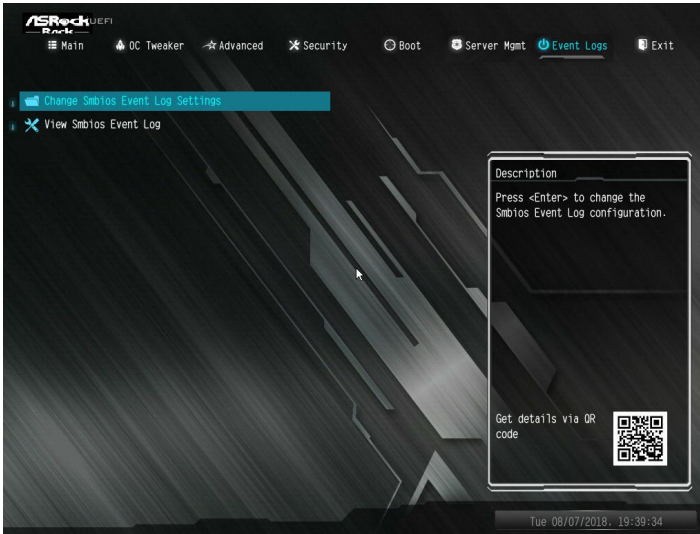

Change Smbios Event Log Settings

This allows you to configure the Smbios Event Log Settings.

When entering the item, you will see the followings:

Smbios Event Log

Use this item to enable or disable all features of the SMBIOS Event Logging during system boot.

Erase Event Log

The options include [No], [Yes, Next reset] and [Yes, Every reset]. If Yes is selected, all logged events will be erased.

When Log is Full

Use this item to choose options for reactions to a full Smbios Event Log. The options include [Do Nothing] and [Erase Immediately].

MECI (Multiple Event Count Increment)

Use this item to enter the increment value for the multiple event counter. The valid range is from 1 to 255.

METW (Multiple Event Time Window)

Use this item to specify the number of minutes which must pass between duplicate log entries which utilize a multiple-event counter. The value ranges from 0 to 99 minutes.

View Smbios Event Log

Press <Enter> to view the Smbios Event Log records.



All values changed here do not take effect until computer is restarted.

3.9 Exit Screen

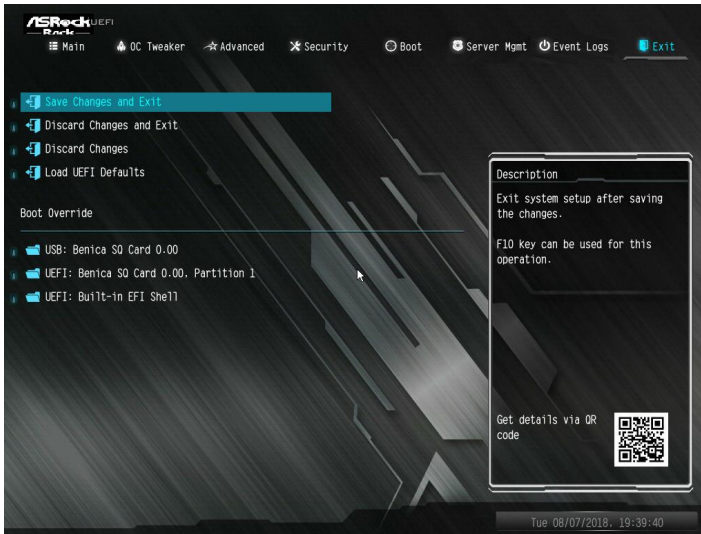

Save Changes and Exit

When you select this option, the following message “Save configuration changes and exit setup?” will pop-out. Press <F10> key or select [Yes] to save the changes and exit the UEFI SETUP UTILITY.

Discard Changes and Exit

When you select this option, the following message “Discard changes and exit setup?” will pop-out. Press <ESC> key or select [Yes] to exit the UEFI SETUP UTILITY without saving any changes.

Discard Changes

When you select this option, the following message “Discard changes?” will pop-out. Press <F7> key or select [Yes] to discard all changes.

Load UEFI Defaults

Load UEFI default values for all the setup questions. F9 key can be used for this operation.

Boot Override

These items displays the available devices. Select an item to start booting from the selected device.

Chapter 4 Software Support

4.1 Install Operating System

This motherboard supports various Microsoft® Windows® /Linux® compliant. Because motherboard settings and hardware options vary, use the setup procedures in this chapter for general reference only. Refer to your OS documentation for more information.

**Please download the Intel® SATA Floppy Image driver from the ASRock Rack's website (www.asrockrack.com) to your USB drive or simply install the SATA driver from the Support CD while installing OS in SATA RAID mode.*

4.2 Support CD Information

The Support CD that came with the motherboard contains necessary drivers and useful utilities that enhance the motherboard's features.

4.2.1 Running The Support CD

To begin using the support CD, insert the CD into your CD-ROM drive. The CD automatically displays the Main Menu if "AUTORUN" is enabled in your computer. If the Main Menu does not appear automatically, locate and double click on the file "ASRSetup.exe" from the root folder in the Support CD to display the menu.

4.2.2 Drivers Menu

The Drivers Menu shows the available device's drivers if the system detects installed devices. Please install the necessary drivers to activate the devices.

4.2.3 Utilities Menu

The Utilities Menu shows the application softwares that the motherboard supports. Click on a specific item then follow the installation wizard to install it.

4.2.4 Contact Information

If you need to contact ASRock Rack or want to know more about ASRock Rack, welcome to visit ASRock Rack's website at <http://www.ASRockRack.com>; or you may contact your dealer for further information.

Chapter 5 Troubleshooting

5.1 Troubleshooting Procedures

Follow the procedures below to troubleshoot your system.



Always unplug the power cord before adding, removing or changing any hardware components. Failure to do so may cause physical injuries to you and damages to motherboard components.

1. Disconnect the power cable and check whether the PWR LED is off.
2. Unplug all cables, connectors and remove all add-on cards from the motherboard.
Make sure that the jumpers are set to default settings.
3. Confirm that there are no short circuits between the motherboard and the chassis.
4. Install a CPU and fan on the motherboard, then connect the chassis speaker and power LED.

If there is no power...

1. Confirm that there are no short circuits between the motherboard and the chassis.
2. Make sure that the jumpers are set to default settings.
3. Check the settings of the 115V/230V switch on the power supply.
4. Verify if the battery on the motherboard provides ~3VDC. Install a new battery if it does not.

If there is no video...

1. Try replugging the monitor cables and power cord.
2. Check for memory errors.

If there are memory errors...

1. Verify that the DIMM modules are properly seated in the slots.
2. Use recommended DDR4 SO-DIMMs.
3. If you have installed more than one DIMM modules, they should be identical with the same brand, speed, size and chip-type.
4. Try inserting different DIMM modules into different slots to identify faulty ones.
5. Check the settings of the 115V/230V switch on the power supply.

Unable to save system setup configurations...

1. Verify if the battery on the motherboard provides ~3VDC. Install a new battery if it does not.
2. Confirm whether your power supply provides adequate and stable power.

Other problems...

1. Try searching keywords related to your problem on ASRock Rack's FAQ page:
<http://www.asrockrack.com/support>

5.2 Technical Support Procedures

If you have tried the troubleshooting procedures mentioned above and the problems are still unsolved, please contact ASRock Rack's technical support with the following information:

1. Your contact information
2. Model name, BIOS version and problem type.
3. System configuration.
4. Problem description.

You may contact ASRock Rack's technical support at:

<http://www.asrockrack.com/support/tsd.asp>

5.3 Returning Merchandise for Service

For warranty service, the receipt or a copy of your invoice marked with the date of purchase is required. By calling your vendor or going to our RMA website (<http://event.asrockrack.com/tsd.asp>) you may obtain a Returned Merchandise Authorization (RMA) number.

The RMA number should be displayed on the outside of the shipping carton which is mailed prepaid or hand-carried when you return the motherboard to the manufacturer. Shipping and handling charges will be applied for all orders that must be mailed when service is complete.

This warranty does not cover damages incurred in shipping or from failure due to alteration, misuse, abuse or improper maintenance of products.

Contact your distributor first for any product related problems during the warranty period.